



Where Automation Connects.



**inRAX**<sup>®</sup>

**MVI69-GEC**

**CompactLogix or MicroLogix  
Platform**

Generic ASCII Ethernet  
Communication Module

October 8, 2010

**USER MANUAL**

## **Your Feedback Please**

We always want you to feel that you made the right decision to use our products. If you have suggestions, comments, compliments or complaints about our products, documentation, or support, please write or call us.

## **How to Contact Us**

### **ProSoft Technology**

5201 Truxtun Ave., 3rd Floor

Bakersfield, CA 93309

+1 (661) 716-5100

+1 (661) 716-5101 (Fax)

[www.prosoft-technology.com](http://www.prosoft-technology.com)

[support@prosoft-technology.com](mailto:support@prosoft-technology.com)

**Copyright © 2010 ProSoft Technology, Inc., all rights reserved.**

MVI69-GEC User Manual

October 8, 2010

ProSoft Technology<sup>®</sup>, ProLinX<sup>®</sup>, inRAx<sup>®</sup>, ProTalk<sup>®</sup>, and RadioLinX<sup>®</sup> are Registered Trademarks of ProSoft Technology, Inc. All other brand or product names are or may be trademarks of, and are used to identify products and services of, their respective owners.

## **ProSoft Technology<sup>®</sup> Product Documentation**

In an effort to conserve paper, ProSoft Technology no longer includes printed manuals with our product shipments. User Manuals, Datasheets, Sample Ladder Files, and Configuration Files are provided on the enclosed CD-ROM, and are available at no charge from our web site: [www.prosoft-technology.com](http://www.prosoft-technology.com)

Printed documentation is available for purchase. Contact ProSoft Technology for pricing and availability.

North America: +1.661.716.5100

Asia Pacific: +603.7724.2080

Europe, Middle East, Africa: +33 (0) 5.3436.87.20

Latin America: +1.281.298.9109

## Important Installation Instructions

Power, Input, and Output (I/O) wiring must be in accordance with Class I, Division 2 wiring methods, Article 501-4 (b) of the National Electrical Code, NFPA 70 for installation in the U.S., or as specified in Section 18-1J2 of the Canadian Electrical Code for installations in Canada, and in accordance with the authority having jurisdiction. The following warnings must be heeded:

- A** WARNING - EXPLOSION HAZARD - SUBSTITUTION OF COMPONENTS MAY IMPAIR SUITABILITY FOR CLASS I, DIV. 2;
- B** WARNING - EXPLOSION HAZARD - WHEN IN HAZARDOUS LOCATIONS, TURN OFF POWER BEFORE REPLACING OR WIRING MODULES
- C** WARNING - EXPLOSION HAZARD - DO NOT DISCONNECT EQUIPMENT UNLESS POWER HAS BEEN SWITCHED OFF OR THE AREA IS KNOWN TO BE NON-HAZARDOUS.
- D** THIS DEVICE SHALL BE POWERED BY CLASS 2 OUTPUTS ONLY.

## MVI (Multi Vendor Interface) Modules

WARNING - EXPLOSION HAZARD - DO NOT DISCONNECT EQUIPMENT UNLESS POWER HAS BEEN SWITCHED OFF OR THE AREA IS KNOWN TO BE NON-HAZARDOUS.

AVERTISSEMENT - RISQUE D'EXPLOSION - AVANT DE DÉCONNECTER L'ÉQUIPEMENT, COUPER LE COURANT OU S'ASSURER QUE L'EMPLACEMENT EST DÉSIGNÉ NON DANGEREUX.

## Warnings

### North America Warnings

- A** Warning - Explosion Hazard - Substitution of components may impair suitability for Class I, Division 2.
- B** Warning - Explosion Hazard - When in hazardous locations, turn off power before replacing or rewiring modules.  
Warning - Explosion Hazard - Do not disconnect equipment unless power has been switched off or the area is known to be non-hazardous.
- C** Suitable for use in Class I, Division 2 Groups A, B, C and D Hazardous Locations or Non-Hazardous Locations.

### ATEX Warnings and Conditions of Safe Usage

Power, Input, and Output (I/O) wiring must be in accordance with the authority having jurisdiction.

- A** Warning - Explosion Hazard - When in hazardous locations, turn off power before replacing or wiring modules.
- B** Warning - Explosion Hazard - Do not disconnect equipment unless power has been switched off or the area is known to be non-hazardous.
- C** These products are intended to be mounted in an IP54 enclosure. The devices shall provide external means to prevent the rated voltage being exceeded by transient disturbances of more than 40%. This device must be used only with ATEX certified backplanes.
- D** DO NOT OPEN WHEN ENERGIZED.

**Warning: This module is not hot-swappable!** Always remove power from the rack before inserting or removing this module, or damage may result to the module, the processor, or other connected devices.

## Battery Life Advisory

The MVI46, MVI56, MVI56E, MVI69, and MVI71 modules use a rechargeable Lithium Vanadium Pentoxide battery to backup the real-time clock and CMOS. The battery should last for the life of the module. The module must be powered for approximately twenty hours before the battery becomes fully charged. After it is fully charged, the battery provides backup power for the CMOS setup and the real-time clock for approximately 21 days. When the battery is fully discharged, the module will revert to the default BIOS and clock settings.

**Note:** The battery is not user replaceable.

## Markings

### Electrical Ratings

- Backplane Current Load: 800 mA @ 5.1 Vdc
- Power Supply Distance Rating: 2
- Operating Temperature: 0 °C to 60 °C (32 °F to 140 °F)
- Storage Temperature: -40 °C to 85 °C (-40 °F to 185 °F)
- Relative Humidity: 5% to 95% (without condensation)
- All phase conductor sizes must be at least 1.3 mm(squared) and all earth ground conductors must be at least 4mm(squared).

### Label Markings

Class I, Division 2 Groups A, B, C, D

II 3 G

Ex nA IIC X

0 °C ≤ Ta ≤ +60 °C

II - Equipment intended for above ground use (not for use in mines).

3 - Category 3 equipment, investigated for normal operation only.

G - Equipment protected against explosive gasses.

### Agency Approvals and Certifications

Agency	Applicable Standard(s)
ATEX	EN 60079-0:2006, EN 60079-15:2005
DNV	DET NORSKE VERITAS Test 2.4
CE	EMC-EN61326-1:2006; EN61000-6-4:2007
CB Safety	CA/10533/CSA, IEC 61010-1 Ed. 2, CB 243333-2056722 (2090408)
GOST-R	EN 61010



ME06

# Contents

Your Feedback Please .....	2
How to Contact Us .....	2
ProSoft Technology® Product Documentation .....	2
Important Installation Instructions .....	3
MVI (Multi Vendor Interface) Modules .....	3
Warnings .....	3
Battery Life Advisory .....	3
Markings.....	4

## **Guide to the MVI69-GEC User Manual** **7**

### **1 Start Here** **9**

1.1	System Requirements .....	10
1.2	Package Contents .....	11
1.3	Installing ProSoft Configuration Builder Software .....	12
1.4	Setting Jumpers .....	13
1.5	Installing the Module in the Rack .....	14
1.6	Connecting Your PC to the Processor .....	17
1.7	Downloading the Sample Program to the Processor .....	18
1.7.1	Configuring the RSLinx Driver for the PC COM Port .....	19
1.8	Connecting Your PC to the Module.....	21

### **2 Configuring the MVI69-GEC Module** **23**

2.1	Using ProSoft Configuration Builder .....	24
2.1.1	Setting Up the Project .....	24
2.1.2	Renaming PCB Objects .....	26
2.2	[Module].....	27
2.2.1	Module Name .....	27
2.3	[Server x].....	28
2.3.1	Enabled .....	28
2.3.2	Service Port Number .....	28
2.3.3	Connection Timeout .....	28
2.3.4	Connection Close Type .....	28
2.3.5	Swap Rx Data Bytes .....	28
2.3.6	Swap Tx Data Bytes .....	29
2.4	Ethernet Configuration .....	30
2.5	Downloading the Project to the Module Using a Serial COM port .....	31

### **3 Ladder Logic** **33**

3.1	Module Data .....	34
3.1.1	GECInStat (Status Object) .....	37
3.1.2	GECServerStat (Server Status Object).....	38
3.1.3	GECBlkStat (Block Error Status Object) .....	38
3.1.4	GECClientStat .....	39
3.1.5	GECBackplane (Backplane Object) .....	40

---

3.2	Adding the Module to an Existing CompactLogix Project.....	41
3.3	Adding the Module to an Existing MicroLogix Project .....	43
<b>4</b>	<b>Diagnostics and Troubleshooting</b>	<b>45</b>
4.1	LED Status Indicators .....	46
4.1.1	Ethernet LED Indicators.....	46
4.1.2	Clearing a Fault Condition .....	47
4.1.3	Troubleshooting .....	48
4.2	Using ProSoft Configuration Builder (PCB) for Diagnostics .....	49
4.2.1	Using the Diagnostic Window in ProSoft Configuration Builder .....	49
4.2.2	Navigation .....	51
4.2.3	Main Menu .....	52
4.2.4	Network Menu.....	55
4.3	Reading Status Data from the Module .....	57
<b>5</b>	<b>Reference</b>	<b>59</b>
5.1	Product Specifications .....	60
5.1.1	General Specifications.....	60
5.1.2	Hardware Specifications .....	61
5.1.3	Functional Specifications - MVI69-GEC .....	62
5.2	Functional Overview .....	63
5.2.1	General Concepts.....	63
5.3	Cable Connections .....	78
5.3.1	Ethernet Connection .....	78
5.3.2	RS-232 Configuration/Debug Port .....	79
5.3.3	DB9 to RJ45 Adaptor (Cable 14) .....	82
5.4	MVI69-GEC Status Data For Block Transfer.....	83
<b>6</b>	<b>Support, Service &amp; Warranty</b>	<b>91</b>
	Contacting Technical Support .....	91
6.1	Return Material Authorization (RMA) Policies and Conditions .....	93
6.1.1	Returning Any Product.....	93
6.1.2	Returning Units Under Warranty.....	94
6.1.3	Returning Units Out of Warranty.....	94
6.2	LIMITED WARRANTY .....	95
6.2.1	What Is Covered By This Warranty .....	95
6.2.2	What Is Not Covered By This Warranty.....	96
6.2.3	Disclaimer Regarding High Risk Activities.....	96
6.2.4	Intellectual Property Indemnity .....	97
6.2.5	Disclaimer of all Other Warranties .....	97
6.2.6	Limitation of Remedies ** .....	98
6.2.7	Time Limit for Bringing Suit.....	98
6.2.8	No Other Warranties .....	98
6.2.9	Allocation of Risks .....	98
6.2.10	Controlling Law and Severability .....	99
	<b>Index</b>	<b>101</b>

---

## Guide to the MVI69-GEC User Manual

Function		Section to Read	Details
Introduction (Must Do)	→	Start Here (page 9)	This section introduces the customer to the module. Included are: package contents, system requirements, hardware installation, and basic configuration.
Diagnostic and Troubleshooting	→	Diagnostics and Troubleshooting (page 45)	This section describes Diagnostic and Troubleshooting procedures.
Reference  Product Specifications  Functional Overview	→	Reference (page 59)  Product Specifications (page 60)  Functional Overview (page 63)	These sections contain general references associated with this product, Specifications, and the Functional Overview.
Support, Service, and Warranty  Index	→	Support, Service and Warranty (page 91)  Index	This section contains Support, Service and Warranty information.  Index of chapters.



# 1 Start Here

## *In This Chapter*

❖ System Requirements .....	10
❖ Package Contents .....	11
❖ Installing ProSoft Configuration Builder Software .....	12
❖ Setting Jumpers .....	13
❖ Installing the Module in the Rack.....	14
❖ Connecting Your PC to the Processor.....	17
❖ Downloading the Sample Program to the Processor .....	18
❖ Connecting Your PC to the Module .....	21

To get the most benefit from this User Manual, you should have the following skills:

- **Rockwell Automation® RSLogix™ software:** launch the program, configure ladder logic, and transfer the ladder logic to the processor
- **Microsoft Windows:** install and launch programs, execute menu commands, navigate dialog boxes, and enter data
- **Hardware installation and wiring:** install the module, and safely connect GEC and CompactLogix or MicroLogix devices to a power source and to the MVI69-GEC module's application port(s)

## 1.1 System Requirements

The MVI69-GEC module requires the following minimum hardware and software components:

- *Rockwell Automation CompactLogix* or *MicroLogix* processor, with compatible power supply and one free slot in the rack, for the MVI69-GEC module. The module requires 800 mA of available power.

**Important:** The MVI69-GEC module has a power supply distance rating of 2 (L43 and L45 installations on first 2 slots of 1769 bus).

**Important:** For 1769-L23x processors, please make note of the following limitations.

- 1769-L23-QBFC1B = 800 mA at 5 Vdc (One MVI69-GEC will use all 800 mA of available power. No other modules can be used with an MVI69 module connected to this processor.)
- 1769-L23E-QB1B = 1000 mA at 5 Vdc (One MVI69-GEC will use 800 mA of available power. One other module can be used on this rack provided it consumes less than 200 mA at 5 Vdc.)
- 1769-L23E-QBFC1B = 450 mA at 5 Vdc (No MVI69 module can be used with this processor.)

- *Rockwell Automation RSLogix 5000 (CompactLogix)* or *RSLogix 500 (MicroLogix)* programming software
- *Rockwell Automation RSLinx* communication software
- *Pentium® II* 450 MHz minimum. *Pentium III* 733 MHz (or better) recommended
- Supported operating systems:
  - *Microsoft Windows XP Professional* with *Service Pack 1* or *2*
  - *Microsoft Windows 2000 Professional* with *Service Pack 1, 2, or 3*
  - *Microsoft Windows Server 2003*
- 128 Mbytes of RAM minimum, 256 Mbytes of RAM recommended
- 100 Mbytes of free hard disk space (or more based on application requirements)
- 256-color VGA graphics adapter, 800 x 600 minimum resolution (True Color 1024 × 768 recommended)
- CD-ROM drive
- HyperTerminal or other terminal emulator program capable of file transfers using Ymodem protocol.

## 1.2 Package Contents

The following components are included with your MVI69-GEC module, and are all required for installation and configuration.

**Important:** Before beginning the installation, please verify that all of the following items are present.

Qty.	Part Name	Part Number	Part Description
1	MVI69-GEC Module	MVI69-GEC	Generic ASCII Ethernet Communication Module
1	Cable	Cable #15 - RS232 Null Modem	For RS232 between a Personal Computer (PC) and the CFG port of the module
1	Cable	Cable #14 - RJ45 to DB9 Male Adapter	For connecting the module's port to Cable #15 for RS-232 connections
1	inRAX Solutions CD		Contains sample programs, utilities and documentation for the MVI69-GEC module.

If any of these components are missing, please contact ProSoft Technology Support for replacement parts.

### 1.3 Installing ProSoft Configuration Builder Software

You must install the *ProSoft Configuration Builder (PCB)* software to configure the module. You can always get the newest version of *ProSoft Configuration Builder* from the ProSoft Technology website.

#### **Installing ProSoft Configuration Builder from the ProSoft website**

- 1 Open your web browser and navigate to <http://www.prosoft-technology.com/pcb>
- 2 Click the **DOWNLOAD HERE** link to download the latest version of *ProSoft Configuration Builder*.
- 3 Choose **SAVE** or **SAVE FILE** when prompted.
- 4 Save the file to your *Windows Desktop*, so that you can find it easily when you have finished downloading.
- 5 When the download is complete, locate and open the file, and then follow the instructions on your screen to install the program.

If you do not have access to the Internet, you can install *ProSoft Configuration Builder* from the *ProSoft Solutions Product CD-ROM*, included in the package with your module.

#### **Installing ProSoft Configuration Builder from the Product CD-ROM**

- 1 Insert the *ProSoft Solutions Product CD-ROM* into the CD-ROM drive of your PC. Wait for the startup screen to appear.
- 2 On the startup screen, click **PRODUCT DOCUMENTATION**. This action opens a *Windows Explorer* file tree window.
- 3 Click to open the **UTILITIES** folder. This folder contains all of the applications and files you will need to set up and configure your module.
- 4 Double-click the **SETUP CONFIGURATION TOOL** folder, double-click the **PCB\_\*.EXE** file and follow the instructions on your screen to install the software on your PC. The information represented by the "\*" character in the file name is the *PCB* version number and, therefore, subject to change as new versions of *PCB* are released.

**Note:** Many of the configuration and maintenance procedures use files and other utilities on the CD-ROM. You may wish to copy the files from the Utilities folder on the CD-ROM to a convenient location on your hard drive.

## 1.4 Setting Jumpers

The Setup Jumper acts as "write protection" for the module's flash memory. In "write protected" mode, the Setup pins are not connected, and the module's firmware cannot be overwritten. Do not jumper the Setup pins together unless you are directed to do so by ProSoft Technical Support.

The following illustration shows the MVI69-GEC jumper configuration.

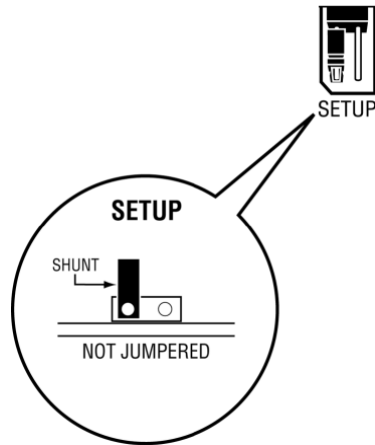

**Note:** If you are installing the module in a remote rack, you may prefer to leave the Setup pins jumpered. That way, you can update the module's firmware without requiring physical access to the module.

## 1.5 Installing the Module in the Rack

This section describes how to install the module into a CompactLogix or MicroLogix rack.

Before you attempt to install the module, make sure that the bus lever of the adjacent module is in the unlocked (fully right) position.

**Warning: This module is not hot-swappable!** Always remove power from the rack before inserting or removing this module, or damage may result to the module, the processor, or other connected devices.

- 1 Align the module using the upper and lower tongue-and-groove slots with the adjacent module and slide forward in the direction of the arrow.

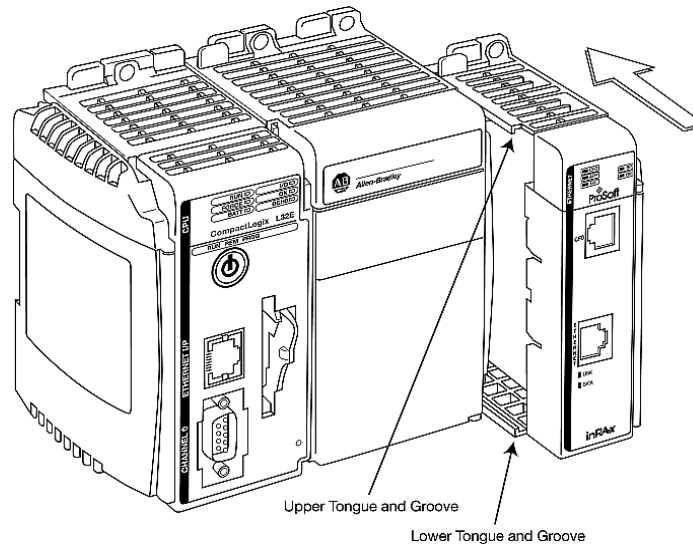

- 2 Move the module back along the tongue-and-groove slots until the bus connectors on the MVI69 module and the adjacent module line up with each other.

- 3 Push the module's bus lever back slightly to clear the positioning tab and move it firmly to the left until it clicks. Ensure that it is locked firmly in place.

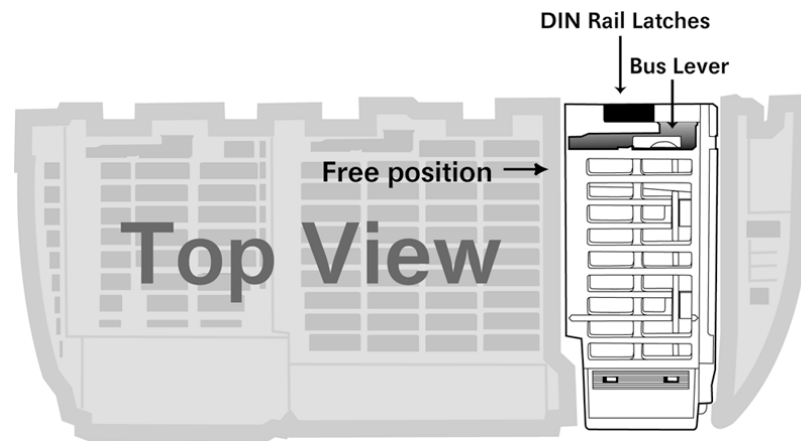

Move the Bus Lever to the left  
until it clicks

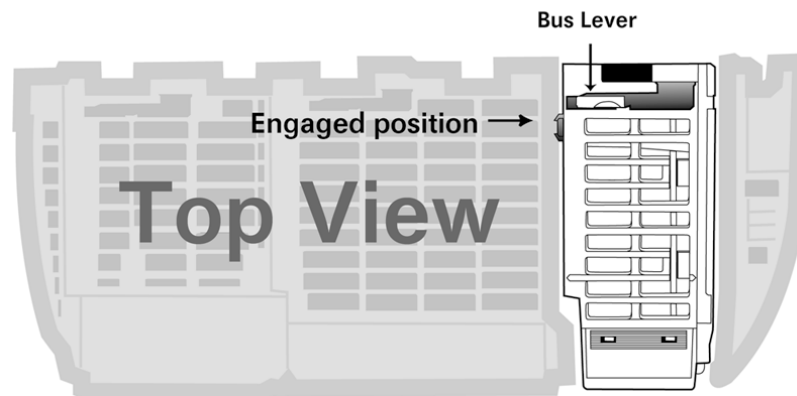

- 4 Close all DIN-rail latches.

- 5 Press the DIN-rail mounting area of the controller against the DIN-rail. The latches will momentarily open and lock into place.

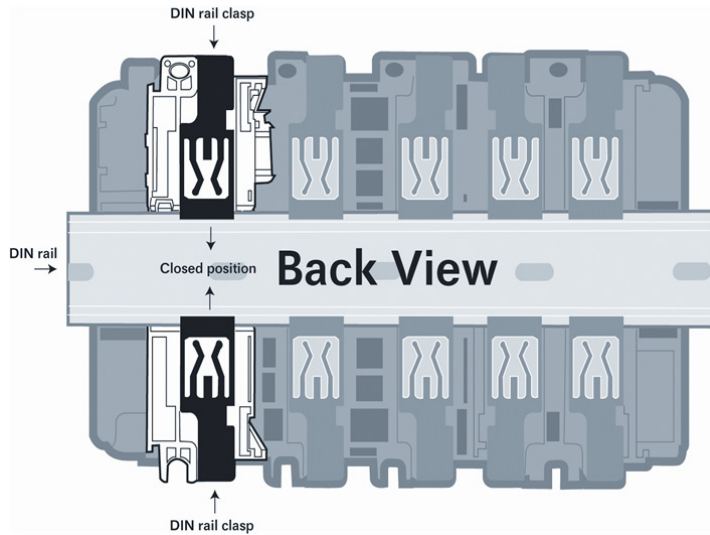
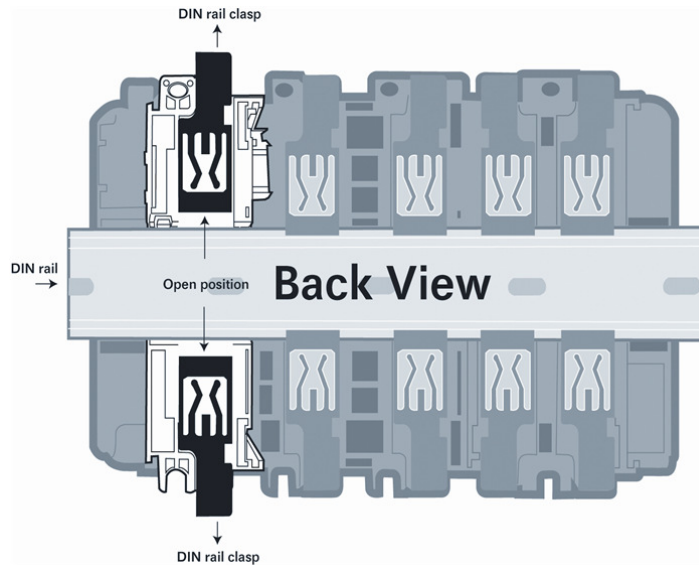

## 1.6 Connecting Your PC to the Processor

- 1 Connect the right-angle connector end of the cable to your controller at the communications port.

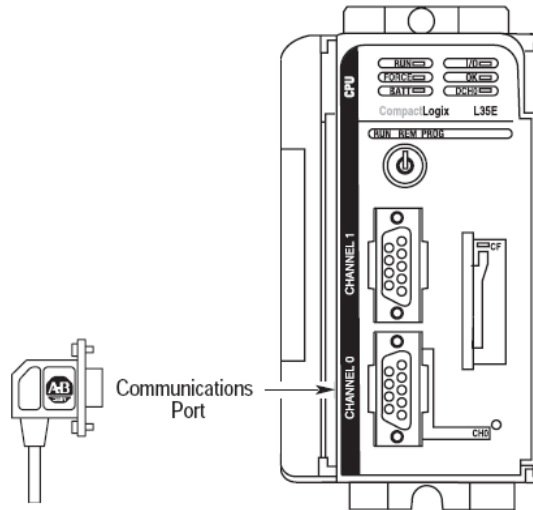

- 2 Connect the straight connector end of the cable to the serial port on your computer.

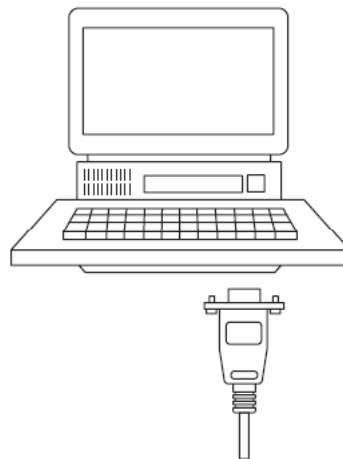

## 1.7 Downloading the Sample Program to the Processor

**Note:** The key switch on the front of the *CompactLogix* processor must be in the REM or PROG position.

- 1 If you are not already online to the processor, open the **COMMUNICATIONS** menu, and then choose **DOWNLOAD**. *RSLogix* will establish communication with the processor.
- 2 When communication is established, *RSLogix* will open a confirmation dialog box. Click the **DOWNLOAD** button to transfer the sample program to the processor.

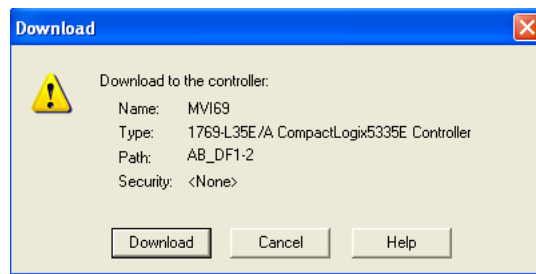

- 3 *RSLogix* will compile the program and transfer it to the processor. This process may take a few minutes.
- 4 When the download is complete, *RSLogix* will open another confirmation dialog box. Click **OK** to switch the processor from PROGRAM mode to RUN mode.

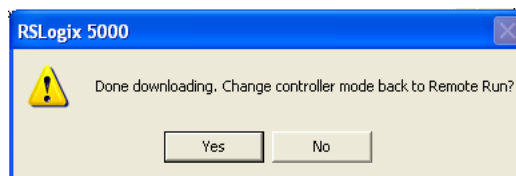

**Note:** If you receive an error message during these steps, refer to your *RSLogix* documentation to interpret and correct the error.

### 1.7.1 Configuring the RSLinx Driver for the PC COM Port

If RSLogix is unable to establish communication with the processor, follow these steps.

- 1 Open *RSLogix*.
- 2 Open the **COMMUNICATIONS** menu, and choose **CONFIGURE DRIVERS**.

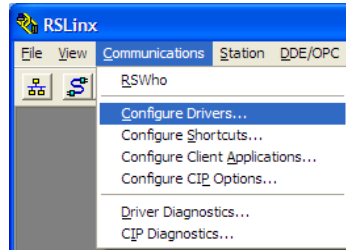

This action opens the *Configure Drivers* dialog box.

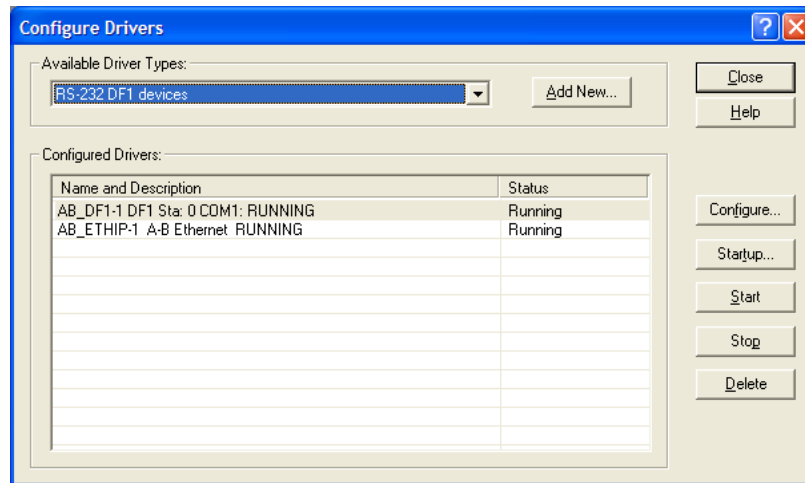

**Note:** If the list of configured drivers is blank, you must first choose and configure a driver from the Available Driver Types list. The recommended driver type to choose for serial communication with the processor is *RS-232 DF1 Devices*.

- 1 Click to select the driver, and then click **CONFIGURE**. This action opens the *Configure RS-232 DF1 Devices* dialog box.

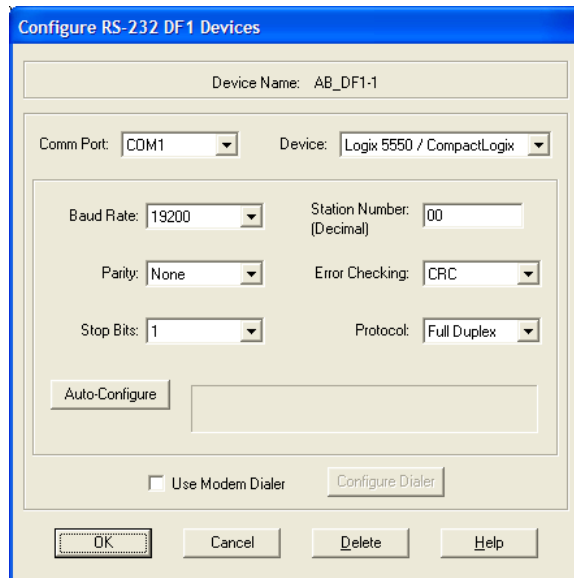

- 2 Click the **AUTO-CONFIGURE** button. *RSLinx* will attempt to configure your serial port to work with the selected driver.
- 3 When you see the message *Auto Configuration Successful*, click the **OK** button to dismiss the dialog box.

**Note:** If the auto-configuration procedure fails, verify that the cables are connected correctly between the processor and the serial port on your computer, and then try again. If you are still unable to auto-configure the port, refer to your *RSLinx* documentation for further troubleshooting steps.

## 1.8 Connecting Your PC to the Module

With the module securely mounted, connect your PC to the CFG (Configuration/Debug) port using an RJ45-DB-9 Serial Adapter Cable and a Null Modem Cable.

- 1 Attach both cables as shown.
- 2 Insert the RJ45 cable connector into the CFG port of the module.
- 3 Attach the other end to the serial port on your PC.

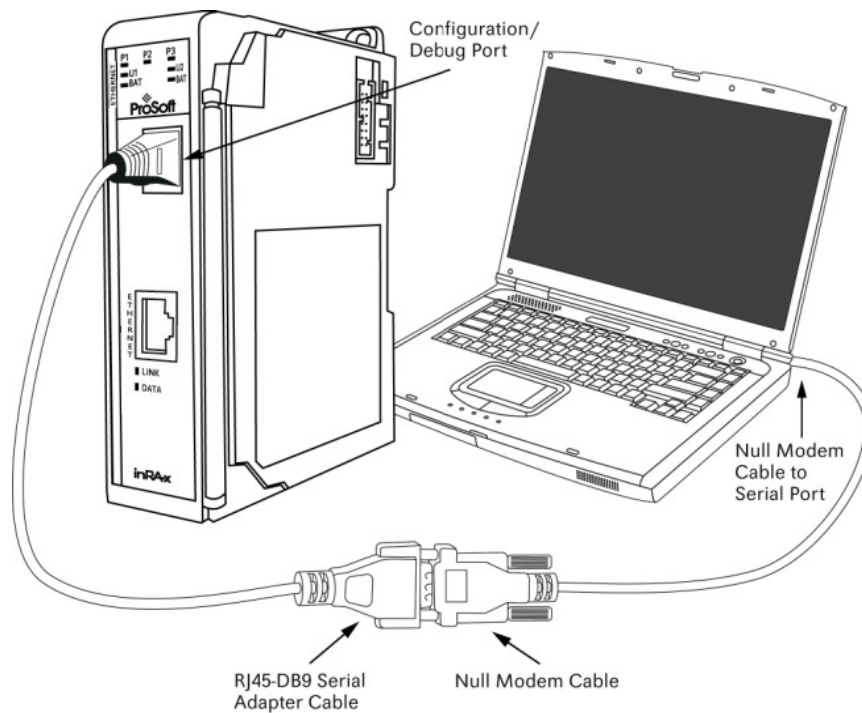



## 2 Configuring the MVI69-GEC Module

### *In This Chapter*

- ❖ Using ProSoft Configuration Builder ..... 24
- ❖ [Module]..... 27
- ❖ [Server x] ..... 28
- ❖ Ethernet Configuration ..... 30
- ❖ Downloading the Project to the Module Using a Serial COM port ..... 31

## 2.1 Using ProSoft Configuration Builder

*ProSoft Configuration Builder (PCB)* provides a quick and easy way to manage module configuration files customized to meet your application needs. *PCB* is not only a powerful solution for new configuration files, but also allows you to import information from previously installed (known working) configurations to new projects.

### 2.1.1 Setting Up the Project

To begin, start *ProSoft Configuration Builder*. If you have used other *Windows* configuration tools before, you will find the screen layout familiar. *ProSoft Configuration Builder's* window consists of a tree view on the left, an information pane and a configuration pane on the right side of the window. When you first start *ProSoft Configuration Builder*, the tree view consists of folders for *Default Project* and *Default Location*, with a *Default Module* in the *Default Location* folder. The following illustration shows the *ProSoft Configuration Builder* window with a new project.

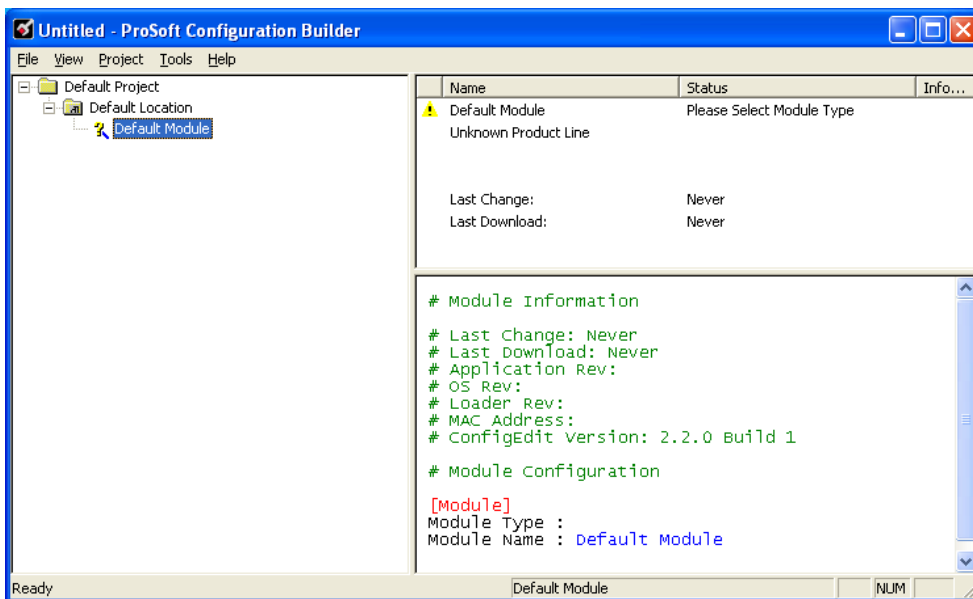

Your first task is to add the MVI69-GEC module to the project.

- 1 Use the mouse to select **DEFAULT MODULE** in the tree view, and then click the right mouse button to open a shortcut menu.

- 2 On the shortcut menu, select **CHOOSE MODULE TYPE**. This action opens the *Choose Module Type* dialog box.

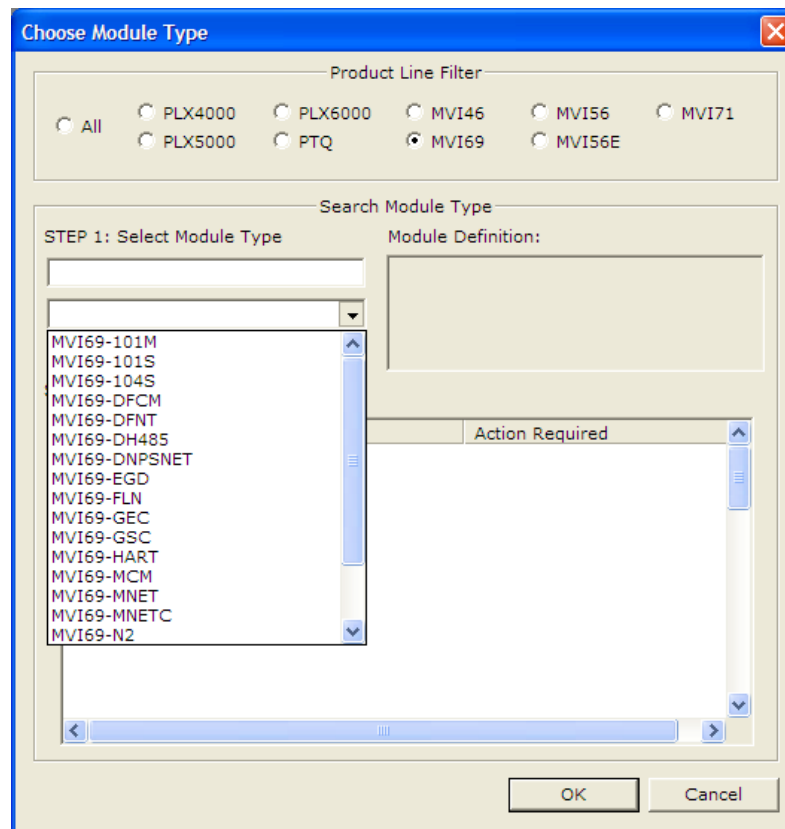

- 3 In the *Product Line Filter* area of the dialog box, select **MVI69**. In the *Select Module Type* dropdown list, select **MVI69-GEC**, and then click **OK** to save your settings and return to the *ProSoft Configuration Builder* window.

### 2.1.2 Renaming PCB Objects

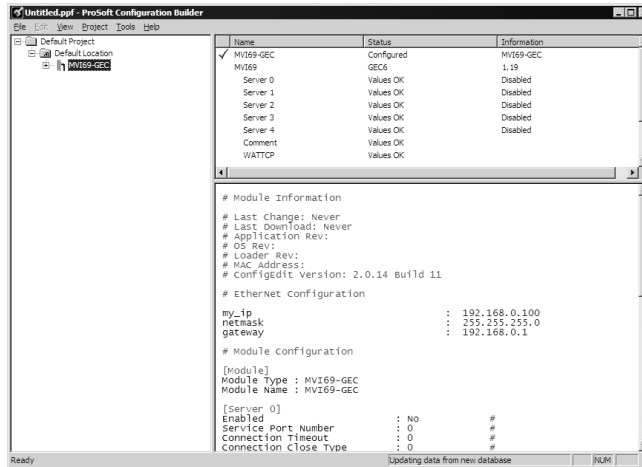

Notice that the contents of the information pane and the configuration pane changed when you added the module to the project.



At this time, you may wish to rename the *Default Project* and *Default Location* folders in the tree view.

- 1 Select the object, and then click the right mouse button to open a shortcut menu. From the shortcut menu, choose **RENAME**.
- 2 Type the name to assign to the object.
- 3 Click *away* from the object to save the new name.

#### Configuring Module Parameters

- 1 Click on the **[+]** sign next to the module icon to expand module information.
- 2 Click on the **[+]** sign next to any  icon to view module information and configuration options.
- 3 Double-click any  icon to open an *Edit* dialog box.
- 4 To edit a parameter, select the parameter in the left pane and make your changes in the right pane.
- 5 Click **OK** to save your changes.

#### Printing a Configuration File

- 1 Select the module icon, and then click the right mouse button to open a shortcut menu.
- 2 On the shortcut menu, choose **VIEW CONFIGURATION**. This action opens the *View Configuration* window.
- 3 In the *View Configuration* window, open the **FILE** menu, and choose **PRINT**. This action opens the *Print* dialog box.
- 4 In the *Print* dialog box, choose the printer to use from the drop-down list, select printing options, and then click **OK**.

## 2.2 [Module]

This section of the file describes the database setup and module level parameters.

[Module]

Module Name: MVI69-GEC Communication Module DEFAULT

### 2.2.1 *Module Name*

**0** to **80** characters

This parameter assigns a name to the module that can be viewed using the configuration/debug port. Use this parameter to identify the module and the configuration file.

## 2.3 [Server x]

You can configure up to five servers ([Server 0] through [Server 4]). The configuration section for each server contains the same set of parameters. You can configure the parameters for each server to meet the requirements of your application.

### **2.3.1 Enabled**

Yes or No

This parameter determines if the server will be utilized by the module. If a value of "Yes" is entered, the server will be used. Any other value will disable the server.

### **2.3.2 Service Port Number**

1 to 65535

This parameter sets the TCP/IP service port for this server. Each server can have its own unique service port or can share the same number with other servers.

### **2.3.3 Connection Timeout**

0 or 5000 to 65535

This parameter specifies the number of milliseconds the server will permit the server to be inactive after a connection is made before closing the socket. This timeout period is reset on each read or write packet. If the parameter is set to 0, the connection will not timeout.

### **2.3.4 Connection Close Type**

0, 1 or 2

This coded parameter defines the personality of the server after a connection is made. If the parameter is set to 0, the socket will only be closed when a request from the client is received or the connection timeout is exceeded. If a value of 1 is selected, the server will close the socket after it transmits a single message. If a value of 2 is selected, the server will close the socket after it receives a message.

### **2.3.5 Swap Rx Data Bytes**

Yes or No

This parameter determines if the data received by the server will have the byte order of the data swapped. If the parameter is set to No, no byte swapping will occur. If the parameter is set to Yes, the odd byte will be swapped with the even byte in each word of data received.

### **2.3.6 Swap Tx Data Bytes**

Yes or No

This parameter determines if the data to be transmitted by the module will have the byte order of the data swapped. If the parameter is set to No, no byte swapping will occur. If the parameter is set to Yes, the odd byte will be swapped with the even byte in each word of data received.

## 2.4 Ethernet Configuration

Use this procedure to configure the Ethernet settings for your module. You must assign an IP address, subnet mask and gateway address. After you complete this step, you can connect to the module with an Ethernet cable.

- 1 Determine the network settings for your module, with the help of your network administrator if necessary. You will need the following information:
  - IP address (fixed IP required) \_\_\_\_\_ . \_\_\_\_\_ . \_\_\_\_\_ . \_\_\_\_\_
  - Subnet mask \_\_\_\_\_ . \_\_\_\_\_ . \_\_\_\_\_ . \_\_\_\_\_
  - Gateway address \_\_\_\_\_ . \_\_\_\_\_ . \_\_\_\_\_ . \_\_\_\_\_

**Note:** The gateway address is optional, and is not required for networks that do not use a default gateway.

- 2 Double-click the **ETHERNET CONFIGURATION** icon. This action opens the *Edit* dialog box.

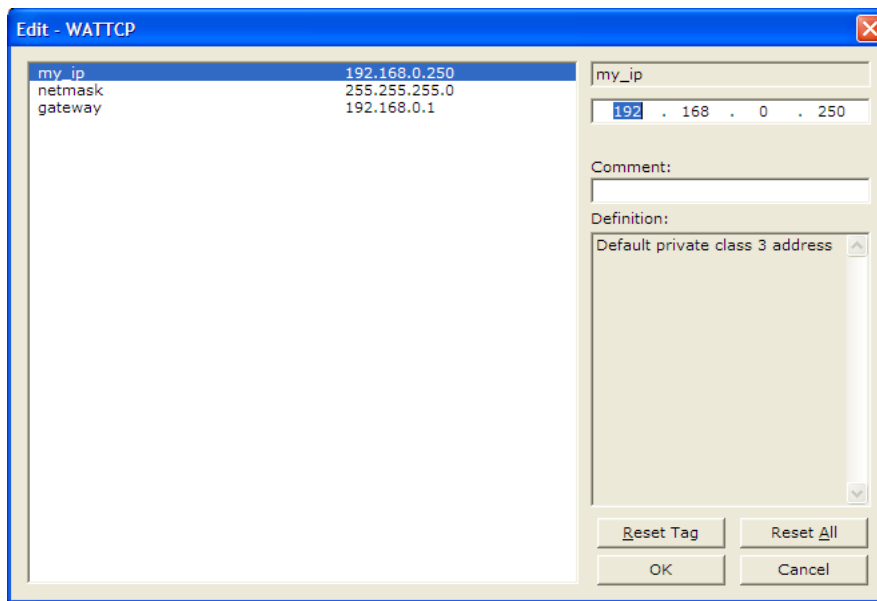

- 3 Edit the values for *my\_ip*, *netmask* (subnet mask) and *gateway* (default gateway).
- 4 When you are finished editing, click **OK** to save your changes and return to the *ProSoft Configuration Builder* window.

## 2.5 Downloading the Project to the Module Using a Serial COM port

For the module to use the settings you configured, you must download (copy) the updated *Project* file from your PC to the module.

- 1 In the tree view in *ProSoft Configuration Builder*, click once to select the module.
- 2 Open the *Project* menu, and then choose **MODULE/DOWNLOAD**. The program will scan your PC for a valid com port (this may take a few seconds). When *PCB* has found a valid COM port, the *Download* dialog box will open.

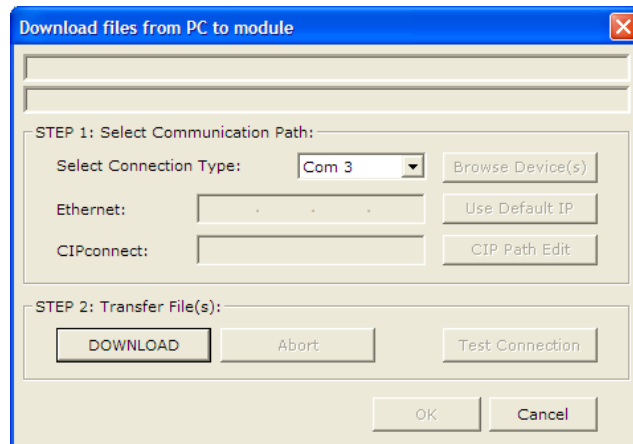

- 3 Choose the COM port to use from the dropdown list, and then click the **DOWNLOAD** button.

The module will perform a platform check to read and load its new settings. When the platform check is complete, the status bar in the *Download* dialog box will display the message *Module Running*.

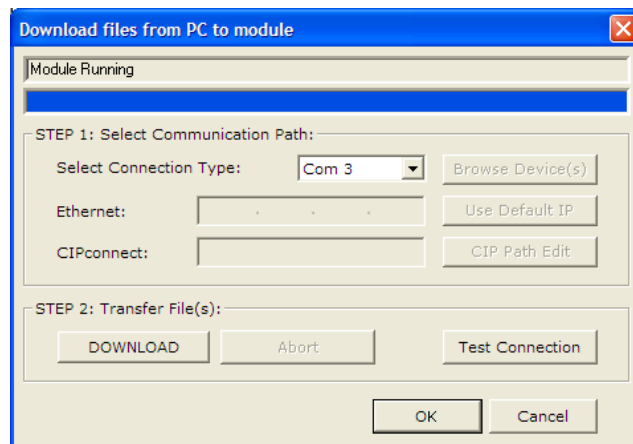



## 3 Ladder Logic

### In This Chapter

- ❖ Module Data ..... 34
- ❖ Adding the Module to an Existing CompactLogix Project ..... 41
- ❖ Adding the Module to an Existing MicroLogix Project..... 43

Ladder logic is required for application of the MVI69-GEC module. Tasks that must be handled by the ladder logic are module data transfer, special block handling, and status data receipt. Additionally, a power-up handler may be needed to handle the initialization of the module's data and to clear any processor fault conditions.

The sample ladder logic, on the *ProSoft Solutions CD-ROM*, is extensively commented, to provide information on the purpose and function of each rung. For most applications, the sample ladder will work without modification.

### 3.1 Module Data

All data related to the MVI69-GEC is stored in a user defined data type.  
The following Table depicts the Object Hierarchy of the Tags used along with Data Type of the Tags.

OBJECT HIERARCHY		DATA TYPE
Stat		GECInStat
	PassCnt	INT
	Product	INT[2]
	Rev	INT[2]
	OP	INT[2]
	Run	INT[2]
	BlkErrs	GECBlkStat
	Read	INT
	Write	INT
	Parse	INT
	Err	INT
Server		GECServerStat[5]
	Enabled	INT
	State	INT
	IP	INT[2]
	Port	INT
	Open	INT
	Est	INT
	Close	INT
	Rx	INT
	RxOverflow	INT
	Tx	INT
	TxOverflow	INT
	Timeout	INT
	CfgErrword	INT
Client		GECClientStat[5]
	Connected	INT
	State	INT
	IP	DINT
	Port	INT
	RxCount	INT
	RxOverflow	INT
	TxCount	INT

OBJECT HIERARCHY		DATA TYPE
	TxOverflow	INT
	Spare	INT
Backplane		GECBackplane
	LastRead	INT
	LastWriteCount	INT
	CurBlock	INT
	UnitNumber	INT
	RxLen	INT
	TxServer	INT
	TxCount	INT
Clients		GEClientSet[5]
	ConnectionSetup	GECClientConnection
	Client	INT
	Spare1	INT
	ServerIP	INT[4]
	ServicePort	INT
	SwapRx	INT
	SwapTx	INT
	TimeOut	INT
	ReadData	SINT[4000]
	ReadDataCount	INT
	ReadTotalCount	INT
	WriteData	SINT[4000]
	WriteDataCount	INT
	WriteTotalCount	INT
	Flags	GECClientFlags
	Connect	BOOL
	CloseConnection	BOOL
	WriteData	BOOL
	Util	GECClientUtil
	LastTxCount	INT
	LastRxCount	INT
	ReadingBlocks	BOOL
	ReadIndex	INT
	WritingBlocks	BOOL
	WriteIndex	INT

OBJECT HIERARCHY		DATA TYPE
	WriteData	BOOL
	WriteCount	INT
	LastWriteCount	INT
Servers		GECServerSet[5]
	ReadData	SINT[4000]
	ReadDataCount	INT
	ReadTotalCount	INT
	WriteData	SINT[4000]
	WriteDataCount	INT
	WriteTotalCount	INT
Flags		GECServerFlags
	InitiateWriteData	BOOL
	CloseConnection	BOOL
Util		GECServerUtil
	ReadingBlocks	BOOL
	ReadIndex	INT
	WritingBlocks	BOOL
	WriteIndex	INT
	WriteData	BOOL
	WriteCount	INT
	LastWriteCount	INT
Flags		GECFlags
	Cfg	BOOL
	Coldboot	BOOL
	Warmboot	BOOL
Util		GECModuleUtil
	CommTimer	TIMER[5]
	ReadIndex	INT
	WriteIndex	INT

An instance of the data type is required before the module can be used.

This is done by declaring a variable of the data type in the Controller Tags Edit Tags dialog box. The following table describes the structure of the object.

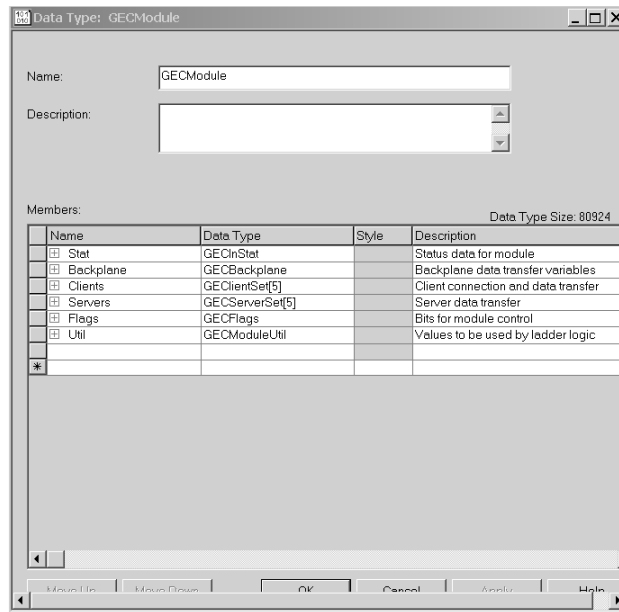

This object contains objects that define variables for the module and status data related to the module. Each of these object types is discussed in the following topics of the document.

### 3.1.1 GECInStat (Status Object)

This object views the status of the module. The **GECInStat** object shown below is updated each time a read block is received by the processor. Use this data to monitor the state of the module at a "real-time rate".

Name	Data Type	Description
PassCnt	INT	Program cycle counter for module
Product	INT[2]	Product code for module (GEC)
Rev	INT[2]	Revision level of module's code
OP	INT[2]	Operating system version for module
Run	INT[2]	Run number for module
BlkErrs	GECBlkStat	Data block transfer statistics
Server	GECServerStat[5]	Status for each server
Client	GECClientStat[5]	Status for each client

Within the GECInStat objects are objects containing the status information for each server and the block transfer process. Refer to the Reference chapter for a complete listing of the data stored in this object.

### 3.1.2 GECServerStat (Server Status Object)

The GECServerStat object stores the status information related to each individual server on the module. All messages are counted for both the receive and transmit operations. Additionally, the object contains the CfgErrword member. This member is discussed in the following section. The following table describes the structure of the object.

Name	Data Type	Description
Enabled	INT	Flag to indicate if server is enabled (1=Yes,0=No)
State	INT	Current state of server
IP	INT[4]	IP address of host connected to server
Port	INT	TCP port for host connected to server
Open	INT	Number of times server performed an open
Est	INT	Number of times connection established
Close	INT	Number of times socket closed
Rx	INT	Number of messages received
RxOverflow	INT	Number of receive buffer overflows
Tx	INT	Number of messages transmitted
TxOverflow	INT	Number of transmit buffer overflows
Timeout	INT	Number of socket timeout conditions
CfgErrword	INT	Configuration error word value for server

### 3.1.3 GECBlkStat (Block Error Status Object)

The GECBlkStat object holds the status data related to the data transfer between the module and the controller. Each read and write block transferred between the module and the controller is counted in the Read and Write data members, respectively. Each write block that is parse by the module is counted in the Parse data member. The Err member is incremented each time a bad block is transferred between the two devices or there is an error in the backplane driver in the module. The following table describes the structure of the object.

Name	Data Type	Description
Read	INT	Number of blocks read by the module
Write	INT	Number of blocks written by the module
Parse	INT	Number of blocks parsed by the module
Err	INT	Number of block transfer errors

### 3.1.4 GECClientStat

This object stores the status information for a single client in the module. This data is received from the module in each new input image. The following table describes the structure of the object.

Name	Data Type	Description
Connected	INT	Connection state
State	INT	Socket state
IP	DINT	IP address of connected server
Port	INT	Service port of connected server
RxCount	INT	Number of receive messages
RxOverflow	INT	Number of times receive buffer overflowed
TxCount	INT	Number of transmit messages
TxOverflow	INT	Number of times the transmit buffer overflowed

The connected member of the object can have one of the values shown in the following table.

State Value	Definition
-3	Server closed connection for client or server is not available.
-2	Unable to open connection with specified server.
-1	Unable to open connection with specified server because of invalid IP address.
0	The client is idle and not connected.
1	The client set to connect to the server and waiting for the connection to establish.
2	The client is connected to the server and can transfer data.
3	The connection is being closed for the client.

A value less than one indicates that the client is not connected to a server and is available for use. If the client was previously used and an error condition existed relative to the socket, this parameter will be set to a value less than zero. If the client socket closed normally, the value will be set to 0.

When the ladder logic requests a new connection, it will set the parameter to a value of 1. The module will recognize this request and initiate the connection with the specified server. If the connection is established, the parameter will be set to two. Data may now be exchanged between the client and the server.

The parameter will be set to a value of 3 when the connection is being closed. This operation can be initiated from either the client using the Client control word in the output image or by the server.

The state member of the object can have one of the following values:

State Value	Definition
-1	Client is waiting for a connection request.
0	The client is waiting to establish the connection with the server.
1	The client has established a connection with the server and can send and receive data.
1000	The client has initiated a close operation on the connection.
1001	The client is waiting for the close on the connection to complete.
1002	The client is issuing an abort (reset) on the connection. The socket is forced closed.
3000	The client is issuing the ARP command request and waiting for the response.
3001	The client has received the ARP response and has opened the socket.

This member reports the current state of the client socket state machine in the module. It is preferred to use the Connected member of the object in the ladder logic instead of this member for control.

The next two members of the object are set by the ladder logic and correspond to the IP address of the server connected to the client and the service port in the server used for the connection.

The last four members of the object are statistics representing the transmit and receive activity of the client socket.

### 3.1.5 GECBackplane (Backplane Object)

The GECBackplane object stores all the variables required for the data transfer operation between the module and the controller. The LastRead data member is used as the handshaking byte to indicate the arrival of new data from the module. The following table describes the structure of the object.

Name	Data Type	Description
LastRead	INT	Sequence number of last block read
LastWriteCount	SINT[2]	Last number of bytes written
CurBlock	INT	Sequence number for current block
SourceIndex	INT	Current server or client in read block
RxLen	INT	Length of message received
TxServer	INT	Server number for current transmit
TxCount	INT	Number of bytes processed from last tx message

The other members of the object can be utilized in the ladder logic to assist in the data transfer operation.

### 3.2 Adding the Module to an Existing CompactLogix Project

**Important:** The MVI69-GEC module has a power supply distance rating of 2 (L43 and L45 installations on first 2 slots of 1769 bus)

If you are installing and configuring the module with a CompactLogix processor, follow these steps. If you are using a MicroLogix processor, refer to the next section (page 43).

- 1 Add the MVI69-GEC module to the project.** Right-click the mouse button on the I/O Configuration option in the Controller Organization window to display a pop-up menu. Select the New Module option from the I/O Configuration menu.

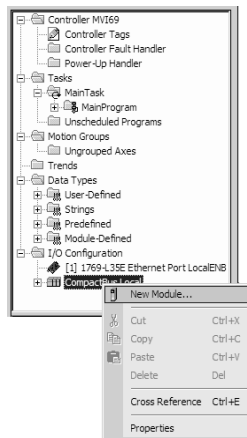

This action opens the following dialog box:

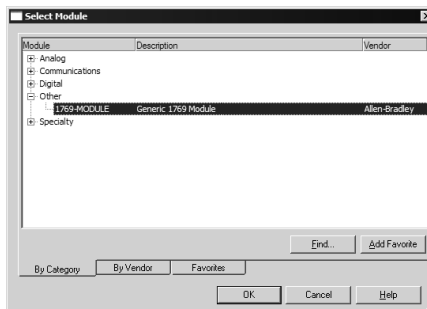

- 2 Select the 1769-Module (Generic 1769 Module) from the list and click OK.

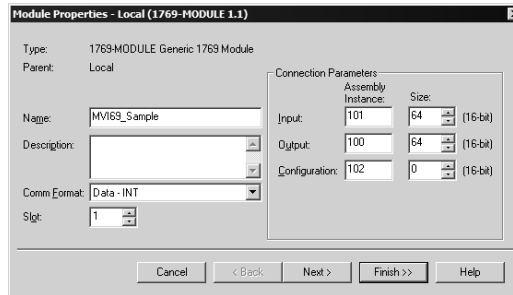

- 3 Enter the Name, Description and Slot options for your application, using the values in the illustration above. You must select the **Comm Format as Data - INT** in the dialog box, otherwise the module will not communicate over the backplane of the CompactLogix rack. Click **OK** to continue.

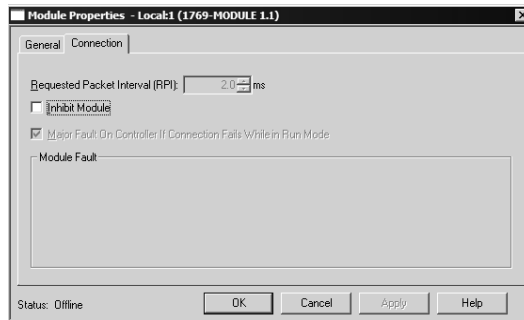

- 4 Select the Request Packet Interval value for scanning the I/O on the module. This value represents the minimum frequency the module will handle scheduled events. This value should not be set to less than 1 millisecond. Values between 1 and 10 milliseconds should work with most applications.
- 5 Save the module. Click OK to dismiss the dialog box. The Controller Organization window now displays the module's presence. The following illustration shows the Controller Organization window:

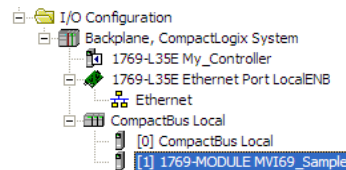

- 6 Copy the Controller Tags from the sample program.
- 7 Copy the User Defined Data Types from the sample program.
- 8 Copy the Ladder Rungs from the sample program.
- 9 Save and Download (page 18) the new application to the controller and place the processor in run mode.

### 3.3 Adding the Module to an Existing MicroLogix Project

If you are installing and configuring the module with a MicroLogix processor, follow these steps. If you are using a CompactLogix processor, refer to the previous section (page 41).

The first step in setting up the processor ladder file is to define the I/O type module to the system. Start RSLogix 500, and follow these steps:

- 1 In RSLogix, open your existing application, or start a new application, depending on your requirements.
- 2 Double-click the I/O Configuration icon located in the Controller folder in the project tree. This action opens the I/O Configuration dialog box.

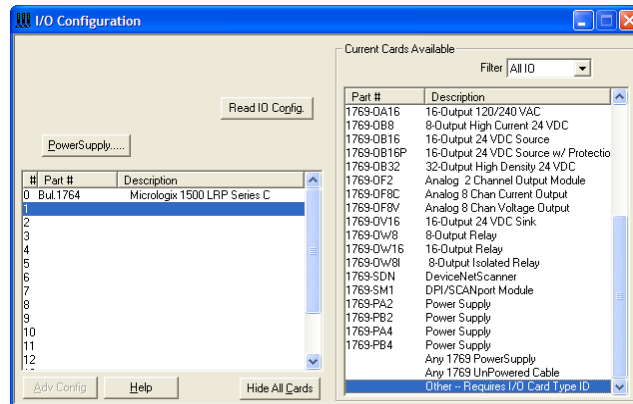

- 3 On the I/O Configuration dialog box, select "Other - Requires I/O Card Type ID" at the bottom of the list in the right pane, and then double-click to open the Module dialog box.
- 4 Enter the values shown in the following illustration to define the module correctly for the MicroLogix processor. Click OK to save your configuration.

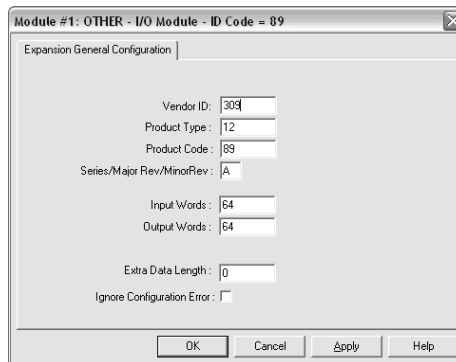

The input words and output words parameter will depend on the Block Transfer Size parameter you specify in the configuration file. Use the values from the following table.

Block Transfer Size	Input Words	Output Words
64	64	64

- 5 Click **Next** to continue.
- 6 After completing the module setup, the I/O configuration dialog box will display the module's presence.

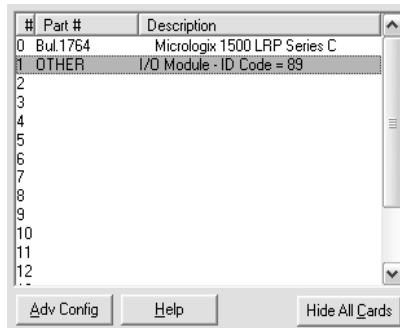

- 7 Copy the Ladder Rungs from the sample program.
- 8 Save and Download (page 18) the new application to the controller and place the processor in run mode.

The last step is to add the ladder logic. If you are using the example ladder logic, adjust the ladder to fit your application. Refer to the example Ladder Logic section in this manual.

Download the new application to the controller and place the processor in run mode. If you encounter errors, refer to **Diagnostics and Troubleshooting** (page 45) for information on how to connect to the module's Config/Debug port to use its troubleshooting features.

## 4 Diagnostics and Troubleshooting

### In This Chapter

❖ LED Status Indicators.....	46
❖ Using ProSoft Configuration Builder (PCB) for Diagnostics.....	49
❖ Reading Status Data from the Module .....	57

The module provides information on diagnostics and troubleshooting in the following forms:

- LED status indicators on the front of the module provide general information on the module's status.
- Status data contained in the module can be viewed through the Configuration/Debug port, using the troubleshooting and diagnostic capabilities of *ProSoft Configuration Builder (PCB)*.
- Status data values can be transferred from the module to processor memory and can be monitored there manually or by customer-created logic.

## 4.1 LED Status Indicators

The LEDs indicate the module's operating status as follows:

LED	Color	Status	Indication
CFG	Green	On	Data is being transferred between the module and a remote terminal using the Configuration/Debug port.
		Off	No data is being transferred on the Configuration/Debug port.
P1	Green	On	Data is being transferred between the module and the DH-485 network on Port 1.
		Off	No data is being transferred on the port.
P2	Green	On	Data is being transferred between the module and the DH-485 network on Port 2.
		Off	No data is being transferred on the port.
APP	Amber	On	The MVI69-DH485 module program has recognized a communication error on one of its ports.
		Off	The MVI69-DH485 is functioning normally.
BP ACT	Amber	On	The LED is on when the module is performing a write operation on the backplane.
		Off	The LED is off when the module is performing a read operation on the backplane. Under normal operation, the LED should blink rapidly on and off.
OK	Red/ Green	Off	The card is not receiving any power and is not securely plugged into the rack.
		Green	The module is operating normally.
		Red	The program has detected an error or is being configured. If the LED remains red for over 10 seconds, the program has probably halted. Remove the card from the rack and re-insert the card to restart the module's program.
BAT	Red	Off	The battery voltage is OK and functioning.
		On	The battery voltage is low or battery is not present. Allow battery to charge by keeping module plugged into rack for 24 hours. If BAT LED still does not go off, contact ProSoft Technology, as this is not a user serviceable item.

### 4.1.1 Ethernet LED Indicators

LED	State	Description
Data	OFF	No activity on the Ethernet port.
	GREEN Flash	The Ethernet port is actively transmitting or receiving data.
Link	OFF	No physical network connection is detected. No Ethernet communication is possible. Check wiring and cables.
	GREEN Solid	Physical network connection detected. This LED must be ON solid for Ethernet communication to be possible.

### **4.1.2 Clearing a Fault Condition**

Typically, if the OK LED on the front of the module turns RED for more than ten seconds, a hardware problem has been detected in the module or the program has exited.

To clear the condition, follow these steps:

- 1** Turn off power to the rack.
- 2** Remove the card from the rack.
- 3** Verify that all jumpers are set correctly.
- 4** If the module requires a Compact Flash card, verify that the card is installed correctly.
- 5** Re-insert the card in the rack and turn the power back on.
- 6** Verify correct configuration data is being transferred to the module from the CompactLogix or MicroLogix controller.

If the module's OK LED does not turn GREEN, verify that the module is inserted completely into the rack. If this does not cure the problem, contact ProSoft Technology Technical Support.

### 4.1.3 Troubleshooting

Use the following troubleshooting steps if you encounter problems when the module is powered up. If these steps do not resolve your problem, please contact ProSoft Technology Technical Support.

#### Processor Errors

Problem Description	Steps to take
Processor Fault	Verify that the module is plugged into the slot that has been configured for the module. Verify that the slot in the rack configuration has been set up correctly in the ladder logic.
Processor I/O LED flashes	This indicates a problem with backplane communications. Verify that all modules in the rack are configured in the ladder logic. Module has a power supply distance rating of 2 on Compact Logix. The module must be within 2 slots of the power supply on Compact Logix, or that the MicroLogix backplane can supply the 800ma required for the module.

#### Module Errors

Problem Description	Steps to take
BP ACT LED remains off or blinks slowly	This indicates that backplane transfer operations are failing. Connect to the module's Configuration/Debug port to check this. To establish backplane communications, verify the following items: <ul style="list-style-type: none"><li>▪ The processor is in Run mode</li><li>▪ The backplane driver is loaded in the module</li><li>▪ The module is configured for read and write block data transfer</li><li>▪ The ladder logic handles all read and write block situations</li><li>▪ The module is configured in the processor</li></ul>
OK LED remains red	The program has halted or a critical error has occurred. Connect to the Configuration/Debug port to see if the module is running. If the program has halted, turn off power to the rack, remove the card from the rack and re-insert the card in the rack, and then restore power to the rack.

## 4.2 Using ProSoft Configuration Builder (PCB) for Diagnostics

The *Configuration and Debug* menu for this module is arranged as a tree structure, with the *Main* menu at the top of the tree, and one or more submenus for each menu command. The first menu you see when you connect to the module is the *Main* menu.

Because this is a text-based menu system, you enter commands by typing the [command letter] from your computer keyboard in the *Diagnostic* window in *ProSoft Configuration Builder (PCB)*. The module does not respond to mouse movements or clicks. The command executes as soon as you press the **[COMMAND LETTER]** — you do not need to press **[ENTER]**. When you type a **[COMMAND LETTER]**, a new screen will be displayed in your terminal application.

### 4.2.1 Using the Diagnostic Window in ProSoft Configuration Builder

To connect to the module's Configuration/Debug serial port

- 1 Start *PCB*, and then select the module to test. Click the right mouse button to open a shortcut menu.

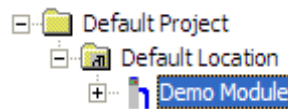

- 2 On the shortcut menu, choose **DIAGNOSTICS**.

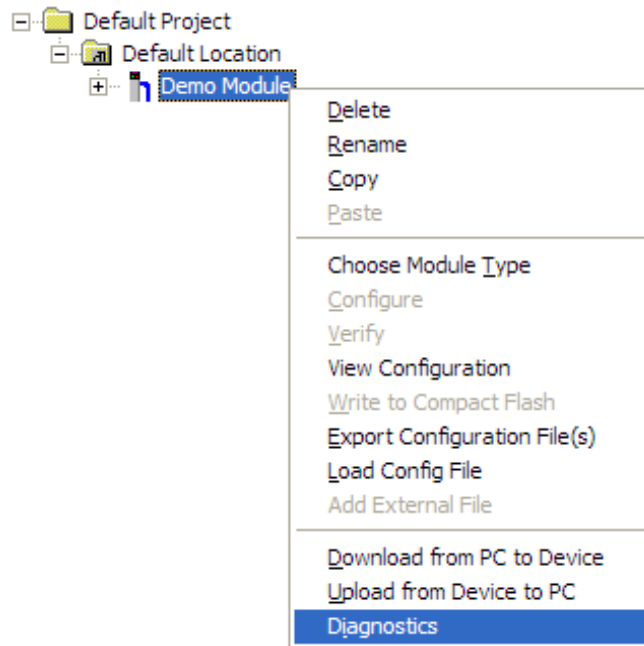

This action opens the *Diagnostics* dialog box.

- 3 Press [?] to open the *Main* menu.

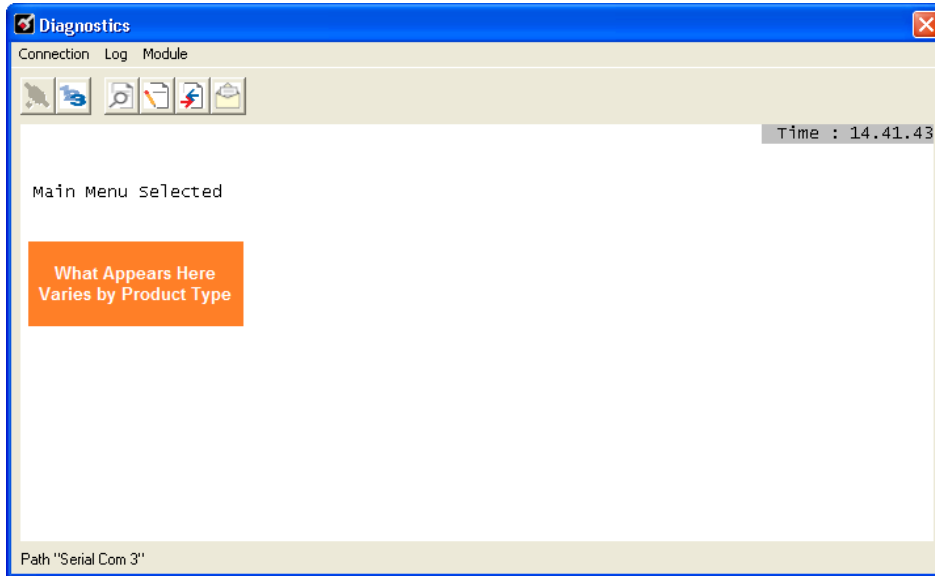

If there is no response from the module, follow these steps:

- 1 Click to configure the connection. On the *Connection Setup* dialog box, select a valid com port or other connection type supported by the module.

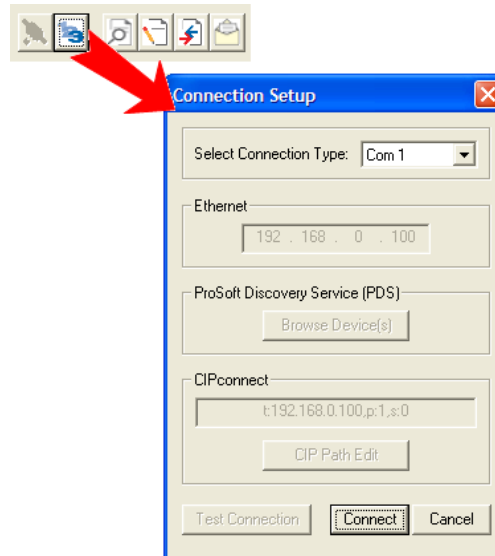

- 2 Verify that the null modem cable is connected properly between your computer's serial port and the module. A regular serial cable will not work.
- 3 On computers with more than one serial port, verify that your communication program is connected to the same port that is connected to the module.

If you are still not able to establish a connection, contact ProSoft Technology for assistance.

## 4.2.2 Navigation

All of the submenus for this module contain commands to redisplay the menu or return to the previous menu. You can always return from a submenu to the next higher menu by pressing **[M]** on your keyboard.

The organization of the menu structure is represented in simplified form in the following illustration:

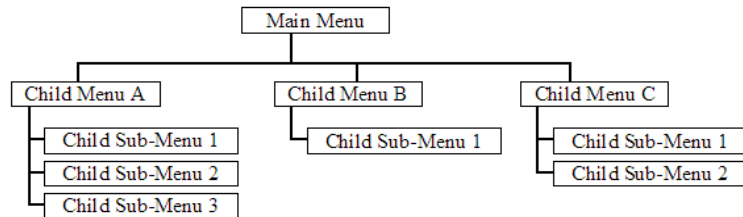

The remainder of this section shows the menus available for this module, and briefly discusses the commands available to you.

### Keystrokes

The keyboard commands on these menus are usually not case sensitive. You can enter most commands in lowercase or uppercase letters.

The menus use a few special characters (**?**, **-**, **+**, **@**) that must be entered exactly as shown. Some of these characters will require you to use the **SHIFT**, **CTRL**, or **ALT** keys to enter them correctly. For example, on US English keyboards, enter the **?** command as **SHIFT** and **/**.

Also, take care to distinguish the different uses for uppercase letter "eye" (**I**), lowercase letter "el" (**L**), and the number one (**1**). Likewise, uppercase letter "oh" (**O**) and the number zero (**0**) are not interchangeable. Although these characters look alike on the screen, they perform different actions on the module and may not be used interchangeably.

### 4.2.3 Main Menu

When you first connect to the module from your computer, your terminal screen will be blank. To activate the main menu, press the [?] key on your computer's keyboard. If the module is connected properly, the following menu will appear.

```
MVI-GEC COMMUNICATION MODULE MENU
?=Display Menu
B=Block Transfer Statistics
C=Module Configuration
R=Transfer Configuration from PC to MVI Unit
S=Transfer Configuration from MVI Unit to PC
U=Reset diagnostic data
V=Version Information
W=Warm Boot Module
Status: 1=Server 0, 2=Server 1, 3=Server 2, 4=Server 3, 5=Server 4
        E=Client 0, F=Client 1, G=Client 2, H=Client 3, I=Client 4
Cfg    : 6=Server 0, 7=Server 1, 8=Server 2, 9=Server 3, 0=Server 4
@=Network Menu      Esc=Exit Program
```

**Caution:** Some of the commands available to you from this menu are designed for advanced debugging and system testing only, and can cause the module to stop communicating with the processor or with other devices, resulting in potential data loss or other failures. Only use these commands if you are specifically directed to do so by ProSoft Technology Technical Support staff. Some of these command keys are not listed on the menu, but are active nevertheless. Please be careful when pressing keys so that you do not accidentally execute an unwanted command.

#### Redisplaying the Menu

Press [?] to display the current menu. Use this command when you are looking at a screen of data, and want to view the menu choices available to you.

#### Viewing Block Transfer Statistics

Press [B] to view the Block Transfer Statistics screen.

Use this command to display the configuration and statistics of the backplane data transfer operations between the module and the processor. The information on this screen can help determine if there are communication problems between the processor and the module.

**Tip:** Repeat this command at one-second intervals to determine the number of blocks transferred each second.

#### Viewing Module Configuration

Press [C] to view the *Module Configuration* screen.

Use this command to display the current configuration and statistics for the module.

### Transferring the Configuration File from the PC to the Module

On the Diagnostics Menu this is referred to as *Receive Module Configuration*.

Press **[R]** to receive (download) the configuration file from your PC to the module and store the file on the module's Compact Flash Card (Personality Module) or Flash RAM.

Press **[Y]** to confirm the file transfer, and then follow the instructions on the terminal screen to complete the file transfer process.

After the file has been successfully downloaded, the module will restart the program and load the new configuration information. Review the new configuration using menu commands **[6]** and **[0]** to verify that the module is configured correctly.

### Transferring the Configuration File from The Module to the PC

On the Diagnostics Menu this is referred to as *Send Module Configuration*.

Press **[S]** to send (upload) the configuration file from the module to your PC.

Press **[Y]** to confirm the file transfer, and then follow the instructions on the terminal screen to complete the file transfer process.

After the file has been successfully uploaded, you can open and edit the file to change the module's configuration.

### Resetting Diagnostic Data

Press **[U]** to reset the status counters for the Client and/or servers in the module.

### Viewing Version Information

Press **[V]** to view version information for the module.

Use this command to view the current version of the software for the module, as well as other important values. You may be asked to provide this information when calling for technical support on the product.

Values at the bottom of the display are important in determining module operation. The *Program Scan Counter* value is incremented each time a module's program cycle is complete.

**Tip:** Repeat this command at one-second intervals to determine the frequency of program execution.

### Warm Booting the Module

Press **[W]** from the *Main* menu to warm boot (restart) the module.

This command will cause the program to exit and reload, refreshing configuration parameters that must be set on program initialization. Only use this command if you must force the module to reboot.

Viewing Server Communication Status (Servers 0 to 4)

Use commands [1] [2] [3] [4] or [5] to view the communication status and statistics of the specified server. This information can be useful when troubleshooting communication problems.

```
SERVER 0 (Port 15000):
  Enabled           : YES
  State            : 1
  IP of Connected Host : C0680039
  Port of Connected Host : 1504
  Open Count       : 1
  Establish Count   : 1
  Close Count      : 0
  Receive Message Count : 125
  Receive Busy State : 0
  Receive Message Length : 0
  Receive Overflow Count : 0
  Transmit Message Count : 125
  Transmit Busy State : 0
  Transmit Message Length : 0
  Transmit Overflow Count : 0
  Timeout Error Count : 0
  Configuration Error Word : 0x0000
```

Viewing Client Communication Status (Clients 10 to 14)

Use commands [E] [F] [G] [H] or [I] to view the communication status and statistics of the specified client. This information can be useful when troubleshooting communication problems.

```
CLIENT 0:
  Connected State : 0
  State          : -1
  IP of Connected Host :
  Port of Connected Host : 0
  Receive Message Count : 0
  Receive Busy State : 0
  Receive Message Length : 0
  Receive Overflow Count : 0
  Receive Swap Type : NO
  Transmit Message Count : 0
  Transmit Busy State : 0
  Transmit Message Length : 0
  Transmit Overflow Count : 0
  Transmit Swap Type : NO
```

Viewing Server Configuration (Servers 0 to 4)

Use commands [6] [7] [8] [9] or [0] to view the configuration of the specified server.

```
SERVER 0 (Enabled - YES)
  Service Port : 15000
  Maximum Buffer Size : 4096
  Connection Timeout : 0
  Close Type : 0
```

Opening the Network Menu

Press [ @ ] to open the *Network* menu.

The *Network* menu allows you to send, receive and view the WATTCP.CFG file that contains the IP, gateway and other network specification information. For more information about this submenu, see Network Menu (page 55).

### Exiting the Program

Press **[ESC]** to restart the module and force all drivers to be loaded. The module will use the configuration stored in the module's Flash memory to configure the module.

### **4.2.4 Network Menu**

From the *IEC-870-5-104 Server* menu press **[@]** to display the *IEC-870-5-104 Network* menu screen. The *Network* menu allows you to send, receive, and view the WATTCP.CFG file that contains the IP and module addresses, and other network information.

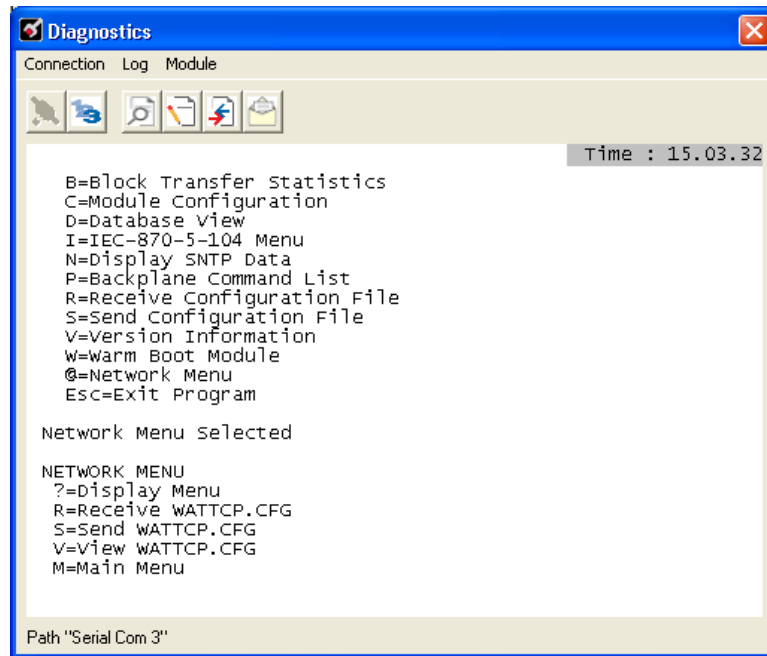

### Transferring WATTCP.CFG to the Module

Press **[R]** to transfer a new WATTCP.CFG file from the PC to the module. Use this command to change the network configuration for the module (for example, the module's IP address).

Press **[Y]** to confirm the file transfer, and then follow the instructions on the terminal screen to complete the file transfer process.

### Transferring WATTCP.CFG to the PC

Press **[S]** to transfer the WATTCP.CFG file from the module to your PC.

Press **[Y]** to confirm the file transfer, and then follow the instructions on the terminal screen to complete the file transfer process.

After the file has been successfully transferred, you can open and edit the file to change the module's network configuration.

Viewing the WATTCP.CFG File on the module

Press **[V]** to view the module's WATTCP.CFG file. Use this command to confirm the module's current network settings.

```
WATTCP.CFG FILE:
# ProLinx Communication Gateways, Inc.
# Default private class 3 address
my_ip=192.168.0.75
# Default class 3 network mask
netmask=255.255.255.0
# name server 1 up to 9 may be included
# nameserver=xxx.xxx.xxx.xxx
# name server 2
# nameserver=xxx.xxx.xxx.xxx
# The gateway I wish to use
gateway=192.168.0.1
# some networks (class 2) require all three parameters
# gateway, network, subnetmask
# gateway 192.168.0.1, 192.168.0.0, 255.255.255.0
# The name of my network
# domainlist="mynetwork.name"
```

Returning to the Main Menu

Press **[M]** to return to the *Main* menu.

### **4.3 Reading Status Data from the Module**

The MVI69-GEC module returns a status data set to the processor in each read block. This data is transferred to the processor continuously with each read block.

The Configuration/Debug port provides the following functionality:

- Full view of the module's configuration data
- View of the module's status data
- Version Information
- Control over the module (warm boot and cold boot)
- Facility to upload and download the module's configuration file



## 5 Reference

### *In This Chapter*

❖ Product Specifications .....	60
❖ Functional Overview .....	63
❖ Cable Connections .....	78
❖ MVI69-GEC Status Data For Block Transfer .....	83

## 5.1 Product Specifications

The MVI69 Generic ASCII Ethernet Interface module is designed to allow CompactLogix or MicroLogix processors to interface easily with ASCII devices using the TCP/IP protocol and the CompactLogix or MicroLogix processor. Compatible devices may be either ASCII instruments with Ethernet built-in or Ethernet connection via a thin server to the existing ASCII device.

Five servers and clients are present on the module permitting both the reception and transmission of data between the Rockwell Automation processor and attached devices.

The MVI69-GEC module is a powerful communication interface for CompactLogix or MicroLogix processors. Developed under license from Rockwell Automation, the module incorporates proprietary backplane technology that enables powerful data access between the module and the CompactLogix or MicroLogix processor.

### 5.1.1 General Specifications

- Single-slot, 1769 backplane-compatible
- The module is recognized as an Input/Output module and has access to processor memory for data transfer between processor and module.
- Ladder Logic is used for data transfer between module and processor. Sample ladder file included.
- Configuration data obtained from configuration text file downloaded to module. Sample configuration file included.
- Supports CompactLogix processors with 1769 I/O bus capability and at least 800 mA of 5 Vdc backplane current available.
- Also supports MicroLogix 1500 LRP

### 5.1.2 Hardware Specifications

Specification	Description
Dimensions	Standard 1769 single-slot module
Current Load	800 mA max @ 5 Vdc Power supply distance rating of 2 (L43 and L45 installations on first 2 slots of 1769 bus)
Operating Temp.	0°C to 60°C (32°F to 140°F)
Storage Temp.	-40°C to 85°C (-40°F to 185°F)
Relative Humidity	5% to 95% (without condensation)
LED Indicators	Power and Module Status Application Status CFG Port Activity Ethernet Port Activity Error Status
CFG Port (CFG)	RJ45 (DB-9M with supplied cable) RS-232 only No hardware handshaking
App Port (Ethernet modules)	10/100 Base-T Ethernet compatible interface Electrical Isolation 1500 Vrms at 50 Hz to 60 Hz for 60 s, applied as specified in section 5.3.2 of IEC 60950: 1991 Ethernet Broadcast Storm Resiliency = less than or equal to 5000 [ARP] frames-per-second and less than or equal to 5 minutes duration
Shipped with Unit	RJ45 to DB-9M cables for each port 6-foot RS-232 configuration cable

### **5.1.3 Functional Specifications - MVI69-GEC**

- Five Servers and Clients to receive and/or transmit data
- 10/100 Base-T Ethernet-compatible interface
- Configurable parameters
  - Service port number
  - Connection timeout
  - Close type
- Simple ladder logic operation
- Setup and monitoring through RS-Logix 5000 (CompactLogix) or RS-Logix 500 (MicroLogix) software and user-constructed configuration file (GEC.CFG)
- CompactLogix backplane interface via I/O access
- Each Server monitors
  - State
  - IP and port number of connected Client
  - Error codes
- Each Client monitors
  - State
  - IP and port number of connected Server
  - Message related parameters
- ASCII character strings up to 2048 characters in length supported
- Full hardware handshaking control, providing radio, modem, and multi-drop support
- User-definable module memory usage, supporting the storage and transfer of up to 4000 bytes to/from the control processor
- Module error and status conditions returned to processor for diagnostic purposes
  - Module status
  - Port error status word (bit mapped)
  - Port receive state
  - Port receive character count
  - Port receive block count
  - Port transmit state
  - Port transmit character count
  - Port transmit block count
- All data related to the module is contained in a single controller tag with defined objects to simplify configuration, monitoring, and interfacing with the module
- Module configuration and communication configuration data is transferred to the MVI69-GEC via a pre-defined user data type in the processor

## 5.2 Functional Overview

### 5.2.1 General Concepts

The following discussion explains several concepts that are important for understanding module operation.

#### Module Power Up

On power up the module begins performing the following logical functions:

- 1 Initialize hardware components
- 2 Initialize processor backplane driver
- 3 Test and clear all RAM
- 4 Initialize the serial communication ports
- 5 Initialize the TCP/IP stack and Ethernet interface
- 6 Initialize servers and clients
- 7 Set up the serial communication interface for the debug/configuration port

After the module has received the configuration, the module will begin receiving and transmitting messages with devices on the Ethernet network.

#### Main Logic Loop

Upon completing the power up configuration process, the module enters an infinite loop that performs the functions shown in the following diagram.

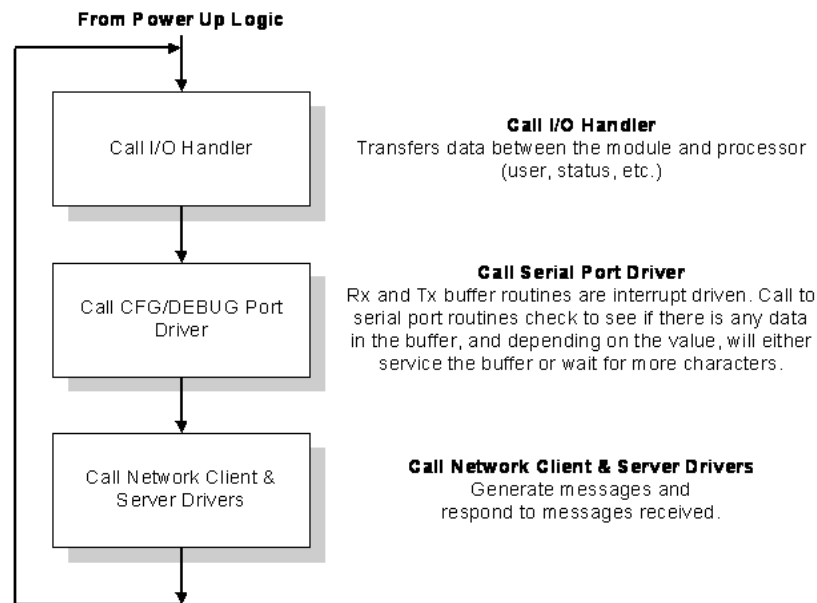

### Backplane Data Transfer

The MVI69-GEC module communicates directly over the CompactLogix or MicroLogix backplane. Data travels between the module and the processor across the backplane using the module's input and output images. The update frequency of the data is determined by the scan rate defined by the user for the module and the communication load on the module. Typical updates are in the range of 1 to 10 milliseconds.

Data received by the servers is placed in the module's input image. This data is processed by the ladder logic in the processor. The input image for the module is set to 60 words. This large data area permits fast throughput of data between the module and the processor.

The processor inserts data in the module's output image to transfer to the module. The module's program extracts the data and transmits the data out to the Ethernet network. Each message is directed to a server that is connected to a client in a remote host. This large data area permits fast throughput of data from the processor to the module.

The following illustration shows the data transfer method used to move data between the processor, the MVI69-GEC module, and the Ethernet network.

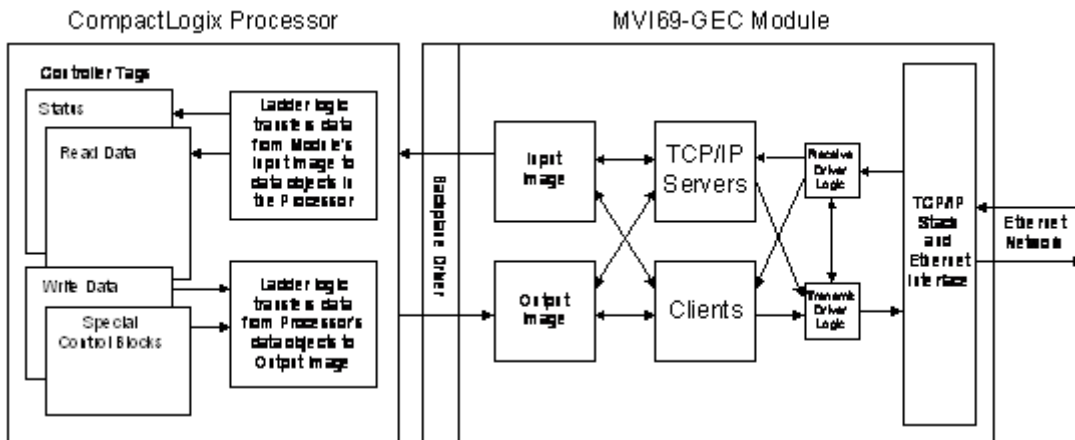

As shown in the previous diagram, all data transferred between the module and the processor over the backplane is through the input and output images. Ladder logic must be written in the processor to interface the input and output image data defined in the controller tags. The user is responsible for handling and interpreting all data received on the application ports and transferred to the input image. Additionally, the user is responsible for constructing messages to be transferred out of the servers by building the messages in the output image of the module.

Normal Data Transfer

Normal data transfer includes the transferring of data received or to be transmitted on the servers and the status data. These data are transferred through read (input image) and write (output image) blocks. Refer to Module Configuration for a description of the data objects used with the blocks and the ladder logic required. The following topics discuss the structure and function of each block.

**Read Block**

These blocks of data transfer information from the module to the PLC processor. When data is received on one of the servers, a data block is built. The structure of this block type is shown in the following table.

	<b>Word Offset</b>	<b>Description</b>										
	0	Block Sequence Number (Bumped each scan by module)										
Received Data	1	Server Number for data received. If the word contains a value of -1, -2, -3 or -4, no receive data is present and the block contains status data. If the word contains a value from 0 to 4, the block contains data from one of the servers in the module.										
		<table border="1"> <thead> <tr> <th>Word 1 value</th> <th>Description</th> </tr> </thead> <tbody> <tr> <td>-1</td> <td>State of servers 0, 1 and 2</td> </tr> <tr> <td>-2</td> <td>State of servers 3 and 4</td> </tr> <tr> <td>-3</td> <td>State of clients 0, 1 and 2</td> </tr> <tr> <td>-4</td> <td>State of clients 3 and 4</td> </tr> </tbody> </table>	Word 1 value	Description	-1	State of servers 0, 1 and 2	-2	State of servers 3 and 4	-3	State of clients 0, 1 and 2	-4	State of clients 3 and 4
Word 1 value	Description											
-1	State of servers 0, 1 and 2											
-2	State of servers 3 and 4											
-3	State of clients 0, 1 and 2											
-4	State of clients 3 and 4											
	2	Number of characters (0 to 110) in receive block (3 to 57). If the receive data in the module is larger than 110 bytes (55 words), multiple blocks will be transferred. Any block with a value of -1 in this field represents the first or continuation block and the block contains 110 bytes (55 words) of data. The last block of data will contain a positive number in this field that represents the number of characters in the last block.										
	3 to 57	110 bytes (55 words) of data received for specified server.										
	58	Server 0 State										
	59	Server 1 State										
	60	Server 2 State										
	61	Server 3 State										
	62	Server 4 State										
	63	LSB: Number of characters processed from last write block. MSB: Index of the C/S that requested the write (0 to 4, 10 to 14, or 0xFF).										

The Block Sequence Number (word 0) is an index value used to signal to the processor that a new block is ready for processing. The ladder logic must recognize a change in this value and process the data encapsulated. If data is available for a server, a block containing data received is passed to the processor. The value at word 1 in the block contains the server index (0 to 4) that is sending the data to the processor. Word 2 of the input image determines the number of characters (or bytes) in the data area of the block. If the server receives a message longer than 110 bytes (55 words), it must send the received message in multiple blocks to the processor. In this case, the byte count field of the block will be set to -1 for each block where more than 110 characters are being sent by the server. Each block with a byte count field of -1 contains 110 bytes (55 words) of data. The data set is located in the block starting at word offset 3. When the last block of data to send by the server is less than or equal to 110 bytes (55 words), the byte count field will be set to a number from 1 to 110. This signifies to the processor that this is the last block. The ladder logic must handle data received on each server enabled in the module.

If no data is available, the module will page one of the two status data images to the processor. If word 1 of the Input Image block is set to -1, the data for the first three servers, the product and block transfer data is sent in the block. The format of this block is as follows:

Object In GECInStat	Block Offset Start	Description
Seq Number	0	Sequence number for this block.
Server Index	1	For this status data block, this word is set to a value of -1.
PassCnt	2	Program cycle counter
Product	3	Product name as ASCII string
Rev	5	Revision level as ASCII string
OP	7	Operating system level as ASCII string
Run	9	Run number as ASCII string
BlkErrs.Read	11	Number of blocks transferred from module to processor
BlkErrs.Write	12	Number of blocks transferred from processor to module
BlkErrs.Parse	13	Number of blocks parsed by module
BlkErrs.Err	14	Number of block errors in module
Server[0].Enabled	15	This flag defines if the server is utilized. A value of 0 indicates the server is not used. Any other value indicates the server is used.
Server[0].State	16	This flag defines the current state of the server.
Server[0].IP	17	This double-word value contains the IP address of the client connected to the server.
Server[0].Port	19	This word value contains the port address for the client connected to the server.
Server[0].Open	20	This status value contains the total number of times the server performed an open operation.
Server[0].Established	21	This status value contains the total number of times a connection was established on the socket.
Server[0].Closed	22	This status value contains the total number of times a close operation was performed on the socket.

<b>Object In GECInStat</b>	<b>Block Offset Start</b>	<b>Description</b>
Server[0].RxCount	23	This status value contains the total number of messages received by the server.
Server[0].RxOverflow	24	This status value contains the total number of messages received that exceed the specified buffer size for the server.
Server[0].TxCount	25	This status value contains the total number of messages transmitted by the server.
Server[0].TxOverflow	26	This status value contains the total number of transmit messages that exceeded the specified maximum buffer size for the server.
Server[0].Timeout	27	This status value contains the total number of times a connection timeout occurred on the socket.
Server[0].CfgErrWord	28	This bit mapped word defines the configuration errors for the server.
Server[1].Enabled	29	This flag defines if the server is utilized. A value of 0 indicates the server is not used. Any other value indicates the server is used.
Server[1].State	30	This flag defines the current state of the server.
Server[1].IP	31	This double-word value contains the IP address of the client connected to the server.
Server[1].Port	33	This word value contains the port address for the client connected to the server.
Server[1].Open	34	This status value contains the total number of times the server performed an open operation.
Server[1].Established	35	This status value contains the total number of times a connection was established on the socket.
Server[1].Closed	36	This status value contains the total number of times a close operation was performed on the socket.
Server[1].RxCount	37	This status value contains the total number of messages received by the server.
Server[1].RxOverflow	38	This status value contains the total number of messages received that exceed the specified buffer size for the server.
Server[1].TxCount	39	This status value contains the total number of messages transmitted by the server.
Server[1].TxOverflow	40	This status value contains the total number of transmit messages that exceeded the specified maximum buffer size for the server.
Server[1].Timeout	41	This status value contains the total number of times a connection timeout occurred on the socket.
Server[1].CfgErrWord	42	This bit mapped word defines the configuration errors for the server.
Server[2].Enabled	43	This flag defines if the server is utilized. A value of 0 indicates the server is not used. Any other value indicates the server is used.
Server[2].State	44	This flag defines the current state of the server.
Server[2].IP	45	This double-word value contains the IP address of the client connected to the server.
Server[2].Port	47	This word value contains the port address for the client connected to the server.
Server[2].Open	48	This status value contains the total number of times the server performed an open operation.

Object In GECInStat	Block Offset Start	Description
Server[2].Established	49	This status value contains the total number of times a connection was established on the socket.
Server[2].Closed	50	This status value contains the total number of times a close operation was performed on the socket.
Server[2].RxCount	51	This status value contains the total number of messages received by the server.
Server[2].RxOverflow	52	This status value contains the total number of messages received that exceed the specified buffer size for the server.
Server[2].TxCount	53	This status value contains the total number of messages transmitted by the server.
Server[2].TxOverflow	54	This status value contains the total number of transmit messages that exceeded the specified maximum buffer size for the server.
Server[2].Timeout	55	This status value contains the total number of times a connection timeout occurred on the socket.
Server[2].CfgErrWord	56	This bit mapped word defines the configuration errors for the server.
Reserved	57 to 62	This data area is reserved for future use.
Last Write Count	63	This word contains the number of characters written on server from last Input Image block.

If word 1 of the Input Image block is set to -2, the data for the last two servers is passed to the processor. The format of this block is as follows:

Object In GECInStat	Block Offset Start	Description
Seq Number	0	Sequence number for this block.
Server Index	1	For this status data block, this word is set to a value of -2.
PassCnt	2	Program cycle counter
Product	3	Product name as ASCII string
Rev	5	Revision level as ASCII string
OP	7	Operating system level as ASCII string
Run	9	Run number as ASCII string
BlkErrs.Read	11	Number of blocks transferred from module to processor
BlkErrs.Write	12	Number of blocks transferred from processor to module
BlkErrs.Parse	13	Number of blocks parsed by module
BlkErrs.Err	14	Number of block errors in module
Server[3].Enabled	15	This flag defines if the server is utilized. A value of 0 indicates the server is not used. Any other value indicates the server is used.
Server[3].State	16	This flag defines the current state of the server.
Server[3].IP	17	This double-word value contains the IP address of the client connected to the server.
Server[3].Port	19	This word value contains the port address for the client connected to the server.
Server[3].Open	20	This status value contains the total number of times the server performed an open operation.

<b>Object In GECInStat</b>	<b>Block Offset Start</b>	<b>Description</b>
Server[3].Established	21	This status value contains the total number of times a connection was established on the socket.
Server[3].Closed	22	This status value contains the total number of times a close operation was performed on the socket.
Server[3].RxCount	23	This status value contains the total number of messages received by the server.
Server[3].RxOverflow	24	This status value contains the total number of messages received that exceed the specified buffer size for the server.
Server[3].TxCount	25	This status value contains the total number of messages transmitted by the server.
Server[3].TxOverflow	26	This status value contains the total number of transmit messages that exceeded the specified maximum buffer size for the server.
Server[3].Timeout	27	This status value contains the total number of times a connection timeout occurred on the socket.
Server[3].CfgErrWord	28	This bit mapped word defines the configuration errors for the server.
Server[4].Enabled	29	This flag defines if the server is utilized. A value of 0 indicates the server is not used. Any other value indicates the server is used.
Server[4].State	30	This flag defines the current state of the server.
Server[4].IP	31	This double-word value contains the IP address of the client connected to the server.
Server[4].Port	33	This word value contains the port address for the client connected to the server.
Server[4].Open	34	This status value contains the total number of times the server performed an open operation.
Server[4].Established	35	This status value contains the total number of times a connection was established on the socket.
Server[4].Closed	36	This status value contains the total number of times a close operation was performed on the socket.
Server[4].RxCount	37	This status value contains the total number of messages received by the server.
Server[4].RxOverflow	38	This status value contains the total number of messages received that exceed the specified buffer size for the server.
Server[4].TxCount	39	This status value contains the total number of messages transmitted by the server.
Server[4].TxOverflow	40	This status value contains the total number of transmit messages that exceeded the specified maximum buffer size for the server.
Server[4].Timeout	41	This status value contains the total number of times a connection timeout occurred on the socket.
Server[4].CfgErrWord	42	This bit mapped word defines the configuration errors for the server.
Reserved	43 to 62	This data area is reserved for future use.
Last Write Count	63	This word contains the number of characters written on server from last Input Image block.

If word 1 of the Input Image block is set to -3, the data for the first three clients is passed to the processor. The format of this block is as follows:

Parameter	Block Offset Start	Description
Seq Number	0	Sequence number for this block.
Server Index	1	For this status data block, this word is set to a value of -3.
PassCnt	2	Program cycle counter
Product	3	Product name as ASCII string
Rev	5	Revision level as ASCII string
OP	7	Operating system level as ASCII string
Run	9	Run number as ASCII string
BlkErrs.Read	11	Number of blocks transferred from module to processor
BlkErrs.Write	12	Number of blocks transferred from processor to module
BlkErrs.Parse	13	Number of blocks parsed by module
BlkErrs.Err	14	Number of block errors in module
Client[0].Connected	15	This flag defines if the client is utilized and connected to a server. A value of 0 indicates the client is not connected and can be utilized for a connection. Any other value indicates the client is connected and being used.
Client[0].State	16	This flag defines the current state of the client.
Client[0].IP	17	This double-word value contains the IP address of the server connected to the client.
Client[0].Port	19	This word value contains the port address for the server connected to the client.
Client[0].RxCount	20	This status value contains the total number of messages received by the client.
Client[0].RxOverflow	21	This status value contains the total number of messages received that exceed the specified buffer size for the client.
Client[0].TxCount	22	This status value contains the total number of messages transmitted by the client.
Client[0].TxOverflow	23	This status value contains the total number of transmit messages that exceeded the specified maximum buffer size for the client.
Client[0].spare	24	Reserved for future use
Client[1].Connected	25	This flag defines if the client is utilized and connected to a server. A value of 0 indicates the client is not connected and can be utilized for a connection. Any other value indicates the client is connected and being used.
Client[1].State	26	This flag defines the current state of the client.
Client[1].IP	27	This double-word value contains the IP address of the server connected to the client.
Client[1].Port	29	This word value contains the port address for the server connected to the client.
Client[1].RxCount	30	This status value contains the total number of messages received by the client.
Client[1].RxOverflow	31	This status value contains the total number of messages received that exceed the specified buffer size for the client.
Client[1].TxCount	32	This status value contains the total number of messages transmitted by the client.

Parameter	Block Offset Start	Description
Client[1].TxOverflow	33	This status value contains the total number of transmit messages that exceeded the specified maximum buffer size for the client.
Client[1].spare	34	Reserved for future use
Client[2].Connected	35	This flag defines if the client is utilized and connected to a server. A value of 0 indicates the client is not connected and can be utilized for a connection. Any other value indicates the client is connected and being used.
Client[2].State	36	This flag defines the current state of the client.
Client[2].IP	37	This double-word value contains the IP address of the server connected to the client.
Client[2].Port	39	This word value contains the port address for the server connected to the client.
Client[2].RxCount	40	This status value contains the total number of messages received by the client.
Client[2].RxOverflow	41	This status value contains the total number of messages received that exceed the specified buffer size for the client.
Client[2].TxCount	42	This status value contains the total number of messages transmitted by the client.
Client[2].TxOverflow	43	This status value contains the total number of transmit messages that exceeded the specified maximum buffer size for the client.
Client[2].spare	44	Reserved for future use
Reserved	45 to 57	This data area is reserved for future use.
Server States	58 to 62	State of each of the five servers.
Last Write Count	63	This word contains the number of characters written on server from last BTR block.

If word 1 of the Input Image block is set to -4, the data for the last two clients is passed to the processor. The format of this block is as follows:

Parameter	Block Offset Start	Description
Seq Number	0	Sequence number for this block.
Server Index	1	For this status data block, this word is set to a value of -4.
PassCnt	2	Program cycle counter
Product	3	Product name as ASCII string
Rev	5	Revision level as ASCII string
OP	7	Operating system level as ASCII string
Run	9	Run number as ASCII string
BlkErrs.Read	11	Number of blocks transferred from module to processor
BlkErrs.Write	12	Number of blocks transferred from processor to module
BlkErrs.Parse	13	Number of blocks parsed by module
BlkErrs.Err	14	Number of block errors in module

<b>Parameter</b>	<b>Block Offset Start</b>	<b>Description</b>
Client[3].Connected	15	This flag defines if the client is utilized and connected to a server. A value of 0 indicates the client is not connected and can be utilized for a connection. Any other value indicates the client is connected and being used.
Client[3].State	16	This flag defines the current state of the client.
Client[3].IP	17	This double-word value contains the IP address of the server connected to the client.
Client[3].Port	19	This word value contains the port address for the server connected to the client.
Client[3].RxCount	20	This status value contains the total number of messages received by the client.
Client[3].RxOverflow	21	This status value contains the total number of messages received that exceed the specified buffer size for the client.
Client[3].TxCount	22	This status value contains the total number of messages transmitted by the client.
Client[3].TxOverflow	23	This status value contains the total number of transmit messages that exceeded the specified maximum buffer size for the client.
Client[3].spare	24	Reserved for future use
Client[4].Connected	25	This flag defines if the client is utilized and connected to a server. A value of 0 indicates the client is not connected and can be utilized for a connection. Any other value indicates the client is connected and being used.
Client[4].State	26	This flag defines the current state of the client.
Client[4].IP	27	This double-word value contains the IP address of the server connected to the client.
Client[4].Port	29	This word value contains the port address for the server connected to the client.
Client[4].RxCount	30	This status value contains the total number of messages received by the client.
Client[4].RxOverflow	31	This status value contains the total number of messages received that exceed the specified buffer size for the client.
Client[4].TxCount	32	This status value contains the total number of messages transmitted by the client.
Client[4].TxOverflow	33	This status value contains the total number of transmit messages that exceeded the specified maximum buffer size for the client.
Client[4].spare	34	Reserved for future use
Reserved	35 to 57	This data area is reserved for future use.
Server States	58 to 62	State of each of the five servers.
Last Write Count	63	This word contains the number of characters written on server from last BTR block.

### Write Block

These blocks of data transfer information from the PLC processor to the module. The structure of the Output Image blocks used to transfer this data is shown in the following table.

	Word Offset	Description
	0	Block Sequence Number (Read block number as set by module)
Transmit Data	1	Server Number for data to transmit. If the word contains a value of -1, no transmit data is present. If the word contains a value from 0 to maximum number of servers -1, the block contains data to send to the specified server in the module.
	2	Number of characters to transmit to server. Each block can transmit up to 118 bytes (59 words) of data. If this word contains a value of -1, the block contains 118 bytes (59 words) of data and more blocks of data are to follow. When the module received the last block containing a positive value representing the number of bytes in the block, the server will transmit the data to the client.
	3 to 61	118 bytes (59 words) of data to transmit on specified server.
	62	Server Control Word
	63	Module Control Word Transmit Data

The Block Sequence Number is received on the last read block transfer through the Input Image on the module. The ladder logic should copy this value from word 0 of the Input Image to word 0 of Output Image in the ladder logic. This is the last operation performed when constructing the write block. The module's program will trigger the process write block function when a new value is recognized in word 0 of the Output Image.

Word 1 of the block defines the server index that should receive the message. If the word is set to a value of -1, there is no data in the message. A value of 0 to 4 will cause the enclosed message to be sent to the server if the message length is set to a value other than zero and the server has an open connection. Word 2 of the block defines the length of data in the block. Up to 110 bytes (55 words) of data can be sent in each block starting at word offset 3 in the block. If the message to be sent to a server is longer than 110 bytes (55 words), multiple blocks are required. As long as more than 110 bytes (55 words) are required to send, the message length field should be set to a value of -1 and 110 bytes (55 words) of data should be placed in the block. When 110 or fewer bytes (55 words) remain to be sent, the message length field should be set to that value and the remaining data placed in the block. The server will accept messages up to a length of 4096 bytes (2048 words). If a message longer than 4096 bytes (2048 words) is sent to a server, a transmit overflow error will be recorded and the message will be sent when 4096 bytes (2048 words) are received. The remaining part of the message will be sent as it is received.

The last two words of the image control the server or the module. The server control word (word 62) controls the server. The following table lists the values recognized by the module:

Code	Definition
0	No operation to perform
1	Close socket after transmit operation
2	Abort socket after transmit operation

If a value of 0 is present in the field, no action is taken by the server. If a value of 1 is present in the field, the server will gently close the socket after it transmits the message contained in the block. If a value of 2 is present, the server will send the message contained in the block and then force the connection closed by sending a reset message to the client.

Word 63 is utilized to control the module. The following commands are recognized by the module as displayed in the following table.

Code	Definition
0	No operation to perform
-1	Warm boot module
-2	Cold boot module
-30	Close server 0
-31	Close server 1
-32	Close server 2
-33	Close server 3
-34	Close server 4

The module performs the action specified in the command control word.

**Special Block: Structure of Client Connection Request Data**

Word Offset	Description
0	Block Sequence Number (Read block number as set by module)
1	Client to utilized for connection (10 to 14)
2	Reserved for future use.
3 to 6	IP address of server to which connection will be made. Each word contains one of the digits of a dotted notation IP address.
7	Service port in server to which connection will be made. This service must be available in the server for the connection to succeed.
8	Swap Rx data bytes (0 = No, not 0 = Yes)
9	Swap Tx data bytes (0 = No, not 0 = Yes)
10	Client TimeOut value in milliseconds. The client will close the connection with remote Server after the specified milliseconds once there is no data transfer between the client and the remote Server. A value of 0 will keep the connection open indefinitely.
11 to 62	Not used for this block of data
63	The Module/Client control word contains a value of -100 for this special block.

### Handling Multiple Blocks

An important concept to understand about the MVI69-GEC module is how multiple blocks are handled.

The buffer size supports 4096 bytes (2048 words), but the module can only send 110 bytes (55 words) at each scan to the processor. For example, if a device sends a message that contains 550 bytes (225 words) to the module, it will break it down to five blocks of 110 bytes (55 words). The first four blocks will set the number of characters parameter to -1, indicating that each block is part of the same message. The last block will have the number of characters parameter set to 110, indicating that there are no more blocks from that message.

The same holds true for writing data from the processor to the module, in which case you can write 118 bytes (59 words) each time to the module. The module buffers all the data until it receives a block that has the number of characters parameter set to  $\geq 0$ . In this case, it sends all data to the client connected to that server.

The ladder logic should handle multiple blocks. The main example ladder logic is very simple and will only handle up to 110 bytes (55 words) because it does not check the status of the number of characters parameter.

**Important:** You should be aware that messages are usually broken down into smaller frames by the IP layer in a specific LAN or WAN according to the Maximum Transmit Unit (MTU) of the network.

For example, a message that contains 2000 bytes (1000 words) can be broken down into two messages by the IP layer in the network (after it is sent to the module). The same issue is applied when a client sends data to the server; although a client sends a single message to the module, it could be broken down into smaller fragments before it gets to the module. In this case, the module would interpret it as two different messages.

It is the application layer's responsibility to define when a message is finished. Therefore, you should consider using some kind of control that allows the ladder to identify different messages as part of a single message. This could be accomplished by using a specific character at the end of each message or by using a fixed length for each message.

### Network Data Transfer

In order for data to be transferred between the module and another device, a TCP/IP connection must be made between a client and a server on the module. The MVI69-GEC module contains five servers that listen on the user assigned service ports waiting for a connection. When a client device wishes to send data to the module, it must open a TCP/IP connection to the module. After the connection is established, either device can send and receive data. When either device is finished with the connection, the connection must be closed. This operation can be initiated from either end device.

The MVI69-GEC module servers and clients are configured to handle their TCP/IP session independently. The user parameter Connection Timeout is utilized to determine the amount of time a connection can remain idle before the server will close the connection. If the parameter is set to 0, the server will not perform the timeout logic and the socket will never be closed by the server on an idle condition. If this feature is utilized, it can prevent connections that may be lost and were not properly closed. After the connection is established, the ladder logic should verify that the client had not been communicating for some time and close the connection.

Each server on the module is assigned its own server port number. This does not mean that two or more servers cannot share the same port number. In fact this might be desirable in some instances. It is up to the ladder logic to keep track of each message and to insure that a request/response transaction is associated with the correct connection. Information to keep track of each connection is passed in each input image. The status data set provides the IP address and TCP port address for the connection on each server. Each message transferred between the module and the processor has a server index word. This word associates the message with a server, which is associated with a connection to a specific IP address and TCP port address. Therefore, each connection is specified to the processor by the server index. The following illustration shows a snapshot of the modules status data:

Server	Status Data	Description of Server
Server 0	IP of Host (192.168.0.100) Port of Host (1243) State = 1	This server is connected (State=1) to IP address 192.168.0.100 on TCP port 1243.
Server 1	IP of Host (192.168.0.100) Port of Host (1244) State = 1	This server is connected (State=1) to IP address 192.168.0.100 on TCP port 1244.
Server 2	IP of Host (192.168.0.101) Port of Host (56443) State = 1	This server is connected (State=1) to IP address 192.168.0.101 on TCP port 56443.
Server 3	IP of Host (192.168.0.102) Port of Host (7943) State = 1	This server is connected (State=1) to IP address 192.168.0.102 on TCP port 7943.
Server 4	IP of Host (0.0.0.0) Port of Host (0) State = 0	This server is not connected (State not equal to 1) and is waiting for a connection.

Ladder logic can send messages to the clients connected to servers 0 to 3. Messages sent to server 4 will not be sent from the module because there is no connection active on that server.

Each server has a state value in the status data area. This value is utilized by the ladder logic to determine if a connection is present on server. The following table defines the state status values used by each server:

State Value	Definition
-1	Server is initializing and is being set up to listen.
0	The server is waiting for a client to establish a connection.
1	The server has established a connection with a client and can send or receive data.
1000	The server has initiated a close operation on the connection.
1001	The server is waiting for the close on the connection to complete.
1002	The server is issuing an abort (reset) on the connection. The socket is forced closed.

Ladder logic should only direct messages to servers that have a state status value of 1. The module will ignore all messages sent to servers with any other state value.

When the ladder logic sends a message to a server, it can request that the socket be closed after the message is sent. The server control word in the output image is used for this purpose. Place a value of 1 in this register to gently close the connection after the message is sent. If a value of 2 is placed in the register, the server will abort the connection to force the socket closed (send a message with the Reset Flag set to the client). Most applications will have the client close the socket.

## 5.3 Cable Connections

The MVI69-GEC module has the following functional communication connections installed:

- One Ethernet port (RJ45 connector)
- One RS-232 Configuration/Debug port (RJ45 connector)

### 5.3.1 Ethernet Connection

The MVI69-GEC module has an RJ45 port located on the front of the module, labeled *Ethernet*, for use with the TCP/IP network. The module is connected to the Ethernet network using an Ethernet cable between the module's Ethernet port and an Ethernet switch or hub.

**Note:** Depending on hardware configuration, you may see more than one RJ45 port on the module. The Ethernet port is labeled *Ethernet*.

**Warning:** The MVI69-GEC module is NOT compatible with Power Over Ethernet (IEEE802.3af / IEEE802.3at) networks. Do NOT connect the module to Ethernet devices, hubs, switches or networks that supply AC or DC power over the Ethernet cable. Failure to observe this precaution may result in damage to hardware, or injury to personnel.

**Important:** The module requires a static (fixed) IP address that is not shared with any other device on the Ethernet network. Obtain a list of suitable IP addresses from your network administrator BEFORE configuring the Ethernet port on this module.

### Ethernet Port Configuration - wattcp.cfg

The wattcp.cfg file must be set up properly in order to use a TCP/IP network connection. You can view the current network configuration in *ProSoft Configuration Builder (PCB)*, as shown:

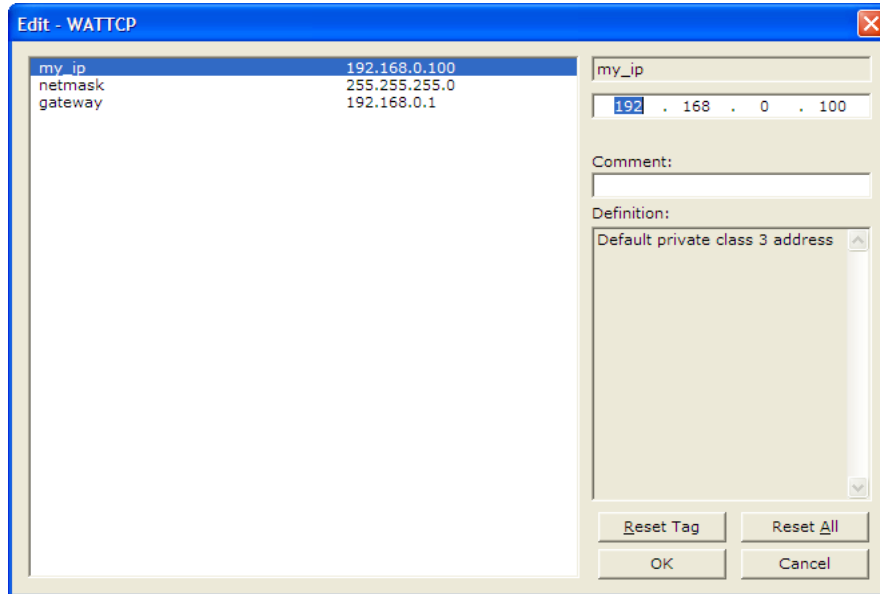

You may also view the network configuration using a PC serial port connection and an ASCII terminal program (like Windows HyperTerminal) by selecting **[@]** (Network Menu) and **[V]** (View) options when connected to the Debug port. For more information on serial port access, see the chapter on Diagnostics and Troubleshooting (page 45).

### **5.3.2 RS-232 Configuration/Debug Port**

This port is physically an RJ45 connection. An RJ45 to DB-9 adapter cable is included with the module. This port permits a PC based terminal emulation program to view configuration and status data in the module and to control the module. The cable for communications on this port is shown in the following diagram:

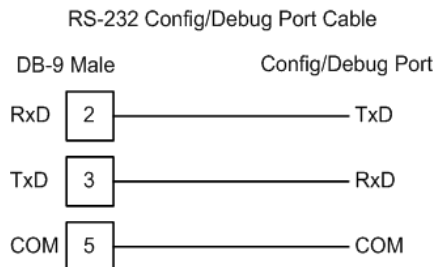

Disabling the RSLinx Driver for the Com Port on the PC

The communication port driver in *RSLinx* can occasionally prevent other applications from using the PC's COM port. If you are not able to connect to the module's configuration/debug port using *ProSoft Configuration Builder (PCB)*, *HyperTerminal* or another terminal emulator, follow these steps to disable the *RSLinx* Driver.

- 1 Open *RSLinx* and go to **COMMUNICATIONS>RSWHO**
- 2 Make sure that you are not actively browsing using the driver that you wish to stop. The following shows an actively browsed network:

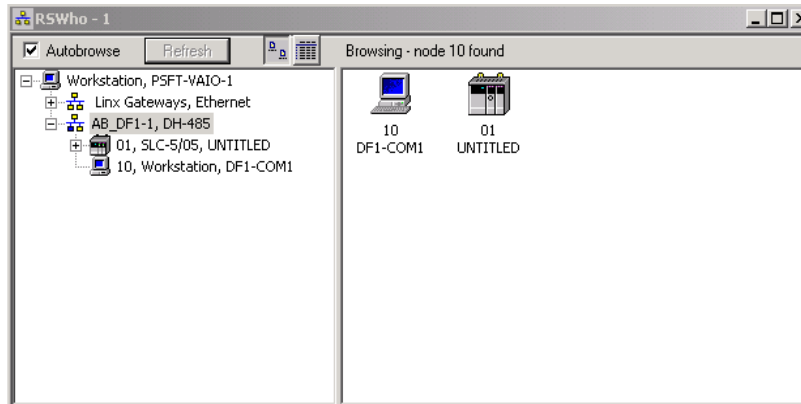

- 3 Notice how the DF1 driver is opened, and the driver is looking for a processor on node 1. If the network is being browsed, then you will not be able to stop this driver. To stop the driver your *RSWho* screen should look like this:

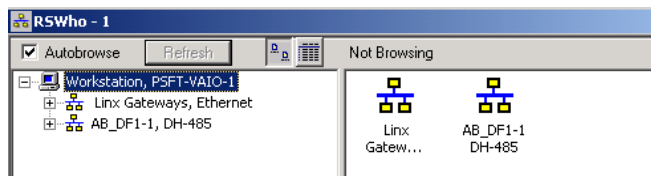

Branches are displayed or hidden by clicking on the  or the  icons.

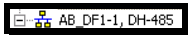

- 4 When you have verified that the driver is not being browsed, go to **COMMUNICATIONS>CONFIGURE DRIVERS**  
You may see something like this:

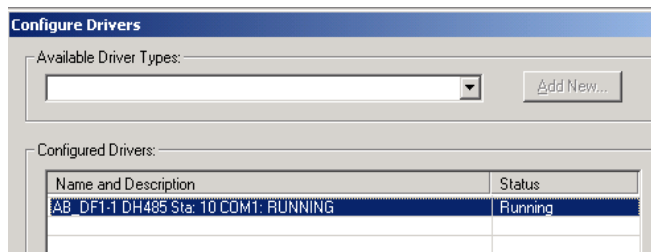

If you see the status as running, you will not be able to use this com port for anything other than communication to the processor. To stop the driver press the **STOP** button on the side of the window:

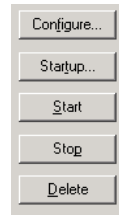

5 After you have stopped the driver you will see the following:

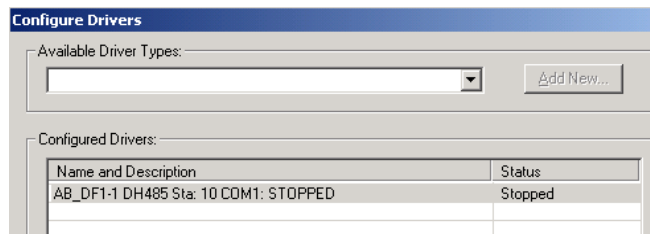

6 You may now use the com port to connect to the debug port of the module.

**Note:** You may need to shut down and restart your PC before it will allow you to stop the driver (usually only on *Windows NT* machines). If you have followed all of the above steps, and it will not stop the driver, then make sure you do not have *RSLogix* open. If *RSLogix* is not open, and you still cannot stop the driver, then reboot your PC.

### 5.3.3 DB9 to RJ45 Adaptor (Cable 14)

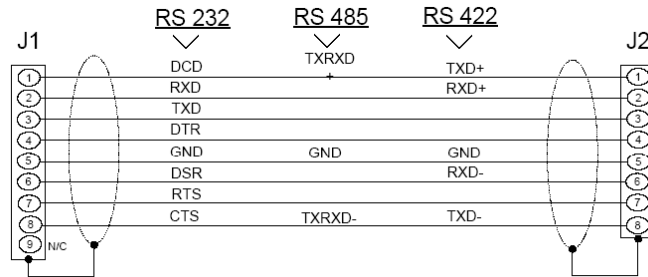
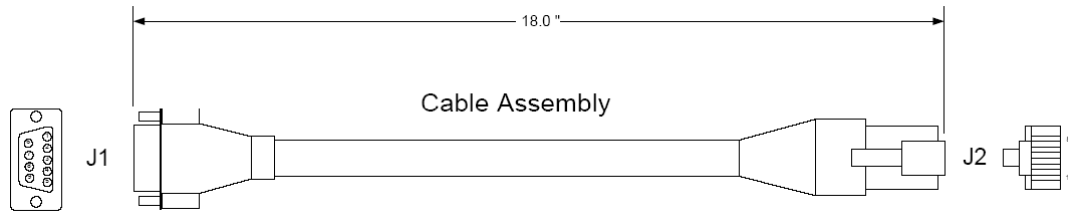

Wiring Diagram

## 5.4 MVI69-GEC Status Data For Block Transfer

If word 1 of the Input Image block is set to -1, the data for the first three servers, the product and block transfer data is sent in the block. The format of this block is as follows:

Parameter	Block Offset Start	Description
Seq Number	0	Sequence number for this block.
Server Index	1	For this status data block, this word is set to a value of -1.
PassCnt	2	Program cycle counter
Product	3	Product name as ASCII string
Rev	5	Revision level as ASCII string
OP	7	Operating system level as ASCII string
Run	9	Run number as ASCII string
BlkErrs.Read	11	Number of blocks transferred from module to processor
BlkErrs.Write	12	Number of blocks transferred from processor to module
BlkErrs.Parse	13	Number of blocks parsed by module
BlkErrs.Err	14	Number of block errors in module
Server[0].Enabled	15	This flag defines if the server is utilized. A value of 0 indicates the server is not used. Any other value indicates the server is used.
Server[0].State	16	This flag defines the current state of the server.
Server[0].IP	17	This double-word value contains the IP address of the client connected to the server.
Server[0].Port	19	This word value contains the port address for the client connected to the server.
Server[0].Open	20	This status value contains the total number of times the server performed an open operation.
Server[0].Established	21	This status value contains the total number of times a connection was established on the socket.
Server[0].Closed	22	This status value contains the total number of times a close operation was performed on the socket.
Server[0].RxCount	23	This status value contains the total number of messages received by the server.
Server[0].RxOverflow	24	This status value contains the total number of messages received that exceed the specified buffer size for the server.
Server[0].TxCount	25	This status value contains the total number of messages transmitted by the server.
Server[0].TxOverflow	26	This status value contains the total number of transmit messages that exceeded the specified maximum buffer size for the server.
Server[0].Timeout	27	This status value contains the total number of times a connection timeout occurred on the socket.
Server[0].CfgErrWord	28	This bit mapped word defines the configuration errors for the server.
Server[1].Enabled	29	This flag defines if the server is utilized. A value of 0 indicates the server is not used. Any other value indicates the server is used.
Server[1].State	30	This flag defines the current state of the server.

<b>Parameter</b>	<b>Block Offset Start</b>	<b>Description</b>
Server[1].IP	31	This double-word value contains the IP address of the client connected to the server.
Server[1].Port	33	This word value contains the port address for the client connected to the server.
Server[1].Open	34	This status value contains the total number of times the server performed an open operation.
Server[1].Established	35	This status value contains the total number of times a connection was established on the socket.
Server[1].Closed	36	This status value contains the total number of times a close operation was performed on the socket.
Server[1].RxCount	37	This status value contains the total number of messages received by the server.
Server[1].RxOverflow	38	This status value contains the total number of messages received that exceed the specified buffer size for the server.
Server[1].TxCount	39	This status value contains the total number of messages transmitted by the server.
Server[1].TxOverflow	40	This status value contains the total number of transmit messages that exceeded the specified maximum buffer size for the server.
Server[1].Timeout	41	This status value contains the total number of times a connection timeout occurred on the socket.
Server[1].CfgErrWord	42	This bit mapped word defines the configuration errors for the server.
Server[2].Enabled	43	This flag defines if the server is utilized. A value of 0 indicates the server is not used. Any other value indicates the server is used.
Server[2].State	44	This flag defines the current state of the server.
Server[2].IP	45	This double-word value contains the IP address of the client connected to the server.
Server[2].Port	47	This word value contains the port address for the client connected to the server.
Server[2].Open	48	This status value contains the total number of times the server performed an open operation.
Server[2].Established	49	This status value contains the total number of times a connection was established on the socket.
Server[2].Closed	50	This status value contains the total number of times a close operation was performed on the socket.
Server[2].RxCount	51	This status value contains the total number of messages received by the server.
Server[2].RxOverflow	52	This status value contains the total number of messages received that exceed the specified buffer size for the server.
Server[2].TxCount	53	This status value contains the total number of messages transmitted by the server.
Server[2].TxOverflow	54	This status value contains the total number of transmit messages that exceeded the specified maximum buffer size for the server.
Server[2].Timeout	55	This status value contains the total number of times a connection timeout occurred on the socket.
Server[2].CfgErrWord	56	This bit mapped word defines the configuration errors for the server.

Parameter	Block Offset Start	Description
Reserved	57	This data area is reserved for future use.
Server States	58 to 62	State of each of the five servers.
Last Write Count	63	This word contains the number of characters written on server from last BTR block.

If word 1 of the Input Image block is set to -2, the data for the last two servers is passed to the processor. The format of this block is as follows:

Parameter	Block Offset Start	Description
Seq Number	0	Sequence number for this block.
Server Index	1	For this status data block, this word is set to a value of -2.
PassCnt	2	Program cycle counter
Product	3	Product name as ASCII string
Rev	5	Revision level as ASCII string
OP	7	Operating system level as ASCII string
Run	9	Run number as ASCII string
BlkErrs.Read	11	Number of blocks transferred from module to processor
BlkErrs.Write	12	Number of blocks transferred from processor to module
BlkErrs.Parse	13	Number of blocks parsed by module
BlkErrs.Err	14	Number of block errors in module
Server[3].Enabled	15	This flag defines if the server is utilized. A value of 0 indicates the server is not used. Any other value indicates the server is used.
Server[3].State	16	This flag defines the current state of the server.
Server[3].IP	17	This double-word value contains the IP address of the client connected to the server.
Server[3].Port	19	This word value contains the port address for the client connected to the server.
Server[3].Open	20	This status value contains the total number of times the server performed an open operation.
Server[3].Established	21	This status value contains the total number of times a connection was established on the socket.
Server[3].Closed	22	This status value contains the total number of times a close operation was performed on the socket.
Server[3].RxCount	23	This status value contains the total number of messages received by the server.
Server[3].RxOverflow	24	This status value contains the total number of messages received that exceed the specified buffer size for the server.
Server[3].TxCount	25	This status value contains the total number of messages transmitted by the server.
Server[3].TxOverflow	26	This status value contains the total number of transmit messages that exceeded the specified maximum buffer size for the server.
Server[3].Timeout	27	This status value contains the total number of times a connection timeout occurred on the socket.

Parameter	Block Offset Start	Description
Server[3].CfgErrWord	28	This bit mapped word defines the configuration errors for the server.
Server[4].Enabled	29	This flag defines if the server is utilized. A value of 0 indicates the server is not used. Any other value indicates the server is used.
Server[4].State	30	This flag defines the current state of the server.
Server[4].IP	31	This double-word value contains the IP address of the client connected to the server.
Server[4].Port	33	This word value contains the port address for the client connected to the server.
Server[4].Open	34	This status value contains the total number of times the server performed an open operation.
Server[4].Established	35	This status value contains the total number of times a connection was established on the socket.
Server[4].Closed	36	This status value contains the total number of times a close operation was performed on the socket.
Server[4].RxCount	37	This status value contains the total number of messages received by the server.
Server[4].RxOverflow	38	This status value contains the total number of messages received that exceed the specified buffer size for the server.
Server[4].TxCount	39	This status value contains the total number of messages transmitted by the server.
Server[4].TxOverflow	40	This status value contains the total number of transmit messages that exceeded the specified maximum buffer size for the server.
Server[4].Timeout	41	This status value contains the total number of times a connection timeout occurred on the socket.
Server[4].CfgErrWord	42	This bit mapped word defines the configuration errors for the server.
Reserved	43 to 57	This data area is reserved for future use.
Server States	58 to 62	State of each of the five servers.
Last Write Count	63	This word contains the number of characters written on server from last BTR block.

If word 1 of the Input Image block is set to -3, the data for the first three clients is passed to the processor. The format of this block is as follows:

Parameter	Block Offset Start	Description
Seq Number	0	Sequence number for this block.
Server Index	1	For this status data block, this word is set to a value of -3.
PassCnt	2	Program cycle counter
Product	3	Product name as ASCII string
Rev	5	Revision level as ASCII string
OP	7	Operating system level as ASCII string
Run	9	Run number as ASCII string
BlkErrs.Read	11	Number of blocks transferred from module to processor
BlkErrs.Write	12	Number of blocks transferred from processor to module

<b>Parameter</b>	<b>Block Offset Start</b>	<b>Description</b>
BlkErrs.Parse	13	Number of blocks parsed by module
BlkErrs.Err	14	Number of block errors in module
Client[0].Connected	15	This flag defines if the client is utilized and connected to a server. A value of 0 indicates the client is not connected and can be utilized for a connection. Any other value indicates the client is connected and being used.
Client[0].State	16	This flag defines the current state of the client.
Client[0].IP	17	This double-word value contains the IP address of the server connected to the client.
Client[0].Port	19	This word value contains the port address for the server connected to the client.
Client[0].RxCount	20	This status value contains the total number of messages received by the client.
Client[0].RxOverflow	21	This status value contains the total number of messages received that exceed the specified buffer size for the client.
Client[0].TxCount	22	This status value contains the total number of messages transmitted by the client.
Client[0].TxOverflow	23	This status value contains the total number of transmit messages that exceeded the specified maximum buffer size for the client.
Client[0].spare	24	Reserved for future use
Client[1].Connected	25	This flag defines if the client is utilized and connected to a server. A value of 0 indicates the client is not connected and can be utilized for a connection. Any other value indicates the client is connected and being used.
Client[1].State	26	This flag defines the current state of the client.
Client[1].IP	27	This double-word value contains the IP address of the server connected to the client.
Client[1].Port	29	This word value contains the port address for the server connected to the client.
Client[1].RxCount	30	This status value contains the total number of messages received by the client.
Client[1].RxOverflow	31	This status value contains the total number of messages received that exceed the specified buffer size for the client.
Client[1].TxCount	32	This status value contains the total number of messages transmitted by the client.
Client[1].TxOverflow	33	This status value contains the total number of transmit messages that exceeded the specified maximum buffer size for the client.
Client[1].spare	34	Reserved for future use
Client[2].Connected	35	This flag defines if the client is utilized and connected to a server. A value of 0 indicates the client is not connected and can be utilized for a connection. Any other value indicates the client is connected and being used.
Client[2].State	36	This flag defines the current state of the client.
Client[2].IP	37	This double-word value contains the IP address of the server connected to the client.
Client[2].Port	39	This word value contains the port address for the server connected to the client.

Parameter	Block Offset Start	Description
Client[2].RxCount	40	This status value contains the total number of messages received by the client.
Client[2].RxOverflow	41	This status value contains the total number of messages received that exceed the specified buffer size for the client.
Client[2].TxCount	42	This status value contains the total number of messages transmitted by the client.
Client[2].TxOverflow	43	This status value contains the total number of transmit messages that exceeded the specified maximum buffer size for the client.
Client[2].spare	44	Reserved for future use
Reserved	45 to 57	This data area is reserved for future use.
Server States	58 to 62	State of each of the five servers.
Last Write Count	63	This word contains the number of characters written on server from last BTR block.

f word 1 of the Input Image block is set to -4, the data for the last two clients is passed to the processor. The format of this block is as follows:

Parameter	Block Offset Start	Description
Seq Number	0	Sequence number for this block.
Server Index	1	For this status data block, this word is set to a value of -4.
PassCnt	2	Program cycle counter
Product	3	Product name as ASCII string
Rev	5	Revision level as ASCII string
OP	7	Operating system level as ASCII string
Run	9	Run number as ASCII string
BlkErrs.Read	11	Number of blocks transferred from module to processor
BlkErrs.Write	12	Number of blocks transferred from processor to module
BlkErrs.Parse	13	Number of blocks parsed by module
BlkErrs.Err	14	Number of block errors in module
Client[3].Connected	15	This flag defines if the client is utilized and connected to a server. A value of 0 indicates the client is not connected and can be utilized for a connection. Any other value indicates the client is connected and being used.
Client[3].State	16	This flag defines the current state of the client.
Client[3].IP	17	This double-word value contains the IP address of the server connected to the client.
Client[3].Port	19	This word value contains the port address for the server connected to the client.
Client[3].RxCount	20	This status value contains the total number of messages received by the client.
Client[3].RxOverflow	21	This status value contains the total number of messages received that exceed the specified buffer size for the client.
Client[3].TxCount	22	This status value contains the total number of messages transmitted by the client.

<b>Parameter</b>	<b>Block Offset Start</b>	<b>Description</b>
Client[3].TxOverflow	23	This status value contains the total number of transmit messages that exceeded the specified maximum buffer size for the client.
Client[3].spare	24	Reserved for future use
Client[4].Connected	25	This flag defines if the client is utilized and connected to a server. A value of 0 indicates the client is not connected and can be utilized for a connection. Any other value indicates the client is connected and being used.
Client[4].State	26	This flag defines the current state of the client.
Client[4].IP	27	This double-word value contains the IP address of the server connected to the client.
Client[4].Port	29	This word value contains the port address for the server connected to the client.
Client[4].RxCount	30	This status value contains the total number of messages received by the client.
Client[4].RxOverflow	31	This status value contains the total number of messages received that exceed the specified buffer size for the client.
Client[4].TxCount	32	This status value contains the total number of messages transmitted by the client.
Client[4].TxOverflow	33	This status value contains the total number of transmit messages that exceeded the specified maximum buffer size for the client.
Client[4].spare	34	Reserved for future use
Reserved	35 to 57	This data area is reserved for future use.
Server States	58 to 62	State of each of the five servers.
Last Write Count	63	This word contains the number of characters written on server from last BTR block.



## 6 Support, Service & Warranty

### In This Chapter

- ❖ Contacting Technical Support ..... 91
- ❖ Return Material Authorization (RMA) Policies and Conditions..... 93
- ❖ LIMITED WARRANTY..... 95

### **Contacting Technical Support**

ProSoft Technology, Inc. (ProSoft) is committed to providing the most efficient and effective support possible. Before calling, please gather the following information to assist in expediting this process:

- 1 Product Version Number
- 2 System architecture
- 3 Network details

If the issue is hardware related, we will also need information regarding:

- 1 Module configuration and associated ladder files, if any
- 2 Module operation and any unusual behavior
- 3 Configuration/Debug status information
- 4 LED patterns
- 5 Details about the serial, Ethernet or fieldbus devices interfaced to the module, if any.

**Note:** For technical support calls within the United States, an after-hours answering system allows 24-hour/7-days-a-week pager access to one of our qualified Technical and/or Application Support Engineers.

---

<b>Internet</b>	Web Site: <a href="http://www.prosoft-technology.com/support">www.prosoft-technology.com/support</a> E-mail address: <a href="mailto:support@prosoft-technology.com">support@prosoft-technology.com</a>
<b>Asia Pacific</b> (location in Malaysia)	Tel: +603.7724.2080, E-mail: <a href="mailto:asiapc@prosoft-technology.com">asiapc@prosoft-technology.com</a> Languages spoken include: Chinese, English
<b>Asia Pacific</b> (location in China)	Tel: +86.21.5187.7337 x888, E-mail: <a href="mailto:asiapc@prosoft-technology.com">asiapc@prosoft-technology.com</a> Languages spoken include: Chinese, English
<b>Europe</b> (location in Toulouse, France)	Tel: +33 (0) 5.34.36.87.20, E-mail: <a href="mailto:support.EMEA@prosoft-technology.com">support.EMEA@prosoft-technology.com</a> Languages spoken include: French, English
<b>Europe</b> (location in Dubai, UAE)	Tel: +971-4-214-6911, E-mail: <a href="mailto:mea@prosoft-technology.com">mea@prosoft-technology.com</a> Languages spoken include: English, Hindi
<b>North America</b> (location in California)	Tel: +1.661.716.5100, E-mail: <a href="mailto:support@prosoft-technology.com">support@prosoft-technology.com</a> Languages spoken include: English, Spanish
<b>Latin America</b> (Oficina Regional)	Tel: +1-281-2989109, E-Mail: <a href="mailto:latinam@prosoft-technology.com">latinam@prosoft-technology.com</a> Languages spoken include: Spanish, English
<b>Latin America</b> (location in Puebla, Mexico)	Tel: +52-222-3-99-6565, E-mail: <a href="mailto:soporte@prosoft-technology.com">soporte@prosoft-technology.com</a> Languages spoken include: Spanish
<b>Brasil</b> (location in Sao Paulo)	Tel: +55-11-5083-3776, E-mail: <a href="mailto:brasil@prosoft-technology.com">brasil@prosoft-technology.com</a> Languages spoken include: Portuguese, English

---

## 6.1 Return Material Authorization (RMA) Policies and Conditions

The following Return Material Authorization (RMA) Policies and Conditions (collectively, "RMA Policies") apply to any returned product. These RMA Policies are subject to change by ProSoft Technology, Inc., without notice. For warranty information, see Limited Warranty (page 95). In the event of any inconsistency between the RMA Policies and the Warranty, the Warranty shall govern.

### 6.1.1 Returning Any Product

- a) In order to return a Product for repair, exchange, or otherwise, the Customer must obtain a Return Material Authorization (RMA) number from ProSoft Technology and comply with ProSoft Technology shipping instructions.
- b) In the event that the Customer experiences a problem with the Product for any reason, Customer should contact ProSoft Technical Support at one of the telephone numbers listed above (page 91). A Technical Support Engineer will request that you perform several tests in an attempt to isolate the problem. If after completing these tests, the Product is found to be the source of the problem, we will issue an RMA.
- c) All returned Products must be shipped freight prepaid, in the original shipping container or equivalent, to the location specified by ProSoft Technology, and be accompanied by proof of purchase and receipt date. The RMA number is to be prominently marked on the outside of the shipping box. Customer agrees to insure the Product or assume the risk of loss or damage in transit. Products shipped to ProSoft Technology using a shipment method other than that specified by ProSoft Technology, or shipped without an RMA number will be returned to the Customer, freight collect. Contact ProSoft Technical Support for further information.
- d) A 10% restocking fee applies to all warranty credit returns, whereby a Customer has an application change, ordered too many, does not need, etc. Returns for credit require that all accessory parts included in the original box (i.e.; antennas, cables) be returned. Failure to return these items will result in a deduction from the total credit due for each missing item.

### **6.1.2 Returning Units Under Warranty**

A Technical Support Engineer must approve the return of Product under ProSoft Technology's Warranty:

- a) A replacement module will be shipped and invoiced. A purchase order will be required.
- b) Credit for a product under warranty will be issued upon receipt of authorized product by ProSoft Technology at designated location referenced on the Return Material Authorization
  - i. If a defect is found and is determined to be customer generated, or if the defect is otherwise not covered by ProSoft Technology's warranty, there will be no credit given. Customer will be contacted and can request module be returned at their expense;
  - ii. If defect is customer generated and is repairable, customer can authorize ProSoft Technology to repair the unit by providing a purchase order for 30% of the current list price plus freight charges, duties and taxes as applicable.

### **6.1.3 Returning Units Out of Warranty**

- a) Customer sends unit in for evaluation to location specified by ProSoft Technology, freight prepaid.
- b) If no defect is found, Customer will be charged the equivalent of \$100 USD, plus freight charges, duties and taxes as applicable. A new purchase order will be required.
- c) If unit is repaired, charge to Customer will be 30% of current list price (USD) plus freight charges, duties and taxes as applicable. A new purchase order will be required or authorization to use the purchase order submitted for evaluation fee.

**The following is a list of non-repairable units:**

- 3150 - All
- 3750
- 3600 - All
- 3700
- 3170 - All
- 3250
- 1560 - Can be repaired, only if defect is the power supply
- 1550 - Can be repaired, only if defect is the power supply
- 3350
- 3300
- 1500 - All

## 6.2 LIMITED WARRANTY

This Limited Warranty ("Warranty") governs all sales of hardware, software, and other products (collectively, "Product") manufactured and/or offered for sale by ProSoft Technology, Incorporated (ProSoft), and all related services provided by ProSoft, including maintenance, repair, warranty exchange, and service programs (collectively, "Services"). By purchasing or using the Product or Services, the individual or entity purchasing or using the Product or Services ("Customer") agrees to all of the terms and provisions (collectively, the "Terms") of this Limited Warranty. All sales of software or other intellectual property are, in addition, subject to any license agreement accompanying such software or other intellectual property.

### 6.2.1 What Is Covered By This Warranty

- a) *Warranty On New Products:* ProSoft warrants, to the original purchaser, that the Product that is the subject of the sale will (1) conform to and perform in accordance with published specifications prepared, approved and issued by ProSoft, and (2) will be free from defects in material or workmanship; provided these warranties only cover Product that is sold as new. This Warranty expires three (3) years from the date of shipment for Product purchased **on or after** January 1st, 2008, or one (1) year from the date of shipment for Product purchased **before** January 1st, 2008 (the "Warranty Period"). If the Customer discovers within the Warranty Period a failure of the Product to conform to specifications, or a defect in material or workmanship of the Product, the Customer must promptly notify ProSoft by fax, email or telephone. In no event may that notification be received by ProSoft later than 39 months from date of original shipment. Within a reasonable time after notification, ProSoft will correct any failure of the Product to conform to specifications or any defect in material or workmanship of the Product, with either new or remanufactured replacement parts. ProSoft reserves the right, and at its sole discretion, may replace unrepairable units with new or remanufactured equipment. All replacement units will be covered under warranty for the 3 year period commencing from the date of original equipment purchase, not the date of shipment of the replacement unit. Such repair, including both parts and labor, will be performed at ProSoft's expense. All warranty service will be performed at service centers designated by ProSoft.
- b) *Warranty On Services:* Materials and labor performed by ProSoft to repair a verified malfunction or defect are warranted in the terms specified above for new Product, provided said warranty will be for the period remaining on the original new equipment warranty or, if the original warranty is no longer in effect, for a period of 90 days from the date of repair.

### **6.2.2 What Is Not Covered By This Warranty**

- a) ProSoft makes no representation or warranty, expressed or implied, that the operation of software purchased from ProSoft will be uninterrupted or error free or that the functions contained in the software will meet or satisfy the purchaser's intended use or requirements; the Customer assumes complete responsibility for decisions made or actions taken based on information obtained using ProSoft software.
- b) This Warranty does not cover the failure of the Product to perform specified functions, or any other non-conformance, defects, losses or damages caused by or attributable to any of the following: (i) shipping; (ii) improper installation or other failure of Customer to adhere to ProSoft's specifications or instructions; (iii) unauthorized repair or maintenance; (iv) attachments, equipment, options, parts, software, or user-created programming (including, but not limited to, programs developed with any IEC 61131-3, "C" or any variant of "C" programming languages) not furnished by ProSoft; (v) use of the Product for purposes other than those for which it was designed; (vi) any other abuse, misapplication, neglect or misuse by the Customer; (vii) accident, improper testing or causes external to the Product such as, but not limited to, exposure to extremes of temperature or humidity, power failure or power surges; or (viii) disasters such as fire, flood, earthquake, wind and lightning.
- c) The information in this Agreement is subject to change without notice. ProSoft shall not be liable for technical or editorial errors or omissions made herein; nor for incidental or consequential damages resulting from the furnishing, performance or use of this material. The user guide included with your original product purchase from ProSoft contains information protected by copyright. No part of the guide may be duplicated or reproduced in any form without prior written consent from ProSoft.

### **6.2.3 Disclaimer Regarding High Risk Activities**

Product manufactured or supplied by ProSoft is not fault tolerant and is not designed, manufactured or intended for use in hazardous environments requiring fail-safe performance including and without limitation: the operation of nuclear facilities, aircraft navigation or communication systems, air traffic control, direct life support machines or weapons systems in which the failure of the product could lead directly or indirectly to death, personal injury or severe physical or environmental damage (collectively, "high risk activities"). ProSoft specifically disclaims any express or implied warranty of fitness for high risk activities.

#### **6.2.4 Intellectual Property Indemnity**

Buyer shall indemnify and hold harmless ProSoft and its employees from and against all liabilities, losses, claims, costs and expenses (including attorney's fees and expenses) related to any claim, investigation, litigation or proceeding (whether or not ProSoft is a party) which arises or is alleged to arise from Buyer's acts or omissions under these Terms or in any way with respect to the Products. Without limiting the foregoing, Buyer (at its own expense) shall indemnify and hold harmless ProSoft and defend or settle any action brought against such Companies to the extent based on a claim that any Product made to Buyer specifications infringed intellectual property rights of another party. ProSoft makes no warranty that the product is or will be delivered free of any person's claiming of patent, trademark, or similar infringement. The Buyer assumes all risks (including the risk of suit) that the product or any use of the product will infringe existing or subsequently issued patents, trademarks, or copyrights.

- a) Any documentation included with Product purchased from ProSoft is protected by copyright and may not be duplicated or reproduced in any form without prior written consent from ProSoft.
- b) ProSoft's technical specifications and documentation that are included with the Product are subject to editing and modification without notice.
- c) Transfer of title shall not operate to convey to Customer any right to make, or have made, any Product supplied by ProSoft.
- d) Customer is granted no right or license to use any software or other intellectual property in any manner or for any purpose not expressly permitted by any license agreement accompanying such software or other intellectual property.
- e) Customer agrees that it shall not, and shall not authorize others to, copy software provided by ProSoft (except as expressly permitted in any license agreement accompanying such software); transfer software to a third party separately from the Product; modify, alter, translate, decode, decompile, disassemble, reverse-engineer or otherwise attempt to derive the source code of the software or create derivative works based on the software; export the software or underlying technology in contravention of applicable US and international export laws and regulations; or use the software other than as authorized in connection with use of Product.
- f) **Additional Restrictions Relating To Software And Other Intellectual Property**

In addition to compliance with the Terms of this Warranty, Customers purchasing software or other intellectual property shall comply with any license agreement accompanying such software or other intellectual property. Failure to do so may void this Warranty with respect to such software and/or other intellectual property.

#### **6.2.5 Disclaimer of all Other Warranties**

The Warranty set forth in What Is Covered By This Warranty (page 95) are in lieu of all other warranties, express or implied, including but not limited to the implied warranties of merchantability and fitness for a particular purpose.

### **6.2.6 Limitation of Remedies \*\***

In no event will ProSoft or its Dealer be liable for any special, incidental or consequential damages based on breach of warranty, breach of contract, negligence, strict tort or any other legal theory. Damages that ProSoft or its Dealer will not be responsible for include, but are not limited to: Loss of profits; loss of savings or revenue; loss of use of the product or any associated equipment; loss of data; cost of capital; cost of any substitute equipment, facilities, or services; downtime; the claims of third parties including, customers of the Purchaser; and, injury to property.

\*\* Some areas do not allow time limitations on an implied warranty, or allow the exclusion or limitation of incidental or consequential damages. In such areas, the above limitations may not apply. This Warranty gives you specific legal rights, and you may also have other rights which vary from place to place.

### **6.2.7 Time Limit for Bringing Suit**

Any action for breach of warranty must be commenced within 39 months following shipment of the Product.

### **6.2.8 No Other Warranties**

Unless modified in writing and signed by both parties, this Warranty is understood to be the complete and exclusive agreement between the parties, suspending all oral or written prior agreements and all other communications between the parties relating to the subject matter of this Warranty, including statements made by salesperson. No employee of ProSoft or any other party is authorized to make any warranty in addition to those made in this Warranty. The Customer is warned, therefore, to check this Warranty carefully to see that it correctly reflects those terms that are important to the Customer.

### **6.2.9 Allocation of Risks**

This Warranty allocates the risk of product failure between ProSoft and the Customer. This allocation is recognized by both parties and is reflected in the price of the goods. The Customer acknowledges that it has read this Warranty, understands it, and is bound by its Terms.

### ***6.2.10 Controlling Law and Severability***

This Warranty shall be governed by and construed in accordance with the laws of the United States and the domestic laws of the State of California, without reference to its conflicts of law provisions. If for any reason a court of competent jurisdiction finds any provisions of this Warranty, or a portion thereof, to be unenforceable, that provision shall be enforced to the maximum extent permissible and the remainder of this Warranty shall remain in full force and effect. Any cause of action with respect to the Product or Services must be instituted in a court of competent jurisdiction in the State of California.



## Index

### I

[Module] • 27  
[Server x] • 28

### A

Adding the Module to an Existing CompactLogix Project • 41, 43  
Adding the Module to an Existing MicroLogix Project • 41, 43  
Allocation of Risks • 98

### B

Backplane Data Transfer • 64  
Battery Life Advisory • 3

### C

Cable Connections • 78  
Clearing a Fault Condition • 47  
Configuring Module Parameters • 26  
Configuring the MVI69-GEC Module • 23  
Configuring the RSLinx Driver for the PC COM Port • 19  
Connecting Your PC to the Module • 21  
Connecting Your PC to the Processor • 17  
Connection Close Type • 28  
Connection Timeout • 28  
Contacting Technical Support • 91, 93  
Controlling Law and Severability • 99

### D

DB9 to RJ45 Adaptor (Cable 14) • 82  
Diagnostics and Troubleshooting • 7, 44, 45, 79  
Disabling the RSLinx Driver for the Com Port on the PC • 80  
Disclaimer of all Other Warranties • 97  
Disclaimer Regarding High Risk Activities • 96  
Downloading the Project to the Module Using a Serial COM port • 31  
Downloading the Sample Program to the Processor • 18, 42, 44

### E

Enabled • 28  
Ethernet Configuration • 30  
Ethernet Connection • 78  
Ethernet LED Indicators • 46  
Ethernet Port Configuration - wattcp.cfg • 79  
Exiting the Program • 55

### F

Functional Overview • 7, 63  
Functional Specifications - MVI69-GEC • 62

### G

GECBackplane (Backplane Object) • 40  
GECBlkStat (Block Error Status Object) • 38  
GECClientStat • 39  
GECInStat (Status Object) • 37  
GECServerStat (Server Status Object) • 38  
General Concepts • 63  
General Specifications • 60  
Guide to the MVI69-GEC User Manual • 7

### H

Handling Multiple Blocks • 75  
Hardware Specifications • 61  
How to Contact Us • 2

### I

Important Installation Instructions • 3  
Installing ProSoft Configuration Builder Software • 12  
Installing the Module in the Rack • 14  
Intellectual Property Indemnity • 97

### K

Keystrokes • 51

### L

Ladder Logic • 33  
LED Status Indicators • 46  
Limitation of Remedies \*\* • 98  
LIMITED WARRANTY • 93, 95

### M

Main Logic Loop • 63  
Main Menu • 52  
Markings • 4  
Module Data • 34  
Module Name • 27  
Module Power Up • 63  
MVI (Multi Vendor Interface) Modules • 3  
MVI69-GEC Status Data For Block Transfer • 83

### N

Navigation • 51  
Network Data Transfer • 75  
Network Menu • 54, 55  
No Other Warranties • 98  
Normal Data Transfer • 65

### O

Opening the Network Menu • 54

## P

Package Contents • 11  
Pinouts • 3, 78, 82  
Printing a Configuration File • 26  
Product Specifications • 7, 60  
ProSoft Technology® Product Documentation • 2

## R

Read Block • 65  
Reading Status Data from the Module • 57  
Redisplaying the Menu • 52  
Reference • 7, 59  
Renaming PCB Objects • 26  
Resetting Diagnostic Data • 53  
Return Material Authorization (RMA) Policies and Conditions • 93  
Returning Any Product • 93  
Returning to the Main Menu • 56  
Returning Units Out of Warranty • 94  
Returning Units Under Warranty • 94  
RS-232 Configuration/Debug Port • 79

## S

Service Port Number • 28  
Setting Jumpers • 13  
Setting Up the Project • 24  
Special Block  
    Structure of Client Connection Request Data • 74  
Start Here • 7, 9  
Support, Service & Warranty • 7, 91  
Swap Rx Data Bytes • 28  
Swap Tx Data Bytes • 29  
System Requirements • 10

## T

Time Limit for Bringing Suit • 98  
Transferring the Configuration File from The Module to the PC • 53  
Transferring the Configuration File from the PC to the Module • 53  
Transferring WATTCP.CFG to the Module • 55  
Transferring WATTCP.CFG to the PC • 55  
Troubleshooting • 48

## U

Using ProSoft Configuration Builder • 24  
Using ProSoft Configuration Builder (PCB) for Diagnostics • 49  
Using the Diagnostic Window in ProSoft Configuration Builder • 49

## V

Viewing Block Transfer Statistics • 52  
Viewing Client Communication Status (Clients 10 to 14) • 54  
Viewing Module Configuration • 52

Viewing Server Communication Status (Servers 0 to 4) • 54  
Viewing Server Configuration (Servers 0 to 4) • 54  
Viewing the WATTCP.CFG File on the module • 56  
Viewing Version Information • 53

## W

Warm Booting the Module • 53  
Warnings • 3  
What Is Covered By This Warranty • 95, 97  
What Is Not Covered By This Warranty • 96  
Write Block • 73

## Y

Your Feedback Please • 2