



Where Automation Connects.

PLX82-MNET-61850

Communication Gateway

Modbus TCP/IP to IEC 61850 Gateway



October 14, 2024

USER MANUAL

Your Feedback Please

We always want you to feel that you made the right decision to use our products. If you have suggestions, comments, compliments or complaints about our products, documentation, or support, please write or call us.

How to Contact Us

ProSoft Technology, Inc.
+1 (661) 716-5100
+1 (661) 716-5101 (Fax)
www.prosoft-technology.com
support@prosoft-technology.com

PLX82-MNET-61850 User Manual
For Public Use.

October 14, 2024

ProSoft Technology®, is a registered copyright of ProSoft Technology, Inc. All other brand or product names are or may be trademarks of, and are used to identify products and services of, their respective owners.

Content Disclaimer

This documentation is not intended as a substitute for and is not to be used for determining suitability or reliability of these products for specific user applications. It is the duty of any such user or integrator to perform the appropriate and complete risk analysis, evaluation and testing of the products with respect to the relevant specific application or use thereof. Neither ProSoft Technology nor any of its affiliates or subsidiaries shall be responsible or liable for misuse of the information contained herein. Information in this document including illustrations, specifications and dimensions may contain technical inaccuracies or typographical errors. ProSoft Technology makes no warranty or representation as to its accuracy and assumes no liability for and reserves the right to correct such inaccuracies or errors at any time without notice. If you have any suggestions for improvements or amendments or have found errors in this publication, please notify us.

No part of this document may be reproduced in any form or by any means, electronic or mechanical, including photocopying, without express written permission of ProSoft Technology. All pertinent state, regional, and local safety regulations must be observed when installing and using this product. For reasons of safety and to help ensure compliance with documented system data, only the manufacturer should perform repairs to components. When devices are used for applications with technical safety requirements, the relevant instructions must be followed. Failure to use ProSoft Technology software or approved software with our hardware products may result in injury, harm, or improper operating results. Failure to observe this information can result in injury or equipment damage.

Copyright © 2024 ProSoft Technology, Inc. All Rights Reserved.

Important Safety Information

Important Installation Instructions

Power, Input, and Output (I/O) wiring must be in accordance with Class I, Division 2 wiring methods, Article 501-4 (b) of the National Electrical Code, NFPA 70 for installation in the U.S., or as specified in Section 18-1J2 of the Canadian Electrical Code for installations in Canada, and in accordance with the authority having jurisdiction. The following warnings must be heeded:

WARNING - EXPLOSION HAZARD - SUBSTITUTION OF COMPONENTS MAY IMPAIR SUITABILITY FOR CLASS I, DIV. 2;

WARNING - EXPLOSION HAZARD - WHEN IN HAZARDOUS LOCATIONS, TURN OFF POWER BEFORE REPLACING OR WIRING MODULES

WARNING - EXPLOSION HAZARD - DO NOT DISCONNECT EQUIPMENT UNLESS POWER HAS BEEN SWITCHED OFF OR THE AREA IS KNOWN TO BE NON-HAZARDOUS.
THIS DEVICE SHALL BE POWERED BY CLASS 2 OUTPUTS ONLY.

Product Warnings

WARNING – EXPLOSION HAZARD – DO NOT DISCONNECT EQUIPMENT UNLESS POWER HAS BEEN SWITCHED OFF OR THE AREA IS KNOWN TO BE NON-HAZARDOUS.

AVERTISSEMENT – RISQUE D'EXPLOSION – AVANT DE DÉCONNECTER L'EQUIPMENT, COUPER LE COURANT OU S'ASSURER QUE L'EMPLACEMENT EST DÉSIGNÉ NON DANGEREUX.



For professional users in the European Union

If you wish to discard electrical and electronic equipment (EEE), please contact your dealer or supplier for further information.



Warning – Cancer and Reproductive Harm – www.P65Warnings.ca.gov

Agency Approvals and Certifications

Please visit our website: www.prosoft-technology.com

Contents

Your Feedback Please	2
How to Contact Us.....	2
Content Disclaimer	2
Important Safety Information	3
1 Start Here	7
1.1 Overview	7
1.2 System Requirements	8
1.3 Deployment Checklist	8
1.4 Package Contents	8
1.5 Jumper Setting.....	9
1.6 Mounting the PLX82-MNET-61850 on a DIN-rail	10
1.7 Connecting Power to the Unit.....	11
1.8 Installing ProSoft Software	12
1.8.1 Installing the ProSoft Discovery Service.....	12
1.8.2 Installing the ProSoft MNET-61850 Configuration Manager	12
1.8.3 Installing the ProSoft MNET-61850 Tag Monitor	12
2 Configuring the PLX82-MNET-61850 Gateway	13
2.1 Connecting Your PC to the Gateway.....	13
2.2 Setting a Temporary IP Address in the Gateway	13
2.3 Creating a New Project in the Configuration Manager	15
2.4 Importing a Project into the Configuration Manager	17
2.5 Ethernet Port Configurations	17
3 61850 Configuration	20
3.1 Importing IED Files	20
3.2 Creating the IED Network	23
3.3 Mapping Data Attributes from IEDs to the Gateway.....	24
3.3.1 Mapping MMS Messages	25
3.3.2 Mapping MMS Write Messages.....	28
3.3.3 Mapping Reports	29
3.3.4 Mapping GOOSE Messages	32
3.3.5 GOOSE Message Assumptions	34
3.3.6 Deleting One or More IEC 61850 Mappings.....	35
4 Modbus TCP/IP Configuration	36
4.1 Adding Modbus TCP/IP Devices	36
4.2 Mapping Data Attributes Modbus TCP/IP	37
4.3 Setting Modbus TCP/IP Port Properties	39
4.4 Configuring Modbus TCP/IP Commands for a Device	41
4.4.1 Modbus TCP/IP Client Commands Overview.....	41
4.4.2 Modbus TCP/IP Commands	42
4.4.3 Viewing the Modbus Commands for a Device.....	44
4.4.4 Exporting Modbus Commands for a Device	46

4.5	Viewing Modbus TCP/IP Server Mapping	47
4.6	Viewing Modbus TCP/IP Client Mapping	48
5	Configuration File Management	49
5.1	Validating the Configuration.....	49
5.2	Downloading the Configuration File to the Gateway	50
5.3	Uploading the Configuration from the Gateway.....	51
5.4	Exporting a Project from the Configuration Manager	51
5.5	Importing Updated IED Files.....	52
6	Configuring the Quantum Processor with Unity Pro	54
6.1	Configuring the Quantum Hardware	54
6.1.1	Create a new Unity Pro Project	54
6.1.2	Adding a Power Supply	55
6.2	Importing the Quantum Functional Module (.XFM File)	57
6.3	Importing the Quantum Variable File (.XSY File)	59
6.4	Completing the Quantum Configuration	62
6.5	Verifying the Data Transfer	63
7	Diagnostics and Troubleshooting	64
7.1	Known Anomalies	64
7.2	Important Design Considerations	64
7.3	LEDs	65
7.4	Driver Status Data	66
7.5	Rebooting the Gateway	66
7.6	ProSoft EIP-61850 Tag Monitor Diagnostics.....	67
7.7	ProSoft 61850 Configuration Manager Diagnostics	68
7.7.1	IEC 61850 Client Diagnostics	68
7.7.2	MCP Diagnostics	73
7.7.3	Modbus TCP/IP Diagnostics.....	75
7.7.4	SNTP/NTP	80
7.8	Web Service and Gateway Web Page	81
7.9	Event Logger.....	83
7.9.1	61850C Events	84
7.9.2	MNET Events 1	85
7.9.3	MNET Events 2.....	86
7.9.4	MCP Events	87
7.9.5	MCP Interface Events	87
7.9.6	SNTP/NTP Events	87
7.9.7	InterProcess Communication (IPC) Events	88
8	Reference	89
8.1	Specifications.....	89
8.1.1	PLX82-MNET-61850 Overview	89
8.1.2	Specifications - Modbus TCP/IP	90
8.1.3	Specifications - IEC 61850 Client	91
8.1.4	Specifications - SNTP/NTP Client	91
8.2	Hardware Specifications	92
8.3	PLX82-MNET-61850 Gateway	93

8.3.1	Asynchronous Processes	93
8.3.2	Tag Database	94
8.3.3	SNTP/NTP	95
8.4	IEC 61850 Detailed Specifications	96
8.4.1	Application Association Model	96
8.4.2	DATA-SET	99
8.4.3	Report Control Block.....	99
8.4.4	GOOSE Control Block	104
8.4.5	Control	106
8.4.6	MMS.....	110
8.4.7	Modbus TCP/IP Server.....	114
8.4.8	IEC 61850 Client.....	115
8.5	Processing the Commands.....	116
8.6	IEC 61850 Standard Introduction	116
8.6.1	Integrating the Substation	117
8.6.2	IEC 61850 Benefits	118
8.6.3	IEC 61850 Communication Features	118
8.6.4	SCL / Standardized Data Exchange.....	118
8.6.5	Additional Advantages to Substation Configuration Description Language (SCL)	119
8.6.6	Report Control Block BRCB (Clause 14).....	121
8.6.7	GSE (Clause 15).....	121
8.6.8	Control (Clause 17).....	121
8.6.9	Time and Time Synchronization (Clause 18)	127
8.6.10	Naming Conventions (Clause 19).....	128
8.7	Usage Examples.....	129
8.7.1	Schneider Electric PLC/PAC Device Configuration	129
8.7.2	Example: Energy Application.....	129
8.7.3	Example: Oil & Gas Application.....	130
8.7.4	Monitoring	130
8.7.5	Measuring and Metering	130
8.7.6	Supervision and Protection.....	131
9	List of Abbreviations	132
10	Glossary of Terms	149
11	Support, Service & Warranty	166
11.1	Contacting Technical Support.....	166
11.2	Warranty Information	166

1 Start Here

To get the most benefit from this User Manual, you should have the following skills:

- **Unity Pro software:** launch the program and configure the M340, Quantum, or Premium processor
- **Microsoft Windows:** install and launch programs, execute menu commands, navigate dialog boxes, and enter data
- **Hardware installation and wiring:** install the module, and safely connect MNET-61850 and M340, Quantum, or Premium devices to a power source and to the PLX82-MNET-61850 module's Ethernet port
- **Intelligent Electronic Device (IED):** have one or more IEDs and be familiar with the IED configuration software

1.1 Overview

This User Manual explains the features of the PLX82-MNET-61850 Modbus TCP/IP to IEC 61850 gateway. It guides you through configuring the gateway, showing how to map IEC 61850 Data Attributes between an Intelligent Electronic Device (IED), through the gateway, and a Rockwell Automation® Modicon® Quantum® PLC. Premium® PLC, or M340® PAC. The ProSoft MNET-61850 Configuration Manager software creates files to import into Unity™ Pro programming software, integrating the gateway into your system.

This User Manual provides examples of how to move IEC 61850 Data Attributes using IEC 61850 8.1 MMS messages. The PLC or PAC reads and writes data to the IED. The ProSoft gateway automatically pushes (writes) data from the IEDs to the M340, Quantum, or Premium, so the M340, Quantum, or Premium does not have to be programmed to read the IED's data.

IEDs generally come with their own configuration software, and a template IED Capability Description (ICD) file. The template file represents a device that is not configured. Once configured, the device makes a Configured IED Description (CID) file. Some devices can also make a System Configuration Description (SCD) file. Some IEDs generate an ICD file (rather than a CID file) for their configured file, so be sure to have the right file. You must have these files on hand before beginning this process.

For a complete list of features and supported functions of the PLX82-MNET-61850 gateway, refer to the IEC 61850 PICS Statement, which is available as a separate download at: www.prosoft-technology.com.

1.2 System Requirements

The ProSoft MNET-61850 Configuration Manager configuration software for the PLX82-MNET-61850 gateway requires the following minimum hardware and software components:

- Pentium® II 450 MHz minimum. Pentium III 733 MHz (or better) recommended
- 128 Mbytes of RAM minimum, 256 Mbytes of RAM recommended
- 100 Mbytes of free hard disk space (or more based on application requirements)

Supported operating systems:

- Microsoft Windows 10
- Microsoft Windows 7 Professional (32-or 64-bit)
- Microsoft Windows 2000 Professional with Service Pack 1, 2, or 3
- Microsoft Windows Server 2003

1.3 Deployment Checklist

Before you begin to configure the module, consider the following questions. Your answers will help you determine the scope of your project, and the configuration requirements for a successful deployment.

- Is the Schneider Electric Unity Pro software installed?
- Do you have the Intelligent Electronic Devices (IEDs) and their configuration files?

1.4 Package Contents

The following components are included with your PLX82-MNET-61850 gateway, and are all required for installation and configuration.

Important: Before beginning the installation, verify that all of the following items are present.

Qty.	Part Name	Part Number	Part Description
1	Modbus TCP/IP to IEC 61850 gateway	PLX82-MNET-61850	ProSoft communication gateway
1	Screwdriver	HRD250	Small, flat-bladed screwdriver
1	Power Connector	J180	3-wire DC power connector

If any of these components are missing, please contact ProSoft Technology Technical Support for replacement parts.

1.5 Jumper Setting

Jumper settings are located on the back of the module.

For security reasons, the Mode 1 and Mode 2 jumpers are not readily accessible. Under normal conditions, these two jumpers will not be needed. The following diagram illustrates the available Setup Jumper setting.



Setup Jumper:

Mode 3 is jumpered by default. It is only required for firmware updates. There is no reason to remove this jumper.

1.6 Mounting the PLX82-MNET-61850 on a DIN-rail

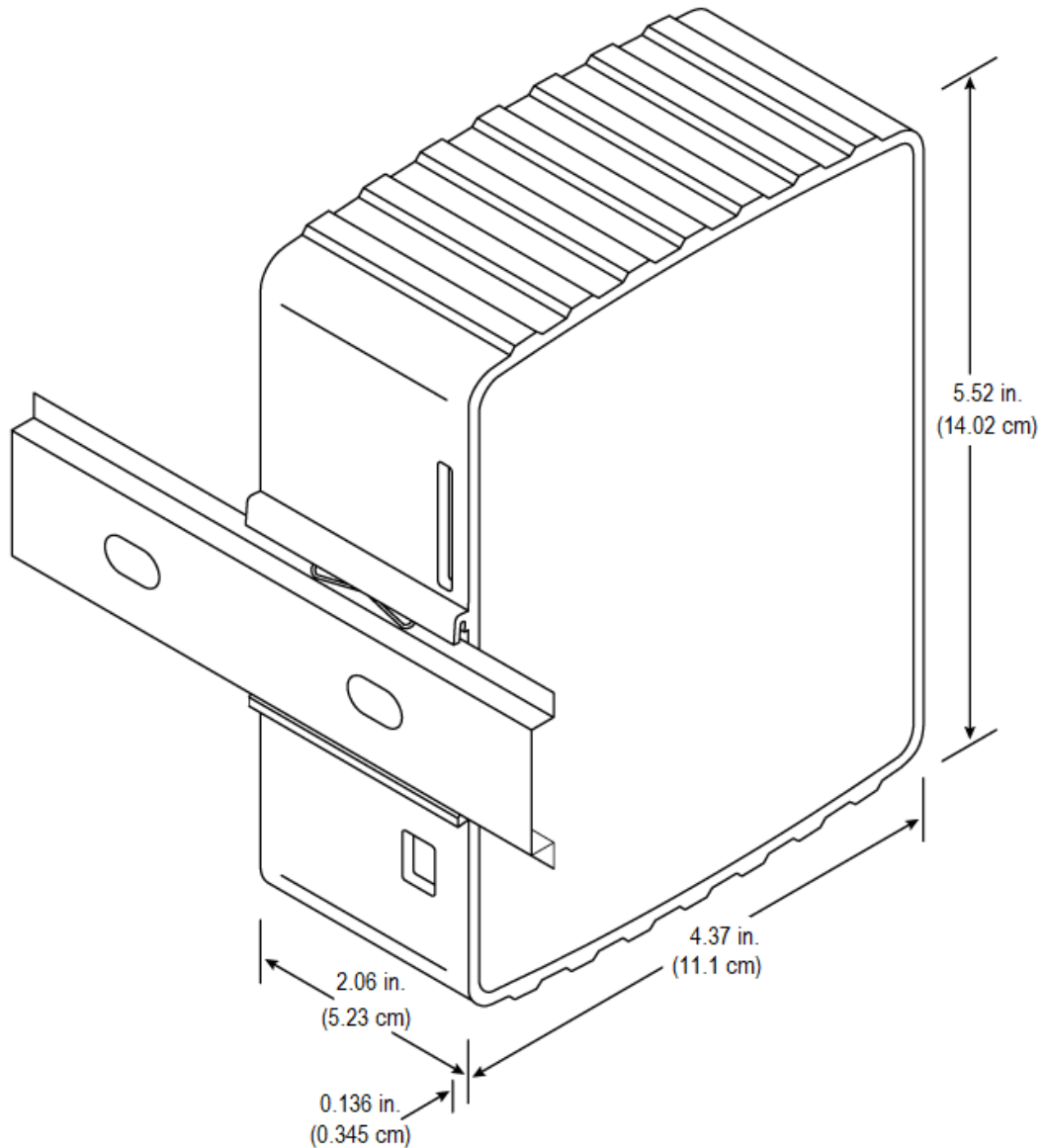

- 1 Position the PLX82-MNET-61850 on the DIN-rail B at a slight angle.
- 2 Hook the lip on the rear of the adapter onto the top of the DIN-rail, and rotate the adapter onto the rail.
- 3 Press the adapter down onto the DIN-rail until flush. The locking tab snaps into position and locks the module to the DIN-rail.
- 4 If the adapter does not lock in place, use a screwdriver or similar device to move the locking tab down while pressing the adapter flush onto the DIN-rail and release the locking tab to lock the adapter in place. If necessary, push up on the locking tab to lock.

1.7 Connecting Power to the Unit

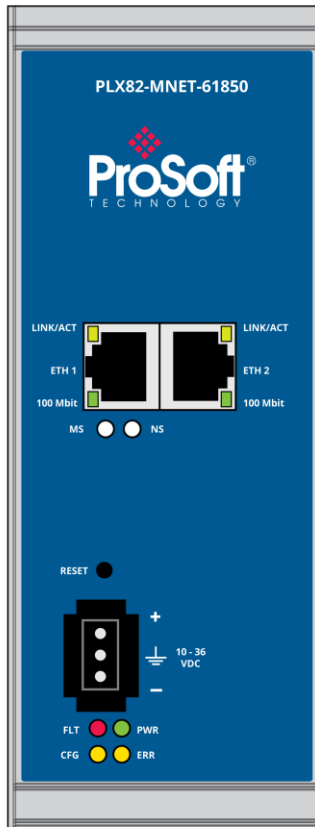

Symbol	Description
(+)	24 VDC (nominal) Range 10 to 36 VDC 500 mA max @ 24 VDC
Ground	Earth ground
(-)	Common VDC

1.8 Installing ProSoft Software

1.8.1 Installing the ProSoft Discovery Service

ProSoft Discovery Service (PDS) is a Windows-based software program that connects to the gateway through the Ethernet port for the following purposes:

- Automatically discovering the gateway on the Ethernet network.
- Setting a temporary IP address for the gateway for commissioning.
- Allowing PDS to select the gateway for monitoring and IP address reconfiguration.

This software is supplied as a stand-alone utility, available at:
www.prosoft-technology.com. To install the PDS, follow these steps:

- 1 Navigate to **PRODUCTS > PROSOFT SOFTWARE**.
- 2 Scroll through the list to locate ProSoft Discovery Service.
- 3 Choose **PROSOFT DISCOVERY SERVICE** to install.

1.8.2 Installing the ProSoft MNET-61850 Configuration Manager

Use the ProSoft MNET-61850 Configuration Manager to configure the gateway. You can find the ProSoft MNET-61850 Configuration Manager at:
www.prosoft-technology.com.

Important: Before installing the ProSoft MNET-61850 Configuration Manager, make sure your PC/laptop is updated with the latest Windows Updates.

- 1 Navigate to your PLX82-MNET-61850 product.
- 2 Choose **PROSOFT MNET-61850 CONFIGURATION MANAGER** to install.

Note: To use the ProSoft MNET-61850 Configuration Manager under the Windows 7 OS, you must be sure to install it using the *Run as Administrator* option. To find this option, right-click the **SETUP.EXE** program icon, and then click **RUN AS ADMINISTRATOR** on the context menu. (You must be logged in as an administrator on your network or PC). Using the *Run as Administrator* option allows the installation program to create folders and files on your PC with proper permissions and security.

If you do not use the Run as Administrator option, the ProSoft MNET-61850 Configuration Manager may appear to install correctly, but you will receive multiple file access errors whenever the ProSoft MNET-61850 Configuration Manager is running, especially when changing configuration screens. If this happens, you must completely uninstall the ProSoft MNET-61850 Configuration Manager and then re-install using the Run as Administrator option to eliminate the errors.

1.8.3 Installing the ProSoft MNET-61850 Tag Monitor

Use the ProSoft MNET-61850 Tag Monitor to monitor the data tag values through the gateway. It is automatically installed when you install the ProSoft MNET-61850 Configuration Manager.

2 Configuring the PLX82-MNET-61850 Gateway

To configure the PLX82-MNET-61850 gateway, follow these topics in the same order as they appear in this chapter.

You must import the Intelligent Electronic Device (IED) files before you configure the Modbus TCP/IP device so that the ProSoft MNET-61850 Configuration Manager can help with the Modbus TCP/IP configuration after you set up the IEDs in the ProSoft MNET-61850 Configuration Manager.

2.1 Connecting Your PC to the Gateway

Use an Ethernet cable to connect your PC to the ETH 1 port. Later, you can connect the gateway to a switch, allowing the IEDs, gateway, and M340, Quantum, or Premium PLC or PAC to all operate on the same network.

Once you connect the gateway, use the ProSoft Discovery Service to locate the gateway and assign a temporary IP address. See *Setting a Temporary IP Address in the Gateway* (page 13). You can set a permanent IP address when you configure the module. See *Ethernet Port Configurations* (page 17).

2.2 Setting a Temporary IP Address in the Gateway

Important: ProSoft Discovery Service (PDS) locates the gateway through UDP broadcast messages. PDS is an application that is built into ProSoft MNET-61850 Configuration Manager. These messages may be blocked by routers or layer 3 switches. In that case, PDS is unable to locate the gateways. To use PDS, arrange the Ethernet connection so that there is no router or layer 3 switch between the computer and the gateway OR reconfigure the router or layer 3 switch to allow the routing of the UDP broadcast messages.

- 1 In the *ProSoft Discovery Service* dialog, click on the **BROWSE FOR PROSOFT MODULES** icon to search for ProSoft Technology modules on the network.

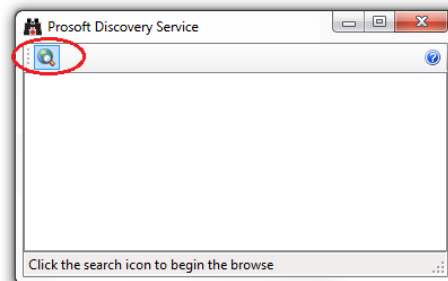

- 2 Right-click on the gateway, and then select **ASSIGN TEMPORARY IP**.

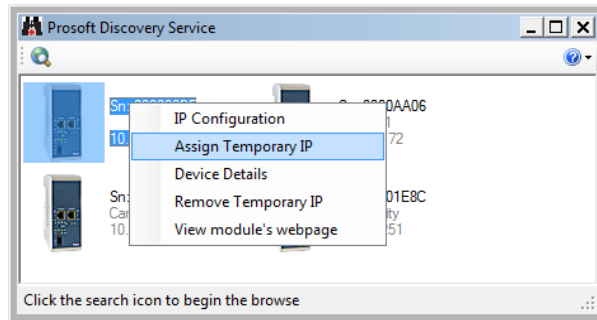

- 3 The module's default IP address is 192.168.0.250.
- 4 Enter an unused IP within your subnet, and then click **OK**.

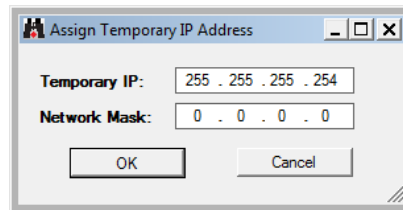

- 5 See Ethernet Port Configurations (page 17) to set the permanent IP address in the gateway.

2.3 Creating a New Project in the Configuration Manager

You configure the gateway with the ProSoft MNET-61850 Configuration Manager software. The first step is creating a project for the gateway.

- 1 If you have not installed the ProSoft MNET-61850 Configuration Manager, refer to Installing the ProSoft MNET-61850 Configuration Manager (page 12).
- 2 Click the Windows **START** button, and then choose **PROGRAMS > PROSOFT TECHNOLOGY > PROSOFT MNET-61850 CONFIGURATION MANAGER**.

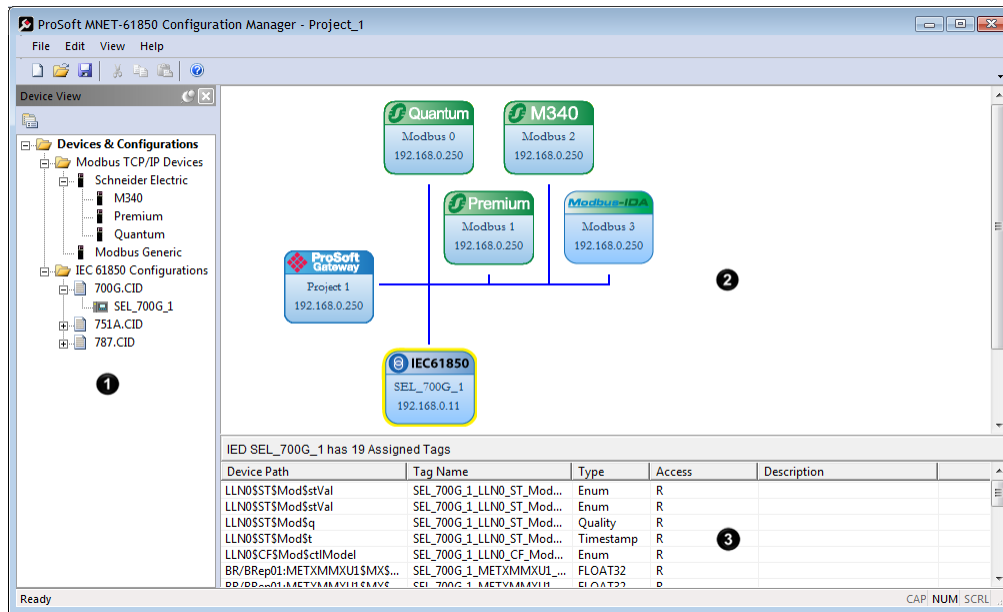

The ProSoft MNET-61850 Configuration Manager window consists three panes:

Step	Description
1	The <i>Device View Tree</i> shows the Modbus TCP/IP devices and IEC 61850 configurations. The IEC 61850 Configurations folder is a list of IED configuration files. This folder is empty until you import IED files.
2	The <i>Network View pane</i> shows a graphic representation of the devices to be connected to the gateway. Each device appears as a "bubble". The project bubble (ProSoft Gateway) represents the gateway itself. The IED bubbles (IEC61850) represent the IEC 61850 port on the gateway, and the attached devices. The Modbus TCP/IP bubbles (Quantum, Premium, M340) represent both the MNET port on the gateway, and the attached Modicon devices. Modbus-IDA represents a generic Modbus device.
3	The <i>Configured Tags pane</i> shows the configured tags associated with the currently selected "bubble" in the Network View pane.

- 3 When you first start the ProSoft MNET-61850 Configuration Manager, the *Device View* shows default devices and configuration, and the *Network View* shows only the project bubble (*ProSoft Gateway Project 1*).
- 4 Choose **FILE > NEW** to create a new project.

- 5 You can rename the project by right-clicking the project bubble, and then choosing **PROPERTIES**. You can also double-click the project bubble.
- 6 Enter a new name in **PROJECT NAME**, and any notes in **NOTES**, and then click **OK**.
- 7 Save the project by choosing **FILE > SAVE AS** and entering a name for the project.

Note: You will need a separate Configuration Manager file for each gateway. You can run multiple instances of the Configuration Manager software at the same time.

Note that the diagram in the *Network View* does not exactly match the physical hardware. In reality, the IED connects to the 61850 side of the gateway, while the Modbus TCP/IP device connects to the other side. Typically these three devices are connected across a network, rather than connected directly to each other.

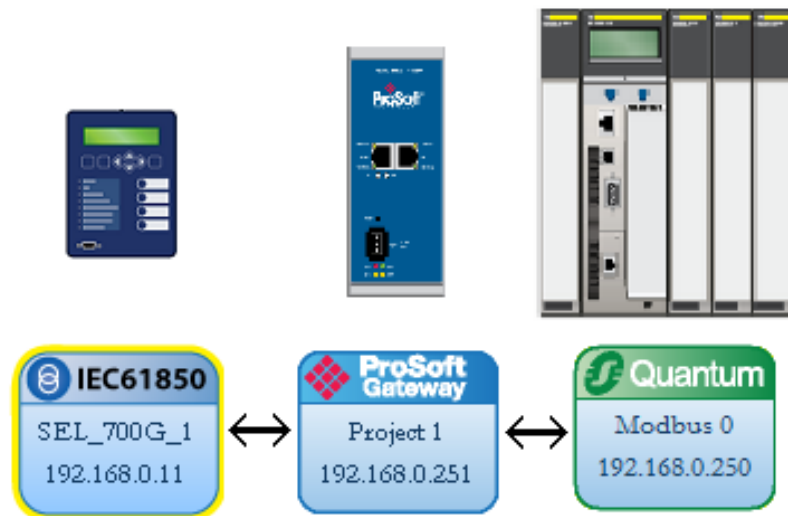

2.4 Importing a Project into the Configuration Manager

You can import a ProSoft MNET-61850 Configuration Manager file that was created and exported on a different PC. Do not try to open a project file created on another PC, because it does not contain all the IED files that were used to create it. Instead, choose **FILE > IMPORT CONFIGURATION**. This recreates all the CID/SCD/ICD files that were part of the original configuration.

If you open a project not created on your PC instead of importing it, the Device View shows a red slash through the IED files.

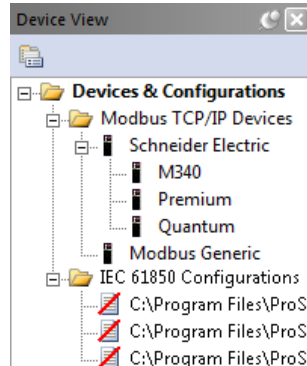

2.5 Ethernet Port Configurations

The PLX82-MNET-61850 can be configured to use both Modbus TCP/IP and 61850 protocols on the same physical Ethernet port (ETH 1) or separate Ethernet ports (ETH 1 and ETH 2). It also defines the NTP server that the gateway can poll for the current date and time.

Note: If the PLX82-MNET-61850 is configured to use one Ethernet port (ETH 1 port only) for both Modbus TCP/IP and 61850 protocols, the networks must be on the same subnet.

If the PLX82-MNET-61850 is configured to use separate Ethernet ports (ETH 1 and ETH 2) for each Modbus TCP/IP and 61850 protocol, the networks must be on different subnets.

- 1 Right-click the *ProSoft Gateway* bubble and choose **PROPERTIES**. You can also double-click the *ProSoft Gateway* bubble.

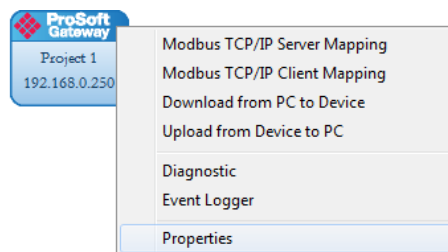

This displays the *ProSoft Gateway Configuration* dialog box.

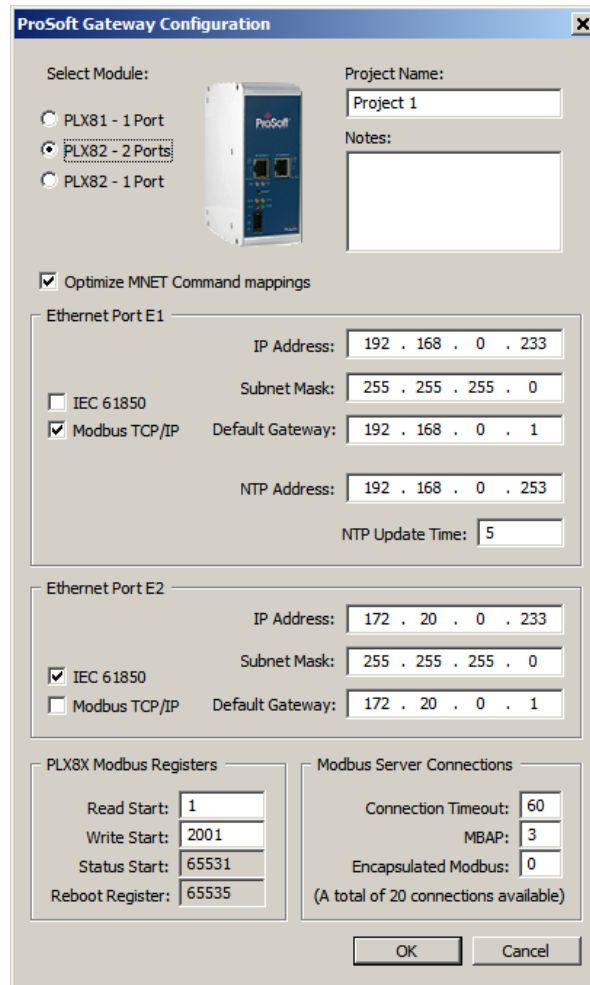

- 2 Select **OPTIMIZE MNET COMMAND MAPPINGS** option if you need to combine values from multiple tags into one Modbus Write (Function Code 16) command. The limit is 120 words (16 bit integers) per Modbus command. This feature helps with faster updates and throughput.
- 3 Select the desired PLX82 Port mode. You can use a dedicated Ethernet port for each protocol (**2 Ports**), or use the same Ethernet port for both protocols (**1 Port**).
- 4 Select the function of each port (IEC 61850 or Modbus TCP/IP).
- 5 Enter the IP address and other network information for the gateway port(s).
 - **IP ADDRESS:** The IP address must be a fixed IP address. Contact your network administrator for assistance.
 - **SUBNET MASK:** Enter the gateway's subnet mask.
 - **IP GATEWAY:** The IP gateway address is optional, and is not required for networks that do not use a default gateway.
- 6 Enter the **NTP ADDRESS**. The gateway polls the server for the current date and time. For example, in the USA, there are a number of time servers and their IP addresses listed at <http://tf.nist.gov/tf-cgi/servers.cgi>.

- 7 Enter the **NTP UPDATE TIME**. This is the polling interval (in minutes) for the current date and time. A value of 0 means the gateway does not poll the NTP server.
- 8 Enter the **PLX8x MODBUS REGISTERS** information. This is the PLX82-MNET-61850's beginning Modbus registers. This allows Modbus clients to access Modbus data on the gateway. All of the tags in the ProSoft tag database are in a numbered array of Modbus registers, addressed as **1** to **65535**. See Viewing Modbus TCP/IP Server Mapping (page 47) to look up the tag addressing.
 - **PLX READ START**: The address of the first Modbus read data register in the gateway's tag database for read-only IED data. A value of 1 means the first available Modbus read data register is accessed using a Modbus Holding Register address of 40001 (or 400001 if using six-digit addressing). Valid values are **1** to **65535**. The default value is 1.
 - **PLX WRITE START**: The address of the first Modbus write data register in the gateway's tag database for writable IED data. A value of 1000 means address 41001. Valid values are in the range **1** to **65535**. The default value is 1000.
- 9 Enter the **MODBUS SERVER CONNECTIONS** information. The gateway supports multiple MNET servers and MBAP servers.
 - **CONNECTION TIMEOUT**: This is the number of seconds the Server will wait to receive new data. If the Modbus TCP/IP server does not receive any new data during this time, it will close the Ethernet socket connection. Valid values are **0** to **1200** seconds. The default value is 60.
 - **ENCAPSULATED MODBUS**: This is the number of Modbus TCP/IP client devices that will communicate with the gateway using TCP/IP Service Port 2000. These are devices that use Modbus RTU serial-style message structures enclosed in an Ethernet wrapper.
 - **MBAP**: This is the number of Modbus TCP/IP client devices that will communicate with the gateway using Schneider Electric MBAP-style messages on TCP/IP Service Port 502.
- 10 Click **OK** and save the project.

3 61850 Configuration

3.1 Importing IED Files

After you have configured the gateway in the project, the next step is to import the configured Intelligent Electronic Device (IED) files into the project. IEDs come with a template ICD file, but an ICD file indicates possible configuration options. It usually does not contain specific configuration information. For instance, ICD files usually do not have an IP Address or other configured elements in them. Once an IED has been configured (using third-party configuration software provided by the IED manufacturer), the manufacturer's software usually creates a specific CID configuration file. Some third-party software may also create a SCD system configuration file (an SCD usually has multiple IEDs in it).

Note: You can only import configured ICD, CID, and SCD files. These files must be fully configured and saved in the software that is used to configure the IEDs. The configured file must include the IP address, subnet mask, and gateway address (if required by the network). Also, each IED must have a unique Device Name and IP address.

Important: The ICD, CID, SCD file that is being loaded into the Gateway **MUST** be identical to the file that is loaded in the IED device.

To import configured IED files:

- 1 In the *Device View* pane of the ProSoft MNET-61850 Configuration Manager, right-click **IEC 61850 CONFIGURATION** and then choose **ADD IED**.

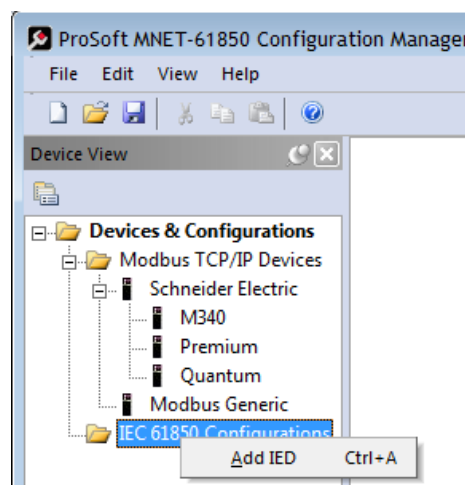

- 2 In the *Open* dialog box, browse to the directory containing the ICD, CID, or SCD file.

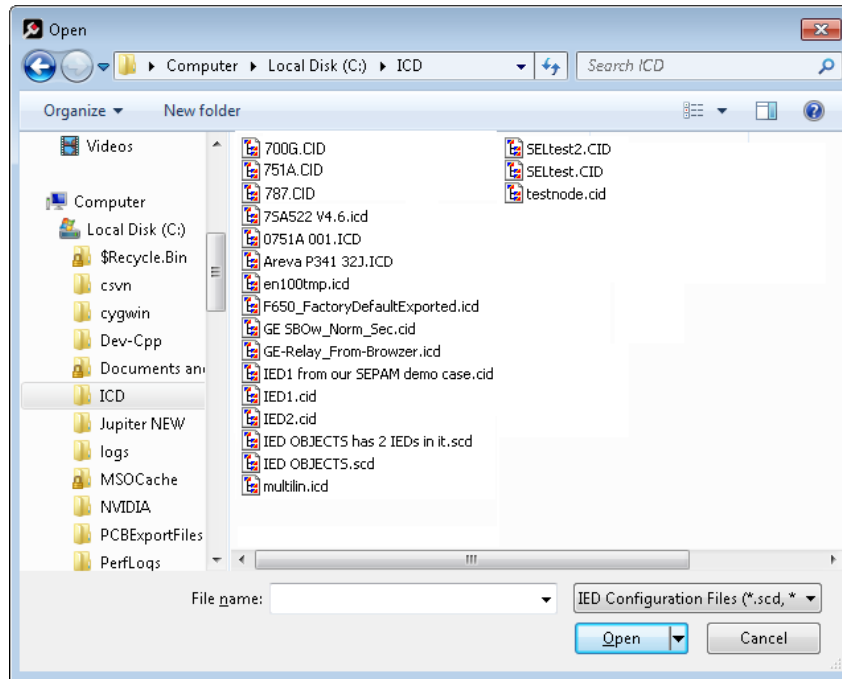

- 3 Make sure the file type is **IED CONFIGURATION FILES (*.SCD, *.ICD, *.CID)**.
- 4 Each IED has its own configuration file, except for SCD files which can contain more than one IED. Select one or more configuration files to import and click **OPEN**. The imported IED files appear in the *Device View* tree under **IEC 61850 CONFIGURATION**.

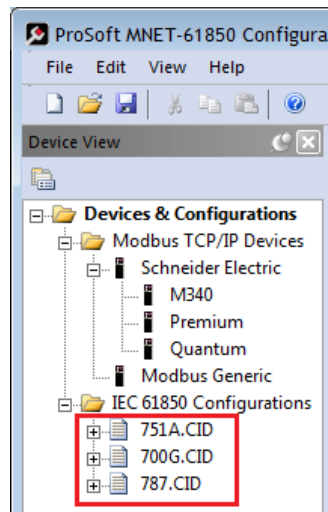

- 5 Repeat the above steps to import the rest of your IED files.

- 6 If you are familiar with the contents of CID, SCD, and ICD files, you can right-click the file name and then choose **DISPLAY** to see the contents of the file in the default text editor.

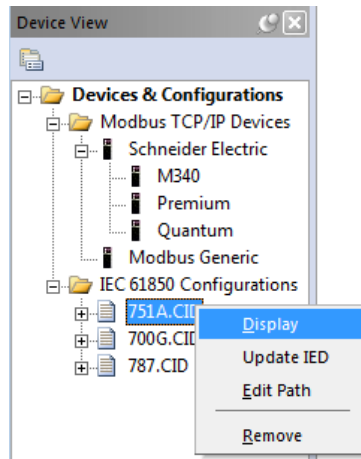

Note: Normally you only view the configuration files in the text editor for reference if you are familiar with these files. If you want to change the IED configuration, use the configuration software for the IED.

3.2 Creating the IED Network

After you have imported the IED files, you can create the IED 61950 network in the ProSoft MNET-61850 Configuration Manager.

To create the IED network configuration:

- 1 In the *Device View* pane of the Configuration Manager, expand the IED file name (700G.CID in this example) by clicking the **[+]** sign next to the file name.
- 2 Click and drag the IED name (*SEL_700G_1* in this example) from the *Device View* pane into the *Network View*. When you release the mouse button, the IED is added to the view in an *IEC 61850* bubble. The bubble shows the IED Device Name and IP address. These values are from the IED file and cannot be changed in the Configuration Manager.

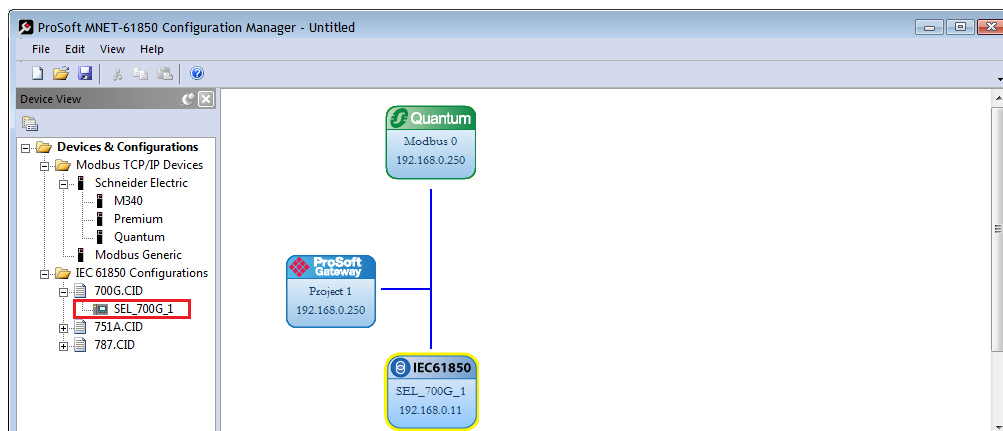

- 3 Repeat the above steps to add the rest of your IEDs to the *Network View* pane.

To delete an IED from the Network View:

Right-click the IED bubble in the *Network View* and choose **DELETE**.

To change the MMS Scan Delay:

You can change the MMS Scan Delay for any IED. This is the only property you can change for an IED, as everything else is set in the IED configuration file.

Right-click the IED bubble in the *Network View* and choose **PROPERTIES**. By default, the **MMS SCAN DELAY** is set to 1000 milliseconds.

IEC 61850 Reports and GOOSE messages are generated by the IED and are not affected by the MMS Scan Delay. The MMS Scan Delay parameter also has no impact on MMS writes. The lower you set the MMS Scan Delay value, the more network capacity is consumed by MMS Read network traffic. If you do not configure an IED to read any Data Attributes using MMS messages, then this parameter has no effect.

The **EDIT NETWORK SETTINGS** button is only for troubleshooting under the direction of ProSoft Technical Support.

To locate the IED file:

The Configuration Manager stores its own copy of the CID, SCD, or ICD file for this IED.

- 1 Right-click the IED bubble in the *Network View* and choose **PROPERTIES**.
- 2 Click the **DETAILED PROPERTIES** tab to see the path on your PC where the Configuration Manager stores the file.

3.3 Mapping Data Attributes from IEDs to the Gateway

As you add IEDs to the *Network View*, the ProSoft MNET-61850 Configuration Manager reads the device information and builds a list of tags (Data Attributes) from the device file. In this step, you map tags from the IED to the gateway database. This is the first of two steps in mapping data from the IED to the PAC:

- 1 First, you map the tag from the device to the gateway. This creates a location in the gateway database to store the data associated with the tags.
- 2 Second, you map the tag from the gateway database to the gateway Modbus TCP/IP port. This sets up an MMS data movement (IEC 61850-8-1) to push the data to the Rockwell Automation® Modicon® Quantum® PLC, Premium® PLC, or M340® PAC (if the tag can be read) or to write to data to the device (if the tag can be written). Refer to Mapping Data Attributes in the Gateway to Modbus TCP/IP (page 36) for this second step.

Note: Remember that you must configure the gateway so that the IP address is in the same subnet as the 61850 relay device. Refer to Ethernet Port Configurations (page 17).

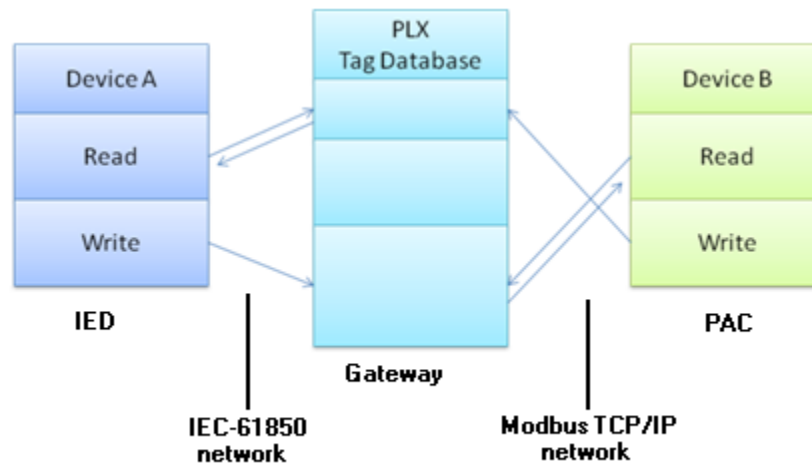

After you have mapped data attributes from one or more IEDs, you can view the mapped data attributes by right-clicking the project bubble and choosing **MODBUS TCP/IP SERVER MAPPING**. See Viewing Modbus TCP/IP Server Mapping (page 47).

3.3.1 Mapping MMS Messages

MMS messages can be read-only (read the value from the IED) or write (write the value to the IED).

- 1 In the *Network View* pane in the ProSoft MNET-61850 Configuration Manager, right-click the *IED* bubble that you want to map, and choose **CONFIGURE**.

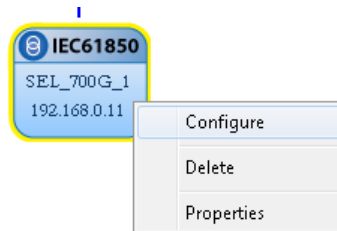

This displays the *IEC 61850 Mapping Tool* window. The window contains the tree view on the left, and the mapping table on the right.

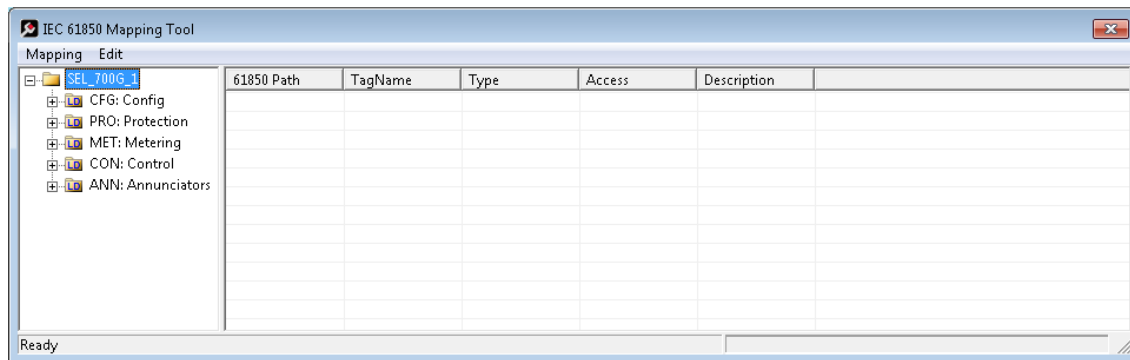

- 2 In the tree view on the left, expand the root folder (click the **[+]** sign). This shows the Logical Devices in the IED (notice the little LD in the icon).
- 3 Expand one of the Logical Devices in the IED (click the **[+]** sign) to see the Logical Nodes within it (notice the little LN in the icon). Some IED manufacturers provide descriptive information in their CID files. The ProSoft MNET-61850 Configuration Manager displays that information after the Logical Node name.

- 4 Continue to expand the Logical Node to display the Data Object (DO) and finally the individual Data Attributes. The functional constraint for a data attribute appears on the icon; for example CO for control, ST for status information, and CF for configuration. See Functional Constraints (page 113).

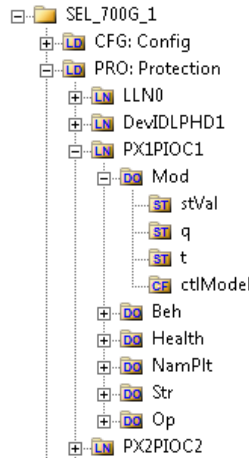

- 5 Click and drag a Data Attribute from the tree into the mapping table on the right. When you drop the Data Attribute, it fills in the table with the following values:
 - **61850 PATH** to the Data Attribute.
 - **TAGNAME** generated for the Data Attribute. This can be quite long, and is close to the actual Data Attribute name. Most devices have tag names that are short enough to map to RSLogix5000 projects. For tags that exceed this length, the Configuration Manager automatically shortens the name, ending with a sequence number (_001, _002, ...).
 - **TYPE** is the data type for the Data Attribute.
 - **ACCESS:** The Configuration Manager determines the read/write access of the tag the tag's functional constraints:
R indicates data that the gateway can read from the IED.
W indicates data that the gateway can write to the IED.
 - **DESCRIPTION:** Enter a description for this Data Attribute.

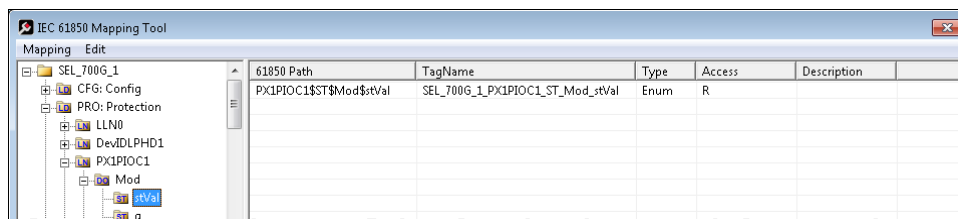

After you save the mapped tags, if you re-open the *IEC 61850 Mapping Tool* window, MMS read and write tags are highlighted in red. Report and Goose Message tags are not highlighted.

- 6 To delete tags, select the tag or tags in the table, then right-click the selected tags and choose **DELETE**.
- 7 Repeat until you have mapped the tags for the IED.

- Choose **MAPPING > SAVE** to save the tag mapping. The mapped tags appear in the *Assigned Tags* pane at the lower-right of the Configuration Manager when you click the IED bubble.

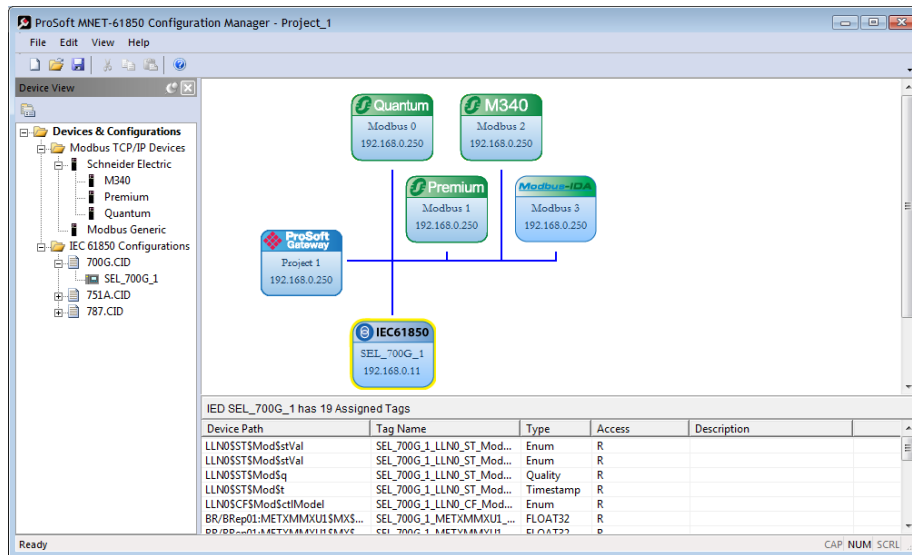

Note: You can click and drag a higher level object (such as a logical node (LN), a logical device (LD), or the IED) to map ALL the child tags descending from the higher level object. For MMS Write Data Attributes, see Mapping MMS Write Messages (page 28).

- At this point, you have mapped the tags from the IED to the gateway internal database. If you download the configuration to the gateway at this point, the IEC 61850 client starts to read the values of the Data Attributes from the IED. The gateway processes the list of configured IEDs in order, one at a time, based on the MMS Scan Delay Timer. This parameter defines the interval between MMS Read commands. See Creating the IED Network (page 23) for more on this parameter.
- The next step is to map the tags from the internal database to the Modbus TCP/IP output. Refer to Mapping Data Attributes in the Gateway to Modbus TCP/IP (page 36).

Note: If your application requires more Data Attributes than the supported number of Modbus TCP/IP client commands, then the application requires the PLC or PAC to operate as a Modbus TCP/IP client and poll the remaining Data Attributes from the gateway.

You can map other data values from the IED. See:

- Mapping Reports (page 29)
- Mapping GOOSE Messages (page 32)

3.3.2 Mapping MMS Write Messages

You map MMS Write messages using the same steps described for all MMS messages. See Mapping MMS Messages (page 25). For writable data, drag and drop the Oper structure from the tree view on the left to the right-hand side of the window.

Important: In addition to the Oper structure, some IEDs also offer SBOw and Cancel structures within the same Data Object. For the gateway, you only need to map the Oper structure. Do not map the SBOw. The Cancel structure should only be mapped if it is required.

We strongly recommend that you map all of the Data Attributes surrounding the actual control value, and set up another exchange to read it before changing the control value and performing a write from the PLC or PAC side.

In the ProSoft MNET-61850 Configuration Manager, Oper structures that are supported by the IED have a green indicator, meaning that these may be mapped to the gateway. Those with a red indicator are not required to be mapped.

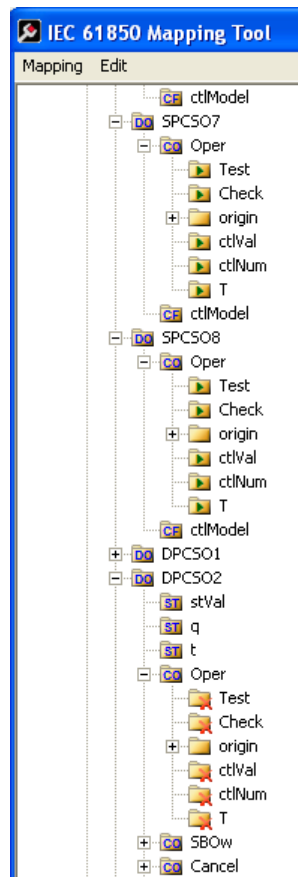

3.3.3 Mapping Reports

Reports are based upon a DATA-SET, containing a specific collection of Data Attributes. You can configure the gateway to enable an IED's Buffered Report Control Blocks (BRCBs) or Unbuffered Report Control Blocks (URCBs).

Note: Be sure that the DATA-SET on your IED contains all Data Attributes and not Data Objects.

- 1 In the *Network View* pane in the ProSoft MNET-61850 Configuration Manager, right-click the *IED* bubble that you want to map, and choose **CONFIGURE**.

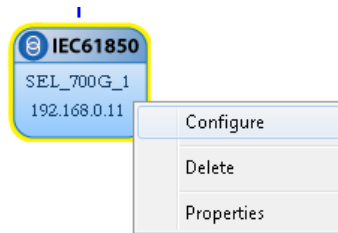

This displays the *IEC 61850 Mapping Tool* window.

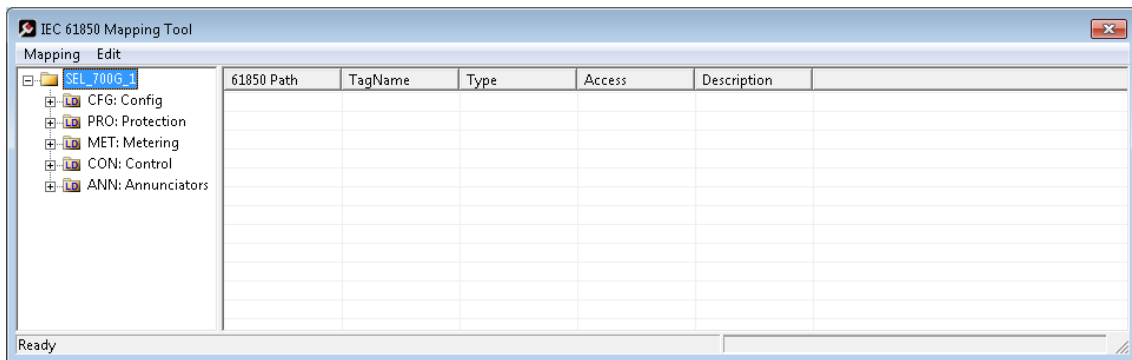

- 2 In the tree view on the left, expand the root folder (click the **[+]** sign).
- 3 Expand the Logical Device to see the Logical Nodes (click the **[+]** sign).
- 4 Continue to expand the Logical Node to display the Reports Object (RPT) and finally the individual Reports.

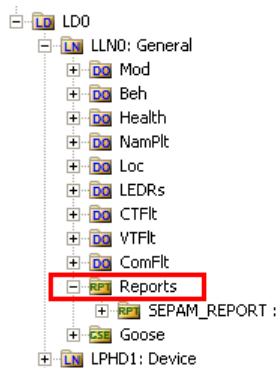

You can right-click a report name to see more information about the report, such as the Trigger Options and Report Control Block information.

- 5 Click and drag the yellow folder showing the report name from the left side to the right side of the window. This maps the entire DATA-SET. You can also expand the individual report, then click and drag individual Data Attributes to the right side of the window. The functional constraint for a data attribute appears on the icon; for example ST for status information. See Functional Constraints (page 113).
- 6 The Configuration Manager automatically populates the table with one row for each Data Attribute in that DATA-SET. When you drop the report or Data Attribute, it fills in the table with the following values:
 - **61850 PATH** to the Data Attribute.
 - **TAGNAME** generated for the Data Attribute. This can be quite long, and is close to the actual Data Attribute name. Most devices have tag names that are short enough to map to RSLogix5000 projects. For tags that exceed this length, the Configuration Manager automatically shortens the name, ending with a sequence number (_001, _002, ...).
 - **TYPE** is the data type for the Data Attribute.
 - **ACCESS:** the ProSoft MNET-61850 Configuration Manager determines the read/write access of the tag the tag's functional constraints:
R indicates data that the gateway can read from the IED.
W indicates data that the gateway can write to the IED.

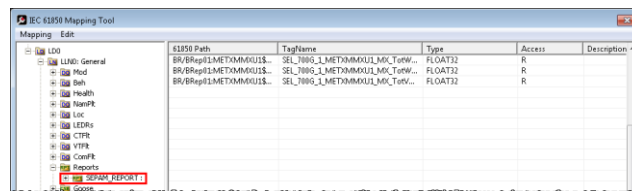

After you save the mapped tags, if you re-open the *IEC 61850 Mapping Tool* window, MMS read and write tags are highlighted in red. Report and Goose Message tags are not highlighted.

- 7 To delete tags, select the tag or tags in the table, then right-click the selected tags and choose **DELETE**.
- 8 Repeat until you have mapped the reports and individual Data Attributes for the IED.

Warning: When the IED tag mapping is complete, saving this configuration will update the corresponding tag's remote Modbus Server's register addresses in the *MB Addr* column.

- 9 When ready, select **MAPPING > SAVE** to save the tag mapping. The mapped report tags appear in the *Assigned Tags* pane at the lower-right of the Configuration Manager when you click the IED bubble.

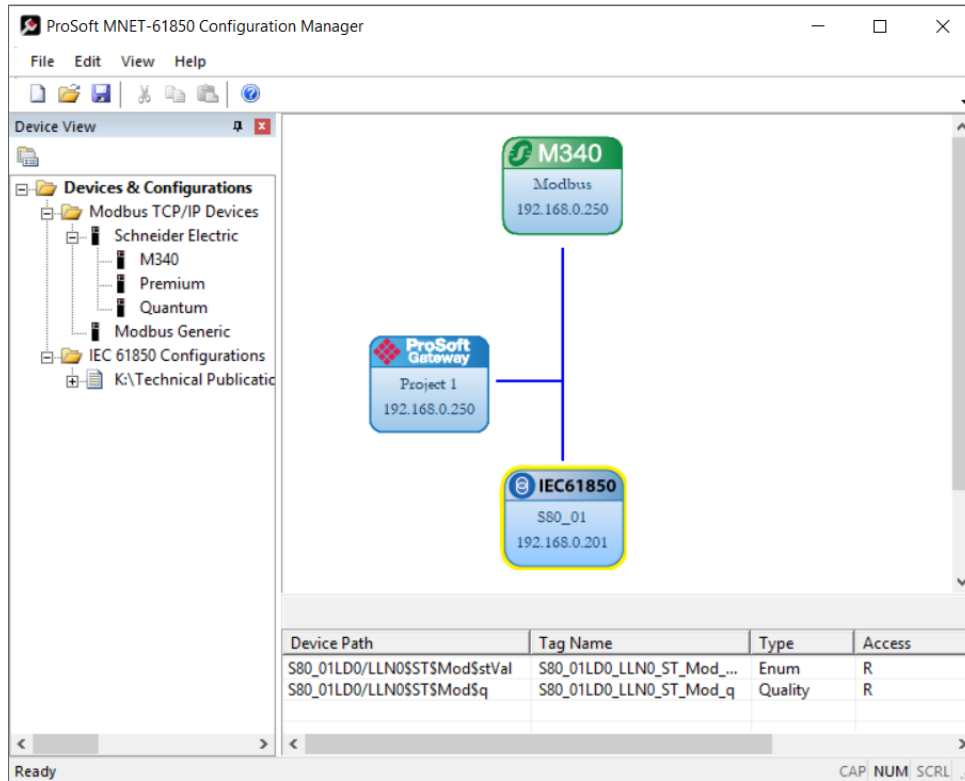

Note: The gateway stores the entire DATA-SET of data in the tag database. This makes a consistently-sized set of data is available to the other protocol. You configure which Data Attributes are available when you map tags to the Modbus TCP/IP side of the gateway. See Mapping Data Attributes in the Gateway to Modbus TCP/IP (page 36).

Report options are used as they are defined in the IED. The gateway supports General Interrogation (GI). Upon report enable, if the Report's trigger options have it set to TRUE, the gateway initiates a General Interrogation. This occurs during the first connection that the gateway makes to the IED, and on any subsequent reconnections. This ensures the gateway has a current snapshot of the values of all members of the report's DATA-SET.

3.3.4 Mapping GOOSE Messages

GOOSE (Generic Object Oriented Substation Events) messages are based upon a DATA-SET, containing a specific collection of Data Attributes. You can configure the gateway to enable an IED's GOOSE messages. GOOSE messages are based upon a DATA-SET. An entire GOOSE message must fit in one Ethernet packet. According to the IEC 61850 Standard, GSEControl information is only allowed in the logical node LLN0.

- 1 In the *Network View* pane in the ProSoft MNET-61850 Configuration Manager, right-click the *IED* bubble that you want to map, and choose **CONFIGURE**.

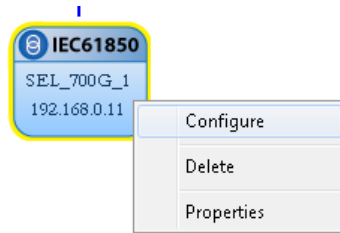

This displays the *IEC 61850 Mapping Tool* window.

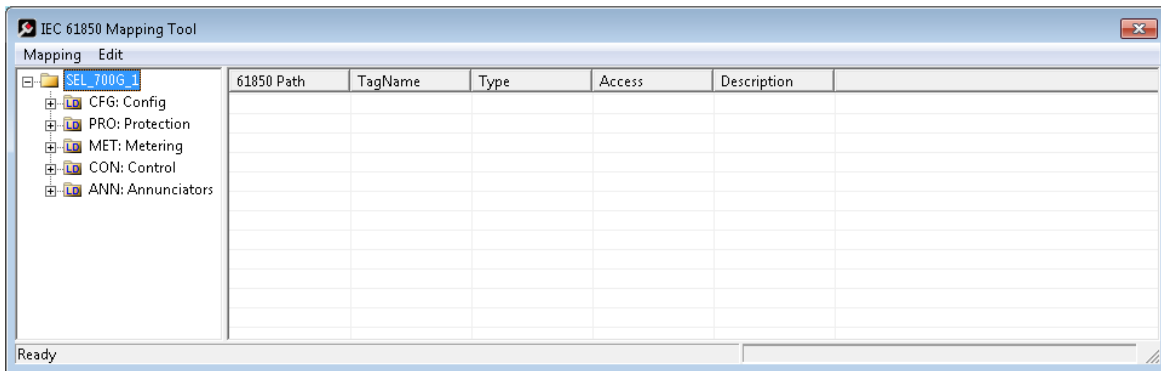

- 2 In the tree view on the left, expand the root folder (click the **[+]** sign).
- 3 Expand the Logical Device to see the Logical Nodes (click the **[+]** sign).
- 4 Continue to expand the Logical Node to display the GOOSE (GSE) and finally the individual DATA-SETS.

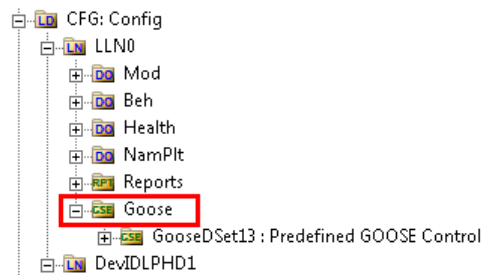

- 5 Click and drag the yellow folder showing the DATA-SET name from the left side to the right side of the window. This maps the entire DATA-SET. You can also expand the individual DATA-SET, then click and drag individual Data Attributes to the right side of the window. The functional constraint for a data attribute appears on the icon; for example ST for status information. See Functional Constraints (page 113).
- 6 The Configuration Manager automatically populates the table with one row for each Data Attribute in that DATA-SET. When you drop the report or Data Attribute, it fills in the table with the following values:
 - **61850 PATH** to the Data Attribute. The ProSoft MNET-61850 Configuration Manager adds GOOSE as a prefix to the standard IEC-61850 path.
 - **TAGNAME** generated for the Data Attribute. This can be quite long, and is close to the actual Data Attribute name. Most devices have tag names that are short enough to map to the PLC or PAC. For tags that exceed this length, the Configuration Manager automatically shortens the name, ending with a sequence number (_001, _002, ...).
 - **TYPE** is the data type for the Data Attribute.
 - **ACCESS:** the ProSoft MNET-61850 Configuration Manager determines the read/write access of the tag the tag's functional constraints:
R indicates data that the gateway can read from the IED.
W indicates data that the gateway can write to the IED.

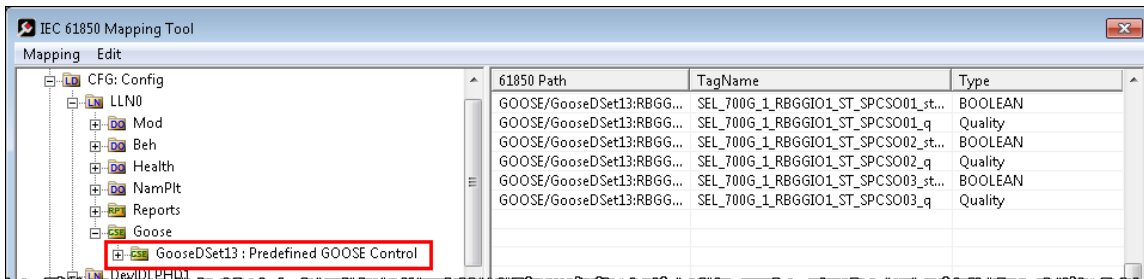

After you save the mapped tags, if you re-open the *IEC 61850 Mapping Tool* window, MMS read and write tags are highlighted in red. Report and Goose Message tags are not highlighted.

- 7 To delete tags, select the tag or tags in the table, then right-click the selected tags and choose **DELETE**.
- 8 Repeat until you have mapped the GOOSE DATA-SETS and individual Data Attributes for the IED.

Warning: When the IED tag mapping is complete, saving this configuration will update the corresponding tag's remote Modbus Server's register addresses in the *MB Addr* column.

- 9 When ready, select **MAPPING > SAVE** to save the tag mapping. The mapped tags appear in the *Assigned Tags* pane at the lower-right of the Configuration Manager when you click the IED bubble.

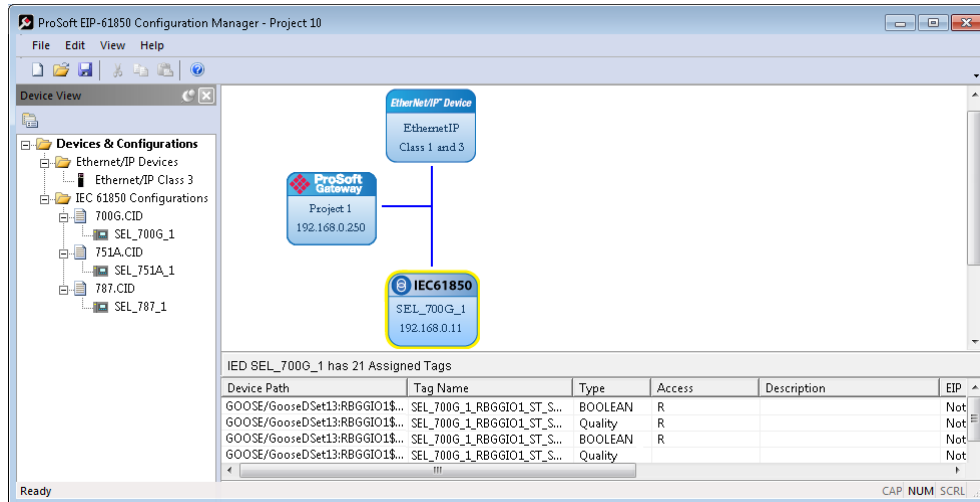

3.3.5 GOOSE Message Assumptions

The ProSoft gateway supports both Modbus TCP client and server, and it can act as a client and server at the same time. Once you have configured your application, ProSoft 61850 Configuration Manager automatically generates the file that is required by Unity Pro for Quantum, Premium, or M340 processors so that all data that is exchanged between the gateway and the PLC or PAC is already mapped to the correct Modbus addresses. These files are configured so that:

- The data transferred from the gateway to the PLC or PAC is pushed from the gateway as a Modbus TCP/IP Client. The generated .XSY files map the tag names to the Modbus addresses in the PLC or PAC which receive the values from the gateway.
- The controllable Data Attributes that the PLC or PAC transfers to the gateway are pushed from the PLC or PAC (operating as a Modbus TCP/IP client) to the gateway (operating as a Modbus TCP/IP server). The generated .XFM file generate the function block and associated variables to write the data to the gateway.

The sample file generated by the ProSoft MNET-61850 Configuration Manager assumes that the read data is transferred with the gateway as a Modbus TCP/IP Client, and the controllable data is transferred with PLC or PAC as a Modbus TCP/IP Client.

You may want to set up GOOSE messages in the IEDs specifically for the data you need to send to the ProSoft gateway, so that only the necessary data is contained in the GOOSE message.

3.3.6 *Deleting One or More IEC 61850 Mappings*

You can delete one or more MMS messages, Report, and GOOSE mapping from the IED to the gateway.

- 1 In the *Network View* pane in the ProSoft MNET-61850 Configuration Manager, right-click the *IED* bubble that you want to map, and choose **CONFIGURE**.
This displays the *IEC 61850 Mapping Tool* window. The mappings are listed in the table on the right side of the window.
- 2 Select the mappings in the table, then right-click the selected mappings and choose **DELETE**. You can also delete all the mappings by choosing **EDIT > CLEAR ALL**.

Note: If you delete a mapping from the IED to the Gateway and save the project, it will also delete the corresponding mapping on the Modbus TCP/IP side of the Gateway. See Mapping Data Attributes in the Gateway to Modbus TCP/IP (page 36).

4 Modbus TCP/IP Configuration

4.1 Adding Modbus TCP/IP Devices

To add Modbus TCP/IP devices to the network, click and drag a Modbus TCP/IP device from the *Device View* tree into the *Network View* pane. This creates the Modbus device bubble in the *Device View*. You can add multiple Modbus devices, and there are four device types: **Quantum**, **Premium**, and **M340** represent both the MNET port on the gateway, and the attached Modicon devices; **Modbus-IDA** represents a generic Modbus device.

- If you are using a NOE card between the PLC or PAC and the gateway, choose the Quantum device type.
- If you are using some other Modbus device to communicate with the gateway, then choose the Modbus Generic device type.

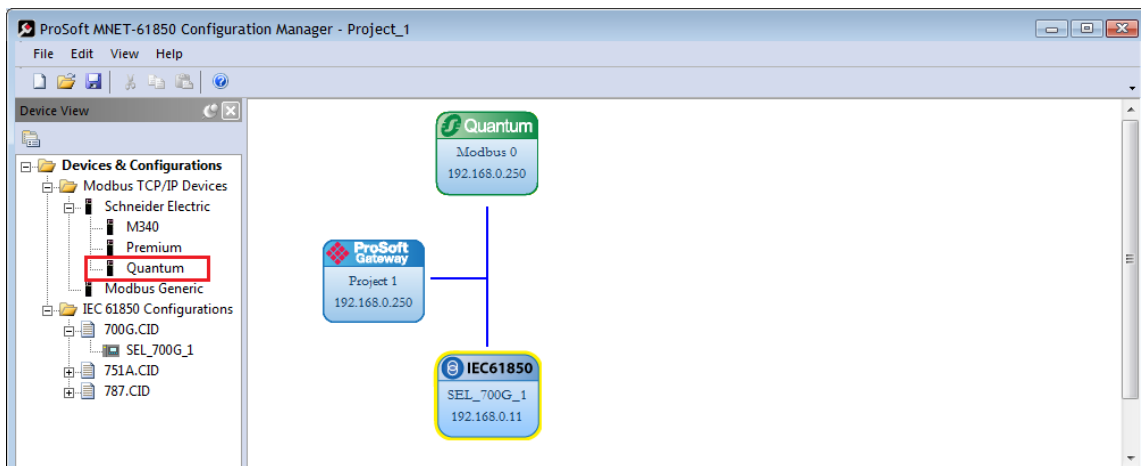

To copy a configured Modbus device

Right-click the device bubble in the *Network View* pane and choose **COPY**. Then right-click the *Network View* pane background and choose **PASTE MODBUS DEVICE**.

To delete a Modbus device

Right-click the device bubble in the *Network View* pane and choose **DELETE**.

To map tags in a Modbus device

To map the tags that you want to make available to a Modbus scanner such as PLC or PAC, right-click the device bubble and choose **CONFIGURE**. See Mapping Data Attributes in the Gateway to Modbus TCP/IP (page 36).

To edit Modbus device properties

Right-click the device bubble in the *Network View* pane and choose **PROPERTIES**. See *Setting Modbus TCP/IP Port Properties* (page 39). To display the PLC or PAC map view for the device right-click the device bubble in the *Network View* pane and choose **PLC MAP VIEW**. See *Viewing the Modbus Commands for a Device* (page 44).

4.2 Mapping Data Attributes Modbus TCP/IP

After you have mapped the MMS messages, Report, and GOOSE mapping from the IED to the gateway, you must map these tags to the Modbus TCP/IP side of the gateway. This makes the tags and associated data available to the PLC or PAC. This is the second of two steps in mapping data from the IED to the PLC or PAC.

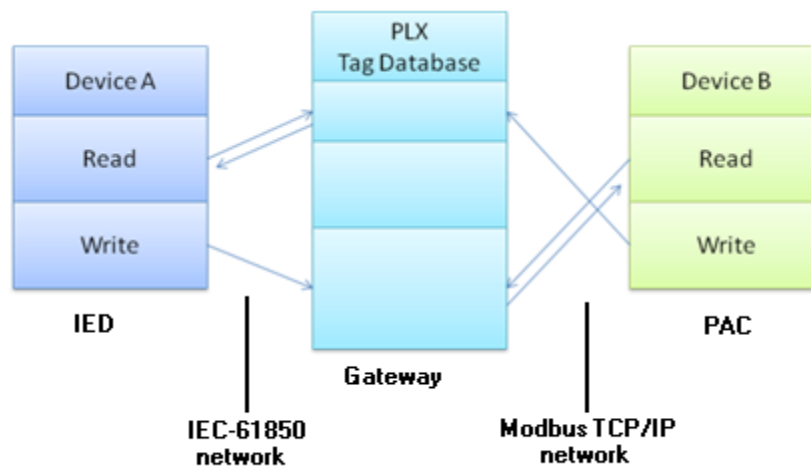

- 1 First, you map the tag from the device to the gateway. This creates a location in the gateway database to store the data associated with the tags. See *Mapping Data Attributes from IEDs to the Gateway* (page 24) for this first step.
- 2 Second, you map the tag from the gateway database to the gateway Modbus TCP/IP port. This sets up an MMS data movement (IEC 61850-8-1) to push the data to the PLC or PAC (if the tag can be read from the IED) or to write to data to the IED (if the tag can be written to the IED).

In the *Network View* pane in the ProSoft MNET-61850 Configuration Manager, double-click the *M340*, *Premium*, *Quantum*, or *Modbus-IDS* bubble. You can also right-click the bubble and then click **CONFIGURE**.



This displays the *Modbus Mapping Tool* window. See Modbus TCP/IP Commands (page 42) for a description of the columns in this table.

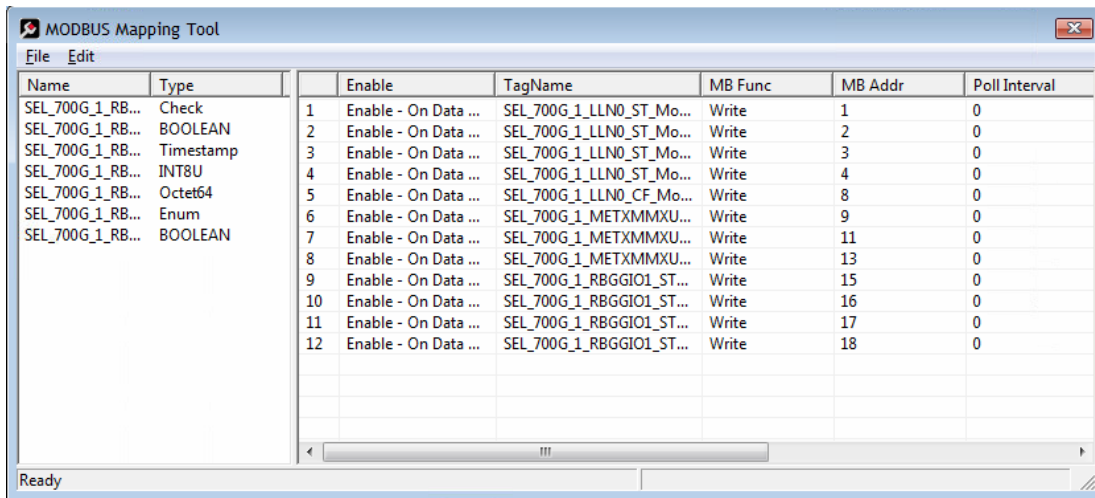

Note: The ProSoft MNET-61850 Configuration Manager automatically maps MMS Read Data Attributes that you mapped (Device View) from the IED to the gateway database for the M340, Premium, and Quantum and Modbus-IDA (Generic) devices. It does not automatically map MMS Write Data Attributes for any device.

The tags (Data Attributes) you mapped from the IED to the gateway appear on the left-hand side of the window. The tags that you mapped (or are automatically mapped) from the gateway to the Modbus TCP/IP port appear on the right-hand side of the window.

To map tags to the Modbus TCP/IP port

Click and drag one or more tags from the left-hand side to the right-hand side.

To delete one or more mappings

Right-click the mappings you want to delete in the right-hand side, then choose **DELETE**. You can delete all mappings by choosing **EDIT > CLEAR ALL**. Deleting a mapping on the Modbus TCP/IP side of the gateway does not delete the mapping from the IED to the Gateway.

Note that if you delete a mapping from the IED to the Gateway, you also delete the corresponding mapping on the Modbus TCP/IP side of the Gateway. See Deleting one or more IEC 61850 mappings (page 35).

To set the Modbus TCP/IP Port properties

See Setting Modbus TCP/IP Port Properties (page 39).

To configure Modbus TCP/IP commands for mapped tags

See Configuring Modbus TCP/IP Commands for a Device (page 41).

After you have mapped data attributes to one or more Modbus devices, you can view the mapped data attributes for all Modbus devices by right-clicking the project bubble and choosing **MODBUS TCP/IP CLIENT MAPPING**. See Viewing Modbus TCP/IP Client Mapping (page 48).

Warning: When the IED tag mapping is complete, saving this configuration will update the corresponding tag's remote Modbus Server's register addresses in the *MB Addr* column.

4.3 Setting Modbus TCP/IP Port Properties

You can configure the Modbus TCP/IP port properties, including the address of the server device, PLC or PAC write and read start registers.

In the Network View pane in the ProSoft MNET-61850 Configuration Manager, double-click the *M340*, *Premium*, *Quantum*, or *Modbus-IDS* bubble. You can also right-click the bubble and then click **PROPERTIES**.

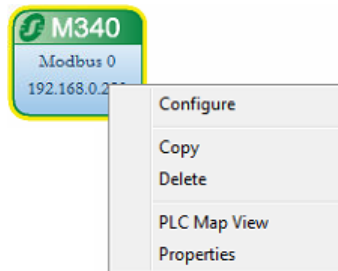

This displays the Modbus TCP/IP Device Configuration dialog box. This dialog box is for the Quantum PLC device. The fields in the dialog box are different for different types of Modbus devices.

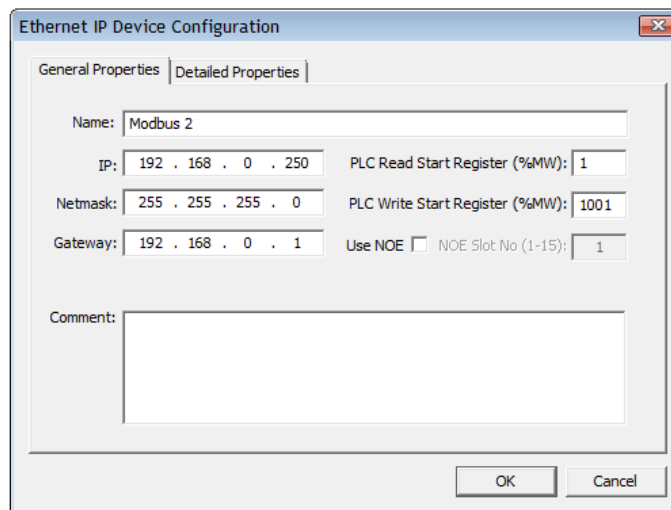

General Properties tab	Description
Name	Name of the PLC, this is informational only.
IP	The IP address of the target device being accessed by the gateway's Modbus TCP/IP Client commands. Format is xxx.xxx.xxx.xxx
Netmask	This is the setting for the TCP/IP network hosting the ProSoft Gateway. The default value of 255.255.255.0 will work for many installations, or you can ask your network administrator for the correct setting.
Gateway	The gateway address is the address of the computer, server, or router that passes traffic between a workstation on the local subnet to devices on different subnets or remote networks.
PLC Read Start Register (%MW)	This is the starting address in the PLC to which the ProSoft gateway will write. (The gateway writes with Modbus Function Code 16.) Entering a value of 1 means the gateway will write to PLC starting address of 40001. The default value is 1
PLC Write Start Register (%MW)	This is the starting address in the PLC from which the ProSoft gateway will read. Entering a value of 1000 means the gateway will read from the PLC starting at address %MW1000 (41000). The default value is 1000
NOE Slot No (1-15)	Note: If you're using a Schneider Electric NOE Ethernet module in the rack, rather than the processor's built-in Ethernet port (available on certain processors), then check this check box. NOE Slot No (1-15): If using an NOE Ethernet module, enter the NOE's slot number in the rack here. This is informational only.

Detailed Properties tab	Description
Minimum Command Delay	This is the minimum number of milliseconds between commands. Valid values range from 0 to 32767. The default value is 0. This parameter can be used to delay all commands sent to the Modbus TCP/IP Server (PLC) to avoid "flooding" commands on the network. This parameter does not affect retries of a command as they will be issued when failure is recognized.
Response Timeout	This is the time in milliseconds that the Modbus TCP/IP Client will wait before re-transmitting a command if no response is received from the addressed Server. Valid values range from 0 to 65535. The default value is 1000. The value to use depends upon the type of communication network used, and the expected response time of the slowest device on the network.
Retry Count	This parameter specifies the number of times a failed command will be retried before being skipped and sending the next command in the Command List. Valid values range from 0 to 10. The default value is 0.
Command Error Delay	This parameter specifies the number of 100 millisecond intervals to suspend execution of a command in the Command List after it fails. If this parameter is set to 0, there will be no delay. Valid values range from 0 to 300. The default value is 300.

4.4 Configuring Modbus TCP/IP Commands for a Device

4.4.1 Modbus TCP/IP Client Commands Overview

The Modbus TCP/IP Client driver uses a command list to define interactions between the ProSoft gateway and Modbus TCP/IP server devices. The commands in the list specify the server device to be addressed, the function to be performed (read or write), the data area in the device with which to interface, and the registers in the tag database to be associated with the command. The Client command list supports up to 1000 commands.

The Modbus Write Commands (Function Code 16) can be 'Optimized'. This feature combines up to 120 registers of Tags into one FC16 command. This helps with faster output and update times. For example, if there are 11 tags with 12 words each (132 total registers), this feature will combine the first 10 tags (120 registers worth of tags) into the 1st FC16 command and the 11th tag will be sent in the 2nd F16 command. Without optimization, eleven FC16 commands are needed to send the 132 registers.

The optimization feature must be enabled in the *ProSoft Gateway Configuration* dialog.

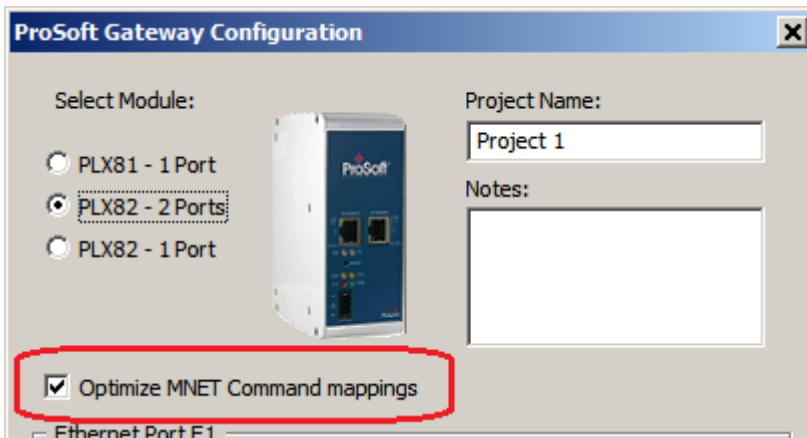

Note: Modbus Read (Function Code 3) commands are not optimized. Each tag forms its own F3 command.

4.4.2 Modbus TCP/IP Commands

You can configure the Modbus TCP/IP commands for mapped Data Attributes (tags) in the *Modbus Mapping Tool* window.

- 1 In the Network View pane in the ProSoft MNET-61850 Configuration Manager, double-click the *M340*, *Premium*, *Quantum*, or *Modbus-IDS* bubble. You can also right-click the bubble and then click **CONFIGURE**.

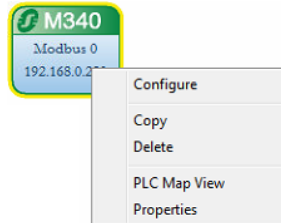

This displays the *Modbus Mapping Tool* window. For the steps to map Data Attributes to the Modbus TCP/IP port, see Mapping Data Attributes in the Gateway to Modbus TCP/IP (page 36).

Name	Type	Enable	TagName	MB Func	MB Addr	Poll Interval
SEL_700G_1_RB...	Check	1 Enable - On Data ...	SEL_700G_1_LLNO_ST_Mo...	Write	1	0
SEL_700G_1_RB...	BOOLEAN	2 Enable - On Data ...	SEL_700G_1_LLNO_ST_Mo...	Write	2	0
SEL_700G_1_RB...	Timestamp	3 Enable - On Data ...	SEL_700G_1_LLNO_ST_Mo...	Write	3	0
SEL_700G_1_RB...	INT8U	4 Enable - On Data ...	SEL_700G_1_LLNO_ST_Mo...	Write	4	0
SEL_700G_1_RB...	Octet64	5 Enable - On Data ...	SEL_700G_1_LLNO_CF_Mo...	Write	8	0
SEL_700G_1_RB...	Enum	6 Enable - On Data ...	SEL_700G_1_METXMMXU...	Write	9	0
SEL_700G_1_RB...	BOOLEAN	7 Enable - On Data ...	SEL_700G_1_METXMMXU...	Write	11	0
		8 Enable - On Data ...	SEL_700G_1_METXMMXU...	Write	13	0
		9 Enable - On Data ...	SEL_700G_1_RBGGIO1_ST...	Write	15	0
		10 Enable - On Data ...	SEL_700G_1_RBGGIO1_ST...	Write	16	0
		11 Enable - On Data ...	SEL_700G_1_RBGGIO1_ST...	Write	17	0
		12 Enable - On Data ...	SEL_700G_1_RBGGIO1_ST...	Write	18	0

2 Select or enter the command options for each tag by double-clicking the cell in the row. Note that you cannot edit the values in some columns.

Parameter	Description
Enable	<p>Select when the gateway executes the command.</p> <ul style="list-style-type: none"> ○ ENABLE ALL COMMANDS - CONTINUOUSLY causes the gateway to execute the command every time the gateway processes the command list. ○ ENABLE ALL COMMANDS - ON DATA CHANGE (Write command only) causes the gateway to execute the command only if the data to be written has changed. ○ DISABLED causes the gateway to ignore this command. <p>The default is ENABLE ALL COMMANDS - ON DATA CHANGE.</p>
Tag Name	This is the tag name for this IEC-61850 Data Attribute (automatically generated by the ProSoft MNET-61850 Configuration Manager). It cannot be edited.
MB Func	Select the Modbus Function code to be used. The default is WRITE , which uses Modbus Function Code 16. You can set this value can to READ , which is Modbus Function code 3. If set to Read, the gateway acts as a Modbus TCP/IP Client, and actively reads that tag from the PLC or PAC server.
MB Addr	This is the Modbus Address in the PLC or PAC where the gateway writes or reads the value for the tag. This parameter specifies the starting Modbus register address in the Modbus server device. For Schneider Electric devices, the MB Addr is automatically determined based upon the PLC WRITE START REGISTER (%MW) on the <i>Modbus TCP/IP Device Configuration</i> dialog box (see Setting Modbus TCP/IP Port Properties (page 39)). For Generic Modbus devices, you must enter the Modbus address for each tag (the default address is 1 for each mapped tag).
Poll Interval	This parameter specifies the minimum interval to wait between successive executions of a given command when the enable code has been set for continuous execution. The parameter is entered in 1/10th of a second. Therefore, if a value of 100 is entered for a command, the command executes no more frequently than every 10 seconds. If Poll Interval is 0, the command will be executed every time it is at the top of the command list.
Length	The number of values associated with this command. This is determined based upon the data type of the Data Attribute. For Schneider Electric devices, you cannot edit the Length field M340, Quantum, or Premium devices. For Generic Modbus devices, you can edit the Length field for both read and write commands.
Swap	<p>For write commands, this parameter defines if the data to be sent to the server is reordered before sending. For read commands, this parameter defines if the data received from the server is reordered storing in the gateway's database.</p> <p>This parameter is helpful when dealing with floating-point or other multi-register values, as there is no standard method of storage of these data types in Modbus devices. This parameter can be set to reorder the four bytes of each two-register data group received. This can be in useful when passing data to other applications. The available options are:</p> <ul style="list-style-type: none"> ○ No SWAP (Default): No change in the byte ordering. Order: 1-2-3-4. ○ SWAP WORD: The words are swapped. Order: 3-4-1-2. ○ SWAP WORD AND BYTE: The words are swapped then the bytes in each word are swapped. Order: 4-3-2-1. ○ SWAP BYTES: The bytes in each word are swapped. The words should be swapped only when using an even number of words. Order 2-1-4-3.

3 When ready, click **FILE > SAVE** to save the command configuration.

4.4.3 Viewing the Modbus Commands for a Device

Right-click on the M3400, Quantum, or Premium bubble in the *Network View* pane and choose **PLC MAP VIEW**. This function is not available for the Generic Modbus device (*Modbus-IDA*).

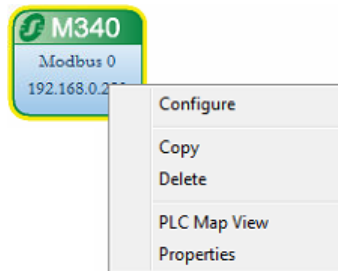

The *Map View* window gives you information about all of the tags mapped to this PLC or PAC.

Directi...	PLC Start MB Addr...	PLX Start MB Addr...	Tag Name	Size
MNET...	%MW0	1	SEL_700G_1_LLN0_ST_Mod_stVal_001	1
MNET...	%MW1	2	SEL_700G_1_LLN0_ST_Mod_stVal_002	1
MNET...	%MW2	3	SEL_700G_1_LLN0_ST_Mod_q_003	1
MNET...	%MW3	4	SEL_700G_1_LLN0_ST_Mod_t_004	4
MNET...	%MW7	8	SEL_700G_1_LLN0_CF_Mod_ctlModel_005	1
MNET...	%MW8	9	SEL_700G_1_METXMMXU1_MX_TotW_006	2
MNET...	%MW10	11	SEL_700G_1_METXMMXU1_MX_TotV_007	2
MNET...	%MW12	13	SEL_700G_1_METXMMXU1_MX_TotV_008	2
MNET...	%MW14	15	SEL_700G_1_RBGGIO1_ST_SPCS00_058	1
MNET...	%MW15	16	SEL_700G_1_RBGGIO1_ST_SPCS001_q_059	1
MNET...	%MW16	17	SEL_700G_1_RBGGIO1_ST_SPCS00_060	1
MNET...	%MW17	18	SEL_700G_1_RBGGIO1_ST_SPCS002_q_061	1
MNET...	%MW1000	1001	SEL_700G_1_RBGGIO1_CO_SPCS00_080	1
MNET...	%MW1001	1002	SEL_700G_1_RBGGIO1_CO_SPCS00_081	1
MNET...	%MW1002	1003	SEL_700G_1_RBGGIO1_CO_SPCS00_082	32
MNET...	%MW1034	1035	SEL_700G_1_RBGGIO1_CO_SPCS00_083	1
MNET...	%MW1035	1036	SEL_700G_1_RBGGIO1_CO_SPCS00_084	4
MNET...	%MW1039	1040	SEL_700G_1_RBGGIO1_CO_SPCS00_085	1

You cannot change any values in this window. If you want to change the values for any mapped Data Attributes, see *Modbus TCP/IP Commands* (page 42).

DIRECTION: This shows "MNET" with an arrow. It indicates in which direction the data will move.

- **MNET** → indicates the data is moving from the gateway's MNET Client to a remote Modbus TCP/IP server device (usually a Modicon PLC or PAC). This is IEC 61850 data being read from the IED and pushed from the gateway to the Modbus device.
- **MNET** ← indicates the data is moving from a remote Modbus TCP/IP Client device to the gateway's MNET server. This is mapped to IEC 61850 writable data. The Modbus device (usually a Modicon PLC or PAC) writes the data to the gateway, and the gateway writes it to the IED.

PLC START MB ADDRESS: This is the address in the PLC for the data. This is derived from the address configured in the *Modbus TCP/IP Device Configuration* window, **PLC READ START REGISTER (%MW)** or **PLC WRITE START REGISTER (%MW)** field. In Unity Pro addressing, **%MW1** means the same as Modbus 40,001 or 400,001 in common Modbus addressing.

PLX START MB ADDRESS: This is the address in the ProSoft gateway for the data.

TAG NAME: This is the tag name for this IEC-61850 Data Attribute (automatically generated by the ProSoft MNET-61850 Configuration Manager).

SIZE: This is the size of the data in words. The following chart shows the data size for the IEC-61850 data types when mapped to Modbus.

IEC 61850 Data Type	Number of Modbus Words	Modbus Data Type for Unity Pro	Size in Unity Pro
BOOLEAN	1	INT	1
INT8	1	INT	1
INT16	1	INT	1
INT24	2	INT	2
INT32	2	INT	2
INT128	Not Supported	Not Supported	Not Supported
INT8U	1	INT	1
INT16U	1	INT	1
INT24U	2	INT	2
INT32U	2	UDINT	1
FLOAT32	2	REAL	1
FLOAT64	Not Supported	Not Supported	Not Supported
Enum	1	INT	1
Dbpos	1	INT	1
Tcmd	1	INT	1
Quality	1	INT	1
Timestamp	4	INT	4
VisString32	51	INT	51
VisString64	51	INT	51
VisString255	51	INT	51
Octet64	32	INT	32
EntryTime	2	INT	2
Unicode255	51	INT	51
BitString	1	INT	1
Check	1	INT	1

To export the processor files

See Exporting Modbus Commands for a Device (page 46).

To print the processor files

Click **PRINT**.

See also:

Viewing Modbus TCP/IP Server Mapping (page 47)

Viewing Modbus TCP/IP Client Mapping (page 48)

4.4.4 Exporting Modbus Commands for a Device

After you have configured the Modbus TCP/IP commands for an M340, Quantum, or Premium Modbus device, you can export the XFM, XSY, and CSV configuration files. You can then import these files into Unity Pro.

Right-click on the M3400, Quantum, or Premium bubble in the *Network View* pane and choose **PLC MAP VIEW**. This function is not available for the Generic Modbus device (*Modbus-IDA*).

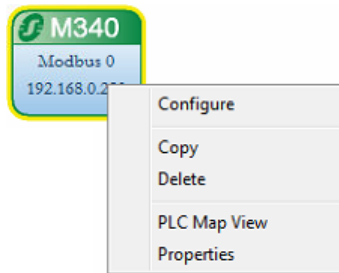

For descriptions of the columns in the *Map View* window, see Viewing the Modbus Commands for a Device (page 44).

Directi...	PLC Start MB Addr...	PLX Start MB Addr...	Tag Name	Size
MNET...	%MW0	1	SEL_700G_1_LLN0_ST_Mod_stVal_001	1
MNET...	%MW1	2	SEL_700G_1_LLN0_ST_Mod_stVal_002	1
MNET...	%MW2	3	SEL_700G_1_LLN0_ST_Mod_q_003	1
MNET...	%MW3	4	SEL_700G_1_LLN0_ST_Mod_t_004	4
MNET...	%MW7	8	SEL_700G_1_LLN0_CF_Mod_ctlModel_005	1
MNET...	%MW8	9	SEL_700G_1_METXMMXU1_MX_TotW_006	2
MNET...	%MW10	11	SEL_700G_1_METXMMXU1_MX_TotV_007	2
MNET...	%MW12	13	SEL_700G_1_METXMMXU1_MX_TotV_008	2
MNET...	%MW14	15	SEL_700G_1_RBGGIO1_ST_SPCS00_058	1
MNET...	%MW15	16	SEL_700G_1_RBGGIO1_ST_SPCS001_q_059	1
MNET...	%MW16	17	SEL_700G_1_RBGGIO1_ST_SPCS00_060	1
MNET...	%MW17	18	SEL_700G_1_RBGGIO1_ST_SPCS002_q_061	1
MNET...	%MW1000	1001	SEL_700G_1_RBGGIO1_CO_SPCS00_080	1
MNET...	%MW1001	1002	SEL_700G_1_RBGGIO1_CO_SPCS00_081	1
MNET...	%MW1002	1003	SEL_700G_1_RBGGIO1_CO_SPCS00_082	32
MNET...	%MW1034	1035	SEL_700G_1_RBGGIO1_CO_SPCS00_083	1
MNET...	%MW1035	1036	SEL_700G_1_RBGGIO1_CO_SPCS00_084	4
MNET...	%MW1039	1040	SEL_700G_1_RBGGIO1_CO_SPCS00_085	1

Map View window controls: Export Processor Files, Print, Close

In the *Map View* window, click **EXPORT PROCESSOR FILES**. The ProSoft MNET-61850 Configuration Manager prompts you for a location for the three export files:

- **A Variable file** (.XSY) that contains tag names and data types.
- **A Function Block file** (.XFM) that is only exported for M340, Quantum, or Premium devices (not used with the Generic Modbus device (*Modbus-IDA*)).
- **A Tag Names file** (.CSV) that lists tag names in a comma separated value file format.

Please note the following:

- Quantum processors with Ethernet ports can use the Function Block file (.XFM file) only if the processor is using firmware version 2.6 or later.
- If you use a NOE card for Ethernet connection between the Quantum PLC and the ProSoft gateway, the processor firmware version does not matter.

4.5 Viewing Modbus TCP/IP Server Mapping

Right-mouse-click on the **ProSoft Gateway** icon and choose **MODBUS TCP/IP SERVER MAPPING**. The *Modbus TCP/IP Server Mapping* window shows the location of all configured tags on the ProSoft gateway.

PLX Modbus Address	Tag Name	IEC Path
Project 1 - 40001	SEL_700G_1_LLNO_ST_Mod_stVal_001	LLN0\$ST\$Mod\$stVal
Project 1 - 40002	SEL_700G_1_LLNO_ST_Mod_stVal_002	LLN0\$ST\$Mod\$stVal
Project 1 - 40003	SEL_700G_1_LLNO_ST_Mod_q_003	LLN0\$ST\$Mod\$q
Project 1 - 40004	SEL_700G_1_LLNO_ST_Mod_t_004	LLN0\$ST\$Mod\$t
Project 1 - 40008	SEL_700G_1_LLNO_CF_Mod_ctiModel_005	LLN0\$CF\$Mod\$ctiModel
Project 1 - 40009	SEL_700G_1_METXMMXU1_MX_TotW_006	BR/BRep01:METXMMXU1\$MX\$TotW\$mag\$F
Project 1 - 40011	SEL_700G_1_METXMMXU1_MX_TotV_007	BR/BRep01:METXMMXU1\$MX\$TotV\$mag\$F
Project 1 - 40013	SEL_700G_1_METXMMXU1_MX_TotV_008	BR/BRep01:METXMMXU1\$MX\$TotV\$mag\$F
Project 1 - 40015	SEL_700G_1_RBGGIO1_ST_SPCSO0_058	GOOSE/GooseDSet13:RBGGIO1\$ST\$SPCSO01\$stVal
Project 1 - 40016	SEL_700G_1_RBGGIO1_ST_SPCSO01_q_059	GOOSE/GooseDSet13:RBGGIO1\$ST\$SPCSO01\$q
Project 1 - 40017	SEL_700G_1_RBGGIO1_ST_SPCSO0_060	GOOSE/GooseDSet13:RBGGIO1\$ST\$SPCSO02\$stVal
Project 1 - 40018	SEL_700G_1_RBGGIO1_ST_SPCSO02_q_061	GOOSE/GooseDSet13:RBGGIO1\$ST\$SPCSO02\$q
Project 1 - 41001	SEL_700G_1_RBGGIO1_CO_SPCSO0_080	RBGGIO1\$CO\$SPCSO01\$Oper\$ctlVal
Project 1 - 41002	SEL_700G_1_RBGGIO1_CO_SPCSO0_081	RBGGIO1\$CO\$SPCSO01\$Oper\$origin\$orCat
Project 1 - 41003	SEL_700G_1_RBGGIO1_CO_SPCSO0_082	RBGGIO1\$CO\$SPCSO01\$Oper\$origin\$orIdent
Project 1 - 41035	SEL_700G_1_RBGGIO1_CO_SPCSO0_083	RBGGIO1\$CO\$SPCSO01\$Oper\$ctlNum
Project 1 - 41036	SEL_700G_1_RBGGIO1_CO_SPCSO0_084	RBGGIO1\$CO\$SPCSO01\$Oper\$T
Project 1 - 41040	SEL_700G_1_RBGGIO1_CO_SPCSO0_085	RBGGIO1\$CO\$SPCSO01\$Oper\$Test
Project 1 - 41041	SEL_700G_1_RBGGIO1_CO_SPCSO0_086	RBGGIO1\$CO\$SPCSO01\$Oper\$Check

- **PLX MODBUS ADDRESS:** This starts with the Project Name, hyphen, followed by the Modbus Address of the tag in the gateway. Your Modbus TCP/IP Client can fetch this data from this location in the gateway.
- **TAG NAME:** This is the tag name for the data, as referenced by the ProSoft gateway.
- **IEC PATH:** This is the original source path of the data from the IED.

4.6 Viewing Modbus TCP/IP Client Mapping

Right click on the **ProSoft Gateway** icon and choose **MODBUS TCP/IP CLIENT MAPPING**. The *Modbus TCP/IP Client Mapping* window shows the entire mapping of the Modbus TCP/IP Client gateway.

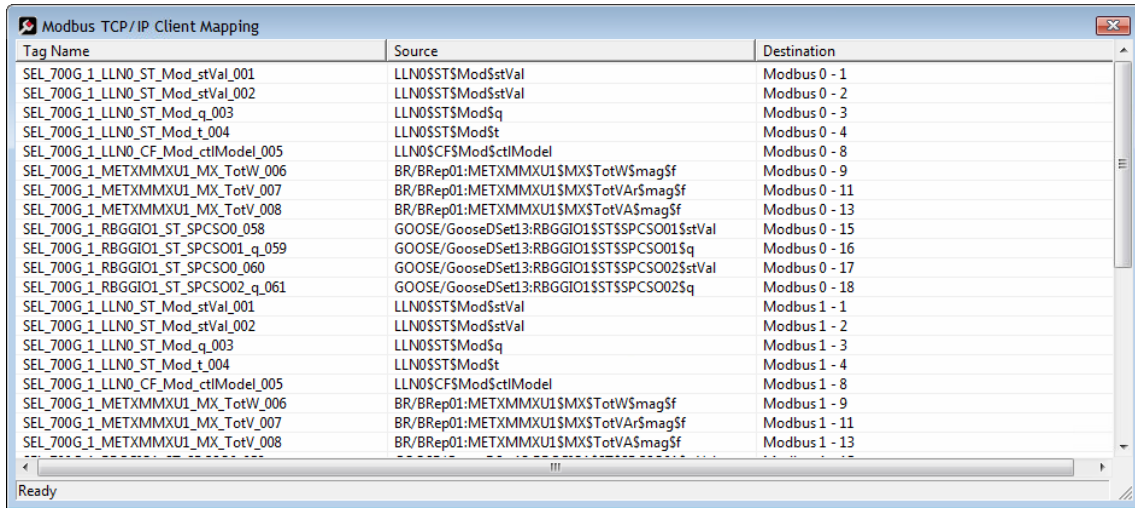

- **TAG NAME:** These are the tag names. By default they are prefixed with the IED name.
- **SOURCE:** This is the IED source path of the data.
- **DESTINATION:** In this example the destinations are on two different Modbus devices, Modbus 0 and Modbus 1. The PLC or PAC Starting Modbus Address is appended to the end of the Modbus device names.

5 Configuration File Management

5.1 Validating the Configuration

You can validate the configuration file before downloading it to the gateway.

- 1 Right-click the *Project* bubble and choose **DOWNLOAD FROM PC TO DEVICE**.

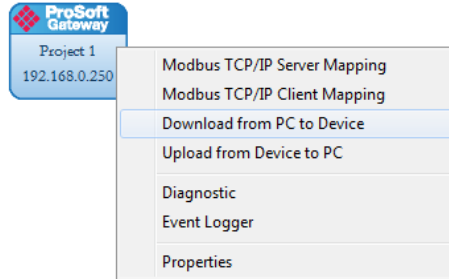

This displays the *Transfer File* dialog box.

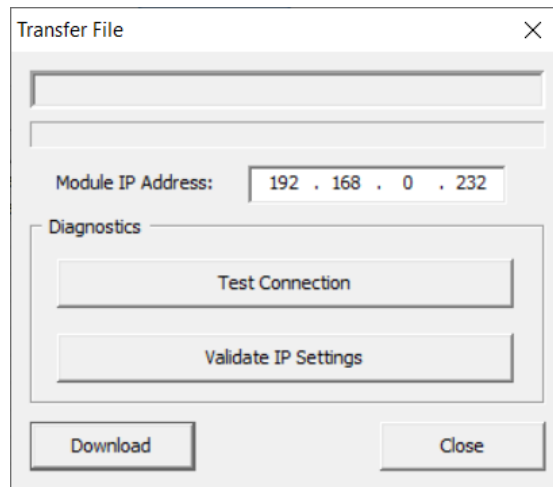

- 2 Click **VALIDATE IP SETTINGS**.

5.2 Downloading the Configuration File to the Gateway

After you have created the IEC 61850 project in the Configuration Manager software, you are ready to download it to the gateway.

Note: If you want to validate the configuration before downloading, refer to Validating the Configuration (page 49).

- 1 Right-click the *Project* bubble and choose **DOWNLOAD FROM PC TO DEVICE**.

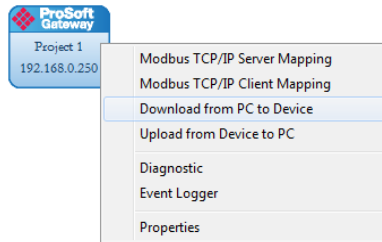

This displays the *Transfer File* dialog box.

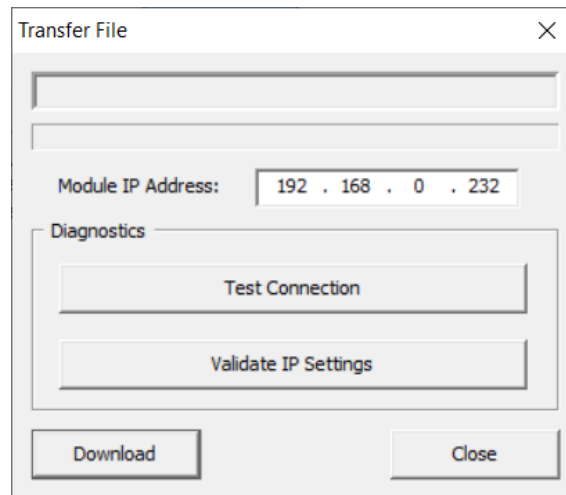

- 2 Click **TEST CONNECTION**. If the gateway's IP address does not match what was entered in ProSoft MNET-61850 Configuration Manager, then the software displays an error message:
"Error: Connecting to Module. Please check your IP Address."
If the gateway's IP address matches the address in the Configuration Manager, and the software displays the following message: "Successfully Connected."
- 3 Click **DOWNLOAD** to download the project to the gateway.

5.3 Uploading the Configuration from the Gateway

You can use this feature to retrieve the configuration from the gateway. Not only does it retrieve the configuration, but it also retrieves all the CID, ICD, and/or SCD files used in creating that configuration. There are several reasons that you might use this feature:

- You want to modify the configuration, but do not have access to the original configuration files.
- You want to copy a configuration from one gateway to another gateway.
- You want to back up the configuration for safety.

Warning: This function replaces the current configuration in the ProSoft MNET-61850 Configuration Manager with the one from the gateway. Make sure you save the current configuration before uploading the configuration from the gateway.

- 1 Optional: Create a new project in the ProSoft MNET-61850 Configuration Manager by choosing **FILE > NEW**.
- 2 Right-click the *ProSoft Gateway* bubble and choose **UPLOAD FROM DEVICE TO PC**.

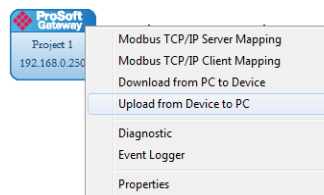

The Configuration Manager uploads the configuration from the gateway and displays it. You can then edit the configuration or save it on the computer.

5.4 Exporting a Project from the Configuration Manager

You can export a ProSoft MNET-61850 Configuration Manager file that you created on your PC. Exporting a project includes all the original IED files that you used to create the project into the export file. This allows someone on a different PC to import your configuration file and have all the CID/SCD/ICD files that are part of your project. If you need assistance from ProSoft Technology Technical Support, they will need your configuration file.

- 1 In the ProSoft MNET-61850 Configuration Manager, choose **FILE > EXPORT CONFIGURATION**.
- 2 In the *Save As* dialog box, navigate to the correct directory and save the configuration file.

Note: You can also upload the configuration from the gateway, and then save it to a file. Refer to *Uploading the Configuration from the Gateway* (page 51).

5.5 Importing Updated IED Files

You may need to make changes to the CID, ICD, or SCD files after you create the IED system configuration in the gateway. For example, you may need to modify a DATA-SET, or add or remove some Data Attributes. When you make changes like this, it's easy to update the project in the ProSoft MNET-61850 Configuration Manager with the new information.

- 1 Right-mouse-click on the **CID, SCD, OR ICD** filename you want to update in the *Device View* section of the ProSoft MNET-61850 Configuration Manager and choose **UPDATE IED**.

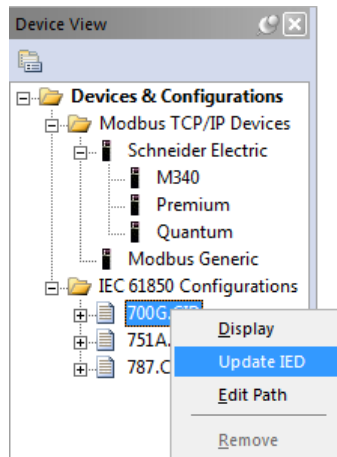

- 2 In the *Open* dialog box, browse to the directory containing the ICD, CID, or SCD file. The same filename is often used as when you first imported the file into the ProSoft MNET-61850 Configuration Manager.

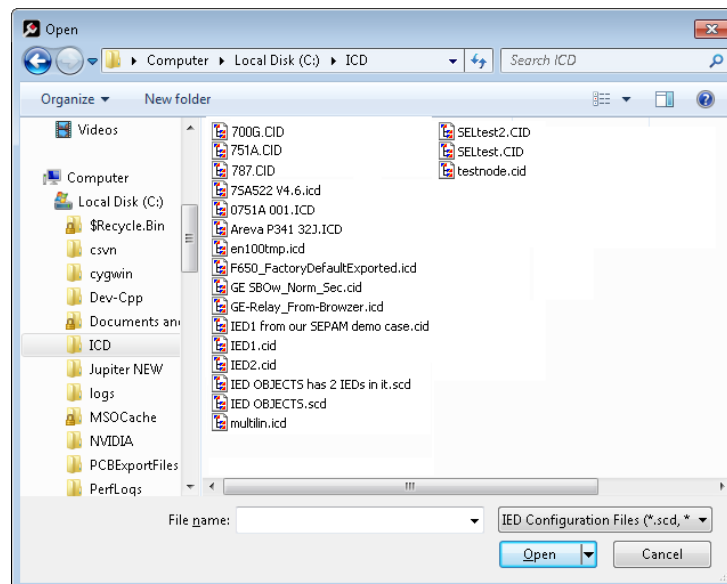

When you right-click the *IEC 61850* bubble representing that IED and choose **CONFIGURE**, the *IEC 61850 Mapping Tool* window shows the previously configured tags. If any of the previously configured Data Attributes for that IED are now missing from the new CID, SCD, or ICD file that you just imported, then those tags are highlighted in red. This lets you know that they are not in the updated IED file.

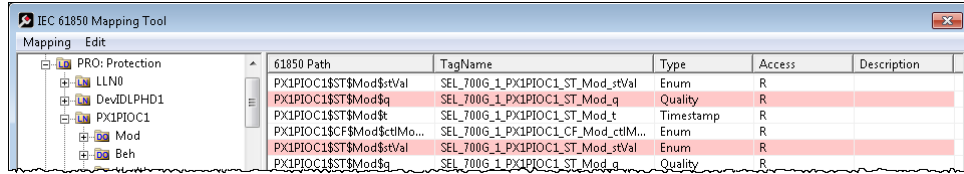

- 3 Right-click the missing tag and choose **DELETE**. This removed the tag mapping for the IED. Any corresponding mappings on the Modbus TCP/IP side of the Gateway are also deleted.
- 4 When you have finished updating the mapping, choose **MAPPING > SAVE** to save the changes.
- 5 Download the updated project to the gateway.

6 Configuring the Quantum Processor with Unity Pro

6.1 Configuring the Quantum Hardware

There are two steps to configuring the Quantum hardware:

- 1 Creating a new Unity Pro project and picking the CPU type.
- 2 Adding a power supply.

6.1.1 Create a new Unity Pro Project

- 1 The first step is to open Unity Pro and create a new project. In the *New Project* dialog box, choose the **CPU TYPE**.

In the following illustration, the CPU is 140 CPU 651 60. Select the processor type that matches your own hardware configuration.

- 2 Click **OK** to continue.

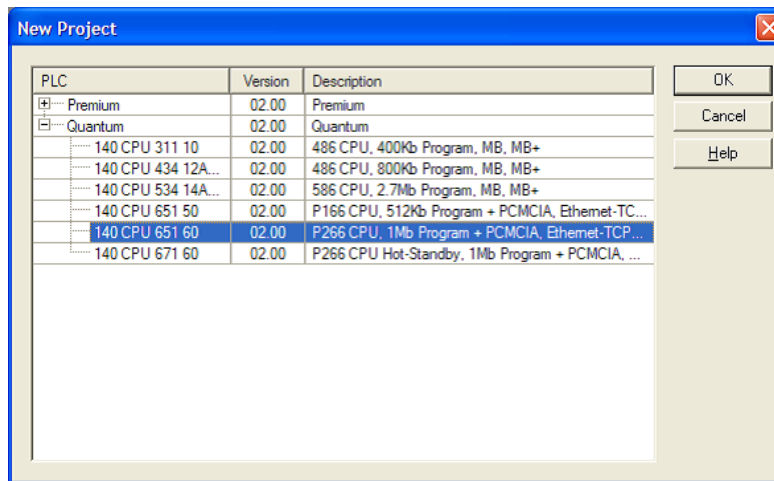

6.1.2 Adding a Power Supply

- 1 In the *Project Browser*, expand the **CONFIGURATION** folder, and then double-click the **1:LOCALBUS** icon. This opens a graphical window showing the arrangement of devices in your Quantum rack.

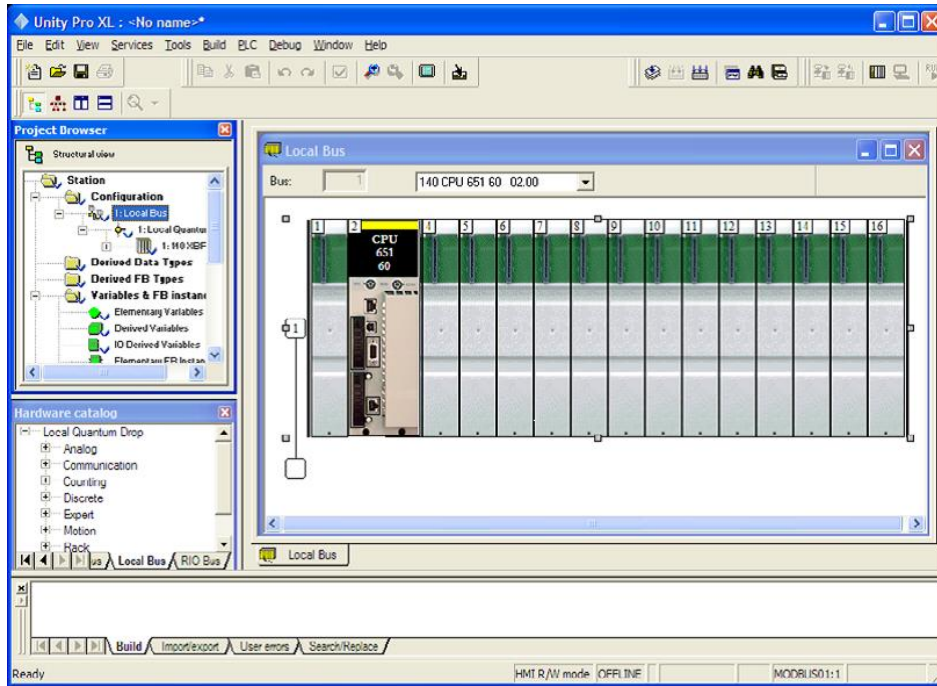

- 2 Right-click the rack position for the power supply, and then click the right to open a shortcut menu.
- 3 On the shortcut menu, choose **NEW DEVICE**.

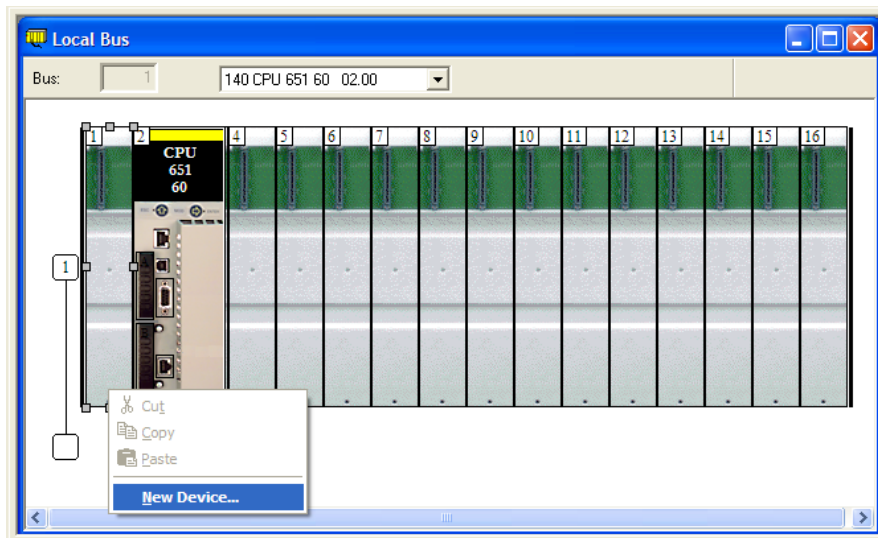

- 4 In the *New Device* dialog box, expand the **SUPPLY** folder. Select the power supply from the list.

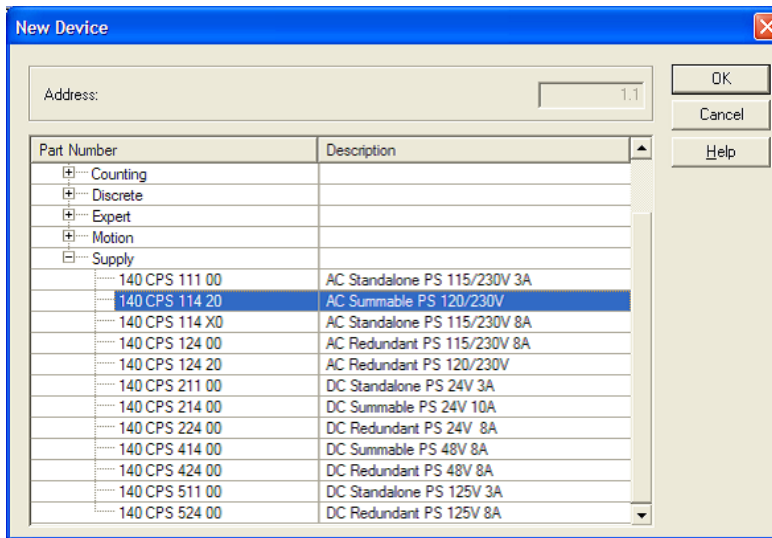

- 5 Click **OK** to close the dialog box.

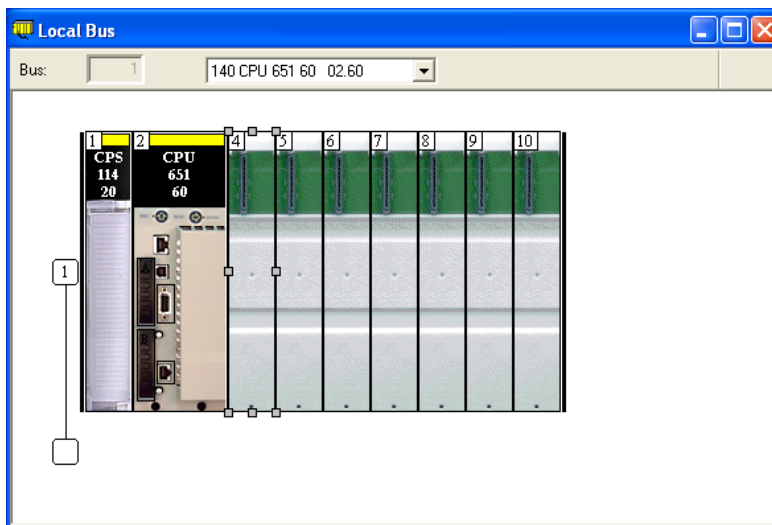

6.2 Importing the Quantum Functional Module (.XFM File)

To simplify the task of programming the processor when communicating with the ProSoft gateway, the ProSoft MNET-61850 Configuration Manager can export a Unity Pro Functional Module file (XFM). See Exporting Modbus Commands for a Device (page 46).

Note: The Functional Module file is intended to be used only for new ProSoft gateway installations. If you already have an existing installation, the following procedure will overwrite all settings, and may cause loss of functionality. DO NOT use this procedure to overwrite a working application until you have thoroughly reviewed the rest of the topics in this manual.

- 1 In Unity Pro, choose **VIEW > FUNCTIONAL VIEW**.

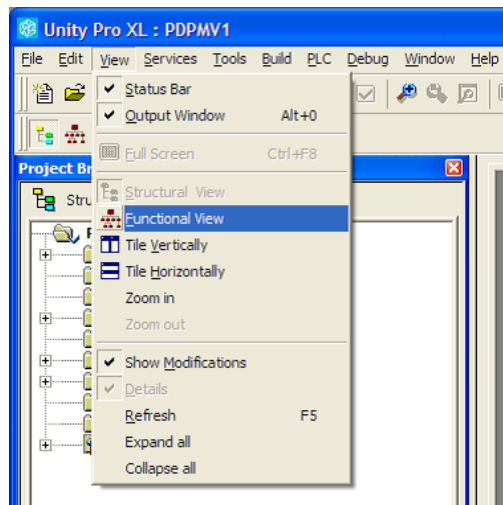

This populates the *Project Browser* with a **FUNCTIONAL PROJECT** icon.

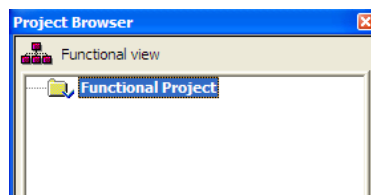

- 2 Right-click **FUNCTIONAL PROJECT**, and then choose **IMPORT**.

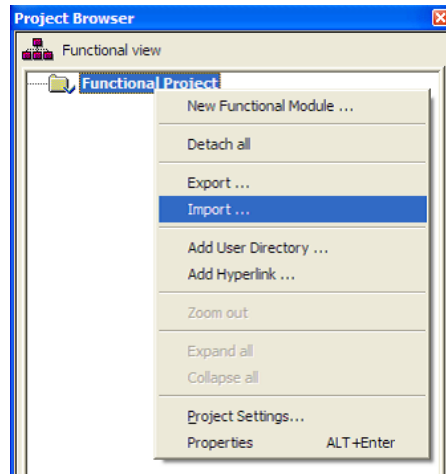

- 3 Choose **No** if the software asks you to save the changes.

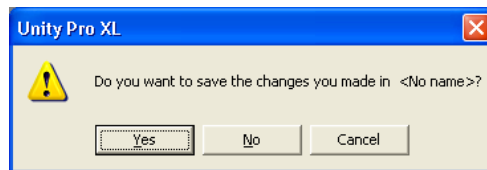

- 4 In the *Import* dialog box, in the **FILES OF TYPE** list, choose **FUNCTIONAL MODULE (*.XFM)**, and then select the XFM file to import. Choose the XFM file that you created using the ProSoft MNET-61850 Configuration Manager.

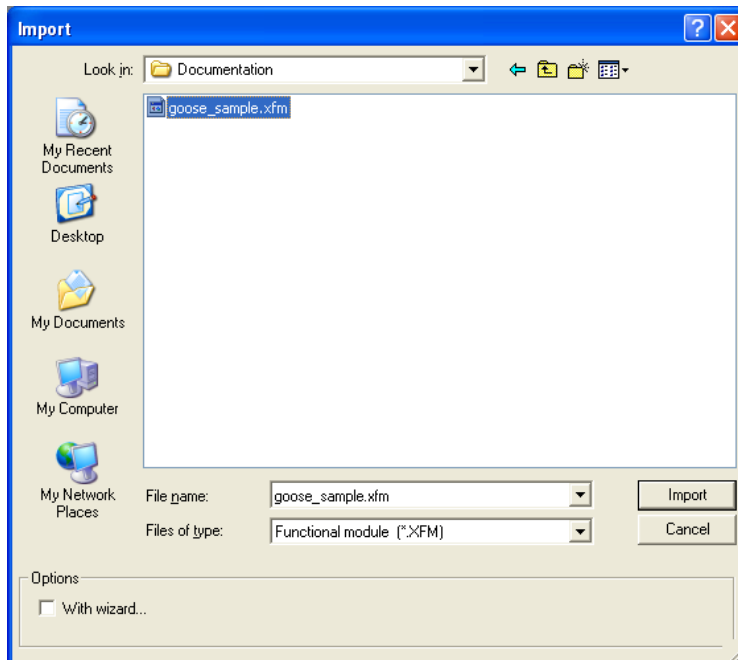

- 5 Click **IMPORT** to import the file. The software populates the *Project Browser* with the information from the Functional Module file.

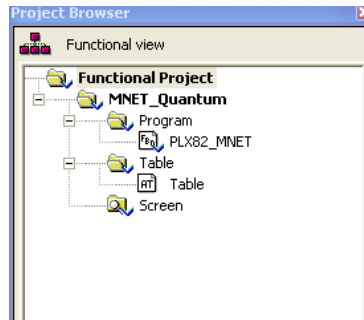

6.3 Importing the Quantum Variable File (.XSY File)

- 1 In Unity Pro, choose **VIEW > STRUCTURAL VIEW**.
- 2 Right-click **VARIABLE AND FB INSTANCES**, choose **IMPORT**.

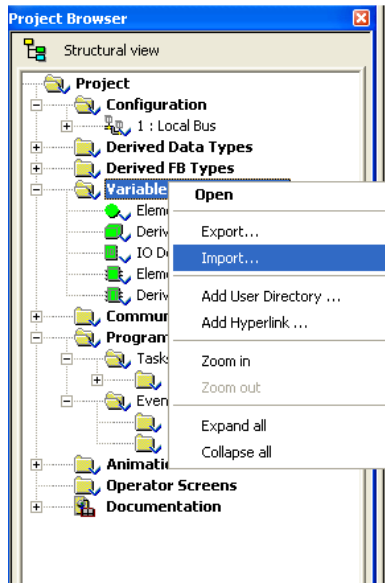

- 3 Choose **No** if the software asks you to save the changes.

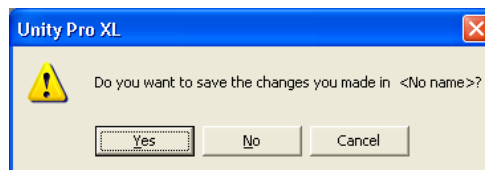

- 4 In the **FILES OF TYPE** list, choose **DATA EXCHANGE FILE (*.XSY)**. Select the XSY file you exported from the ProSoft MNET-61850 Configuration Manager, and then click **IMPORT**.

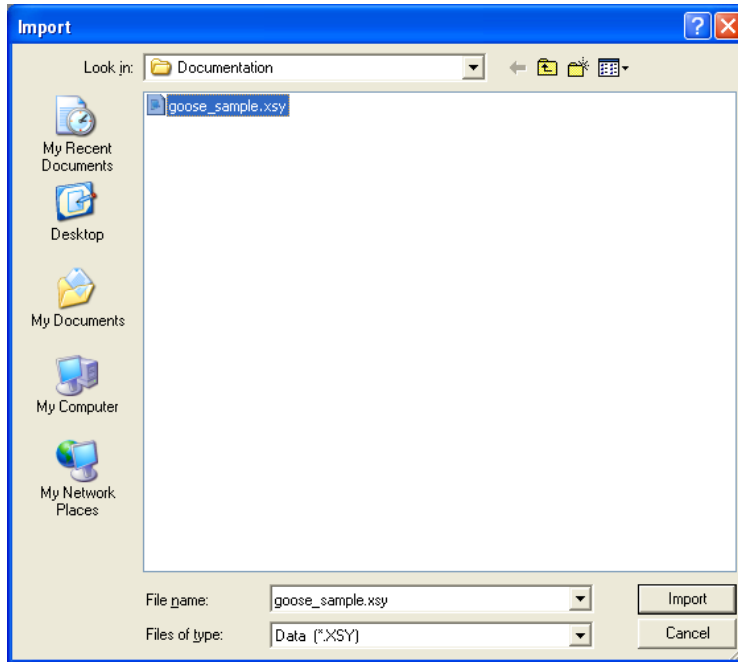

- 5 In the *Project Browser*, double-click **VARIABLES AND FB INSTANCES**.

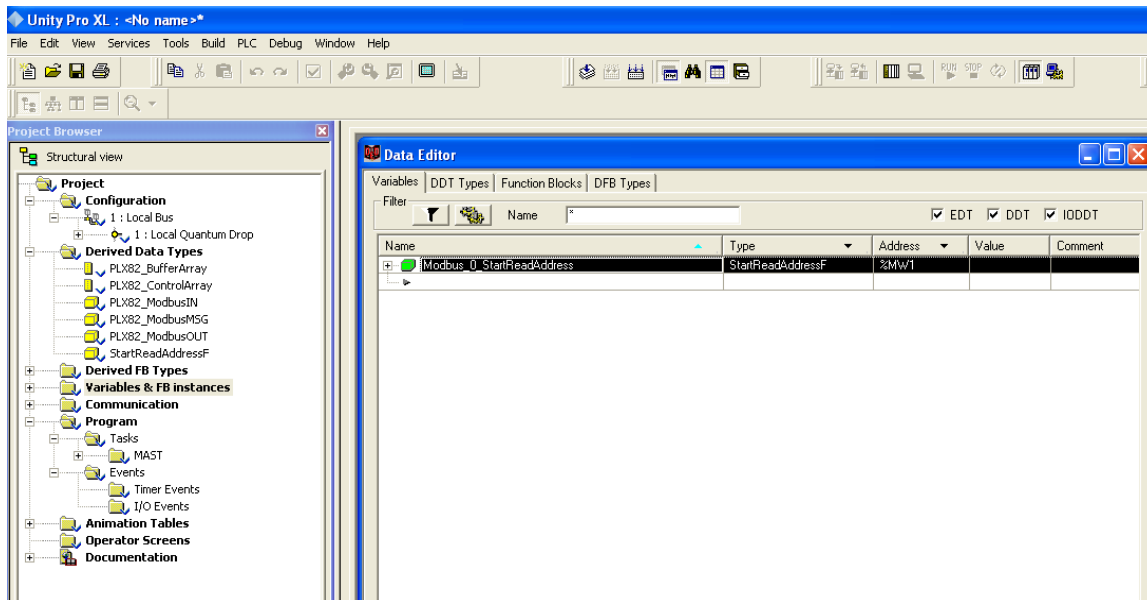

- This opens the *Data Editor* dialog box. Expand the variables to see the tags that were generated by the ProSoft MNET-61850 Configuration Manager.

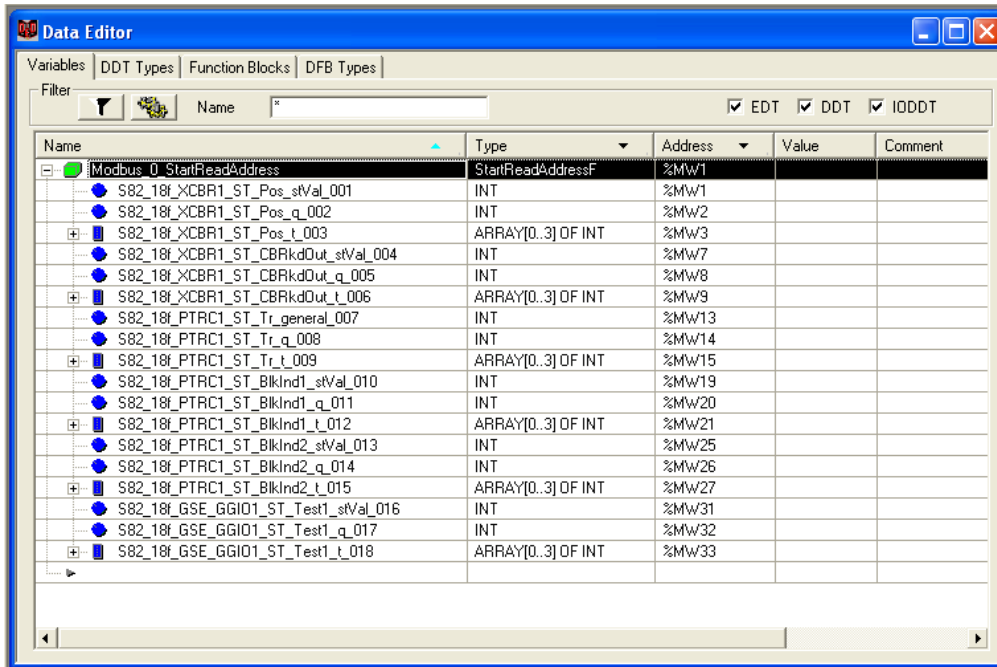

6.4 Completing the Quantum Configuration

For the next step, complete the configuration of the project, such as adding any other modules in the rack.

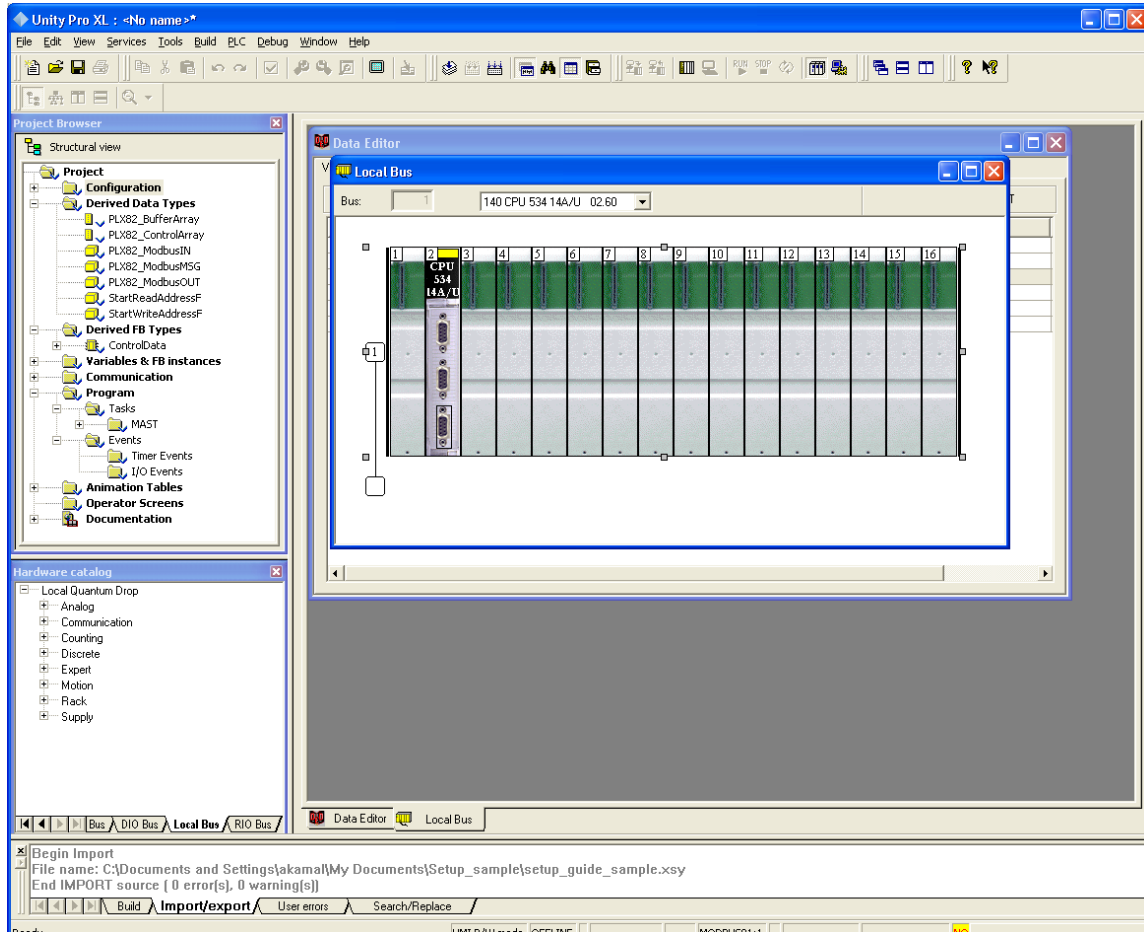

Once you complete the rack configuration, you can verify the data transfer. In order to verify data transfer, you must build the project, download it to the processor, and then place the processor in *Run* mode.

6.5 Verifying the Data Transfer

Once you have configured the Quantum configuration, you can verify that the data is transferring to and from the gateway. In the *Project Browser*, double-click **VARIABLES AND FB INSTANCES**.

In the *Data Editor* dialog box, the table shows the IP address for the ProSoft gateway.

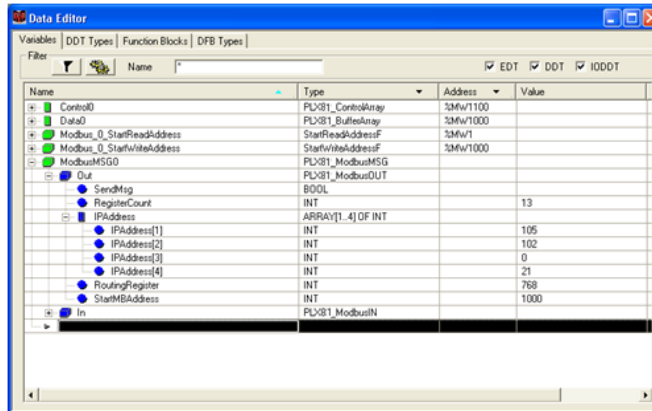

If it is configured correctly, then the table should show the voltage value we are trying to send from the IED to the PLC.

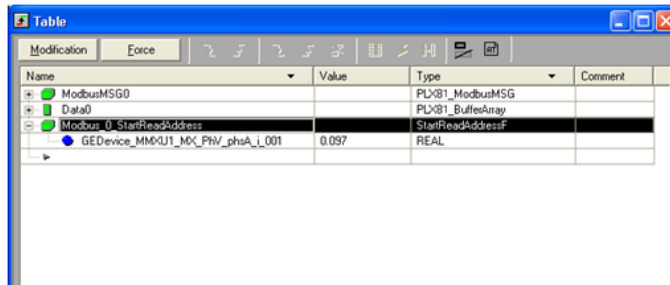

7 Diagnostics and Troubleshooting

There are two ways to troubleshoot this PLX82-MNET-61850 gateway:

- Use the LEDs located on the front of the gateway.
- Use the Debug port (Ethernet port E1) that provides a view into the gateway's internal database.

7.1 Known Anomalies

In the unlikely event that an IED on the network causes a large number of reconnects to the gateway, the 61850 driver in the gateway eventually restarts, causing re-initialization of the communication between the gateway and all the IEDs on the network. Until all the IEDs connected on the network have been reinitiated, the data in the gateway database being transferred through the gateway's Modbus TCP/IP is not being updated. To help you detect this condition, there are status bits available that you can effectively use in the program in the PLC for tracking. Refer to Driver Status Data (page 66).

7.2 Important Design Considerations

When utilizing any type of gateway device, take care to make sure that in the event in loss of communications between devices on either driver in the gateway (the 61850 driver to the IEDs or the Modbus TCP/IP driver to the processor), this loss of communications is passed to the other driver.

For example, suppose there is a loss of communications with an IED device on the 61850 network. This information is shared with the Modbus TCP/IP device, so that the device can make an informed decision to trigger any type of alarm or fail safe state for the attached device.

All applications should also consider each of the status words available to the various drivers. No application should be configured into a live system without mapping the driver status words and IEC 61850 IED status registers as described in Driver Status Data (page 66).

Reporting this status information is crucial to the set-up and configuration of a live system. Without mapping status data to the various drivers, it is impossible to tell if communications is actively occurring with the device, or if the data values are stale, and simply represent the last known conditions of that device before the communication failure.

Driver status, IED status, and client/server status information should be shared with the various drivers to ensure that a clear indication of the loss of communications can be signaled to the devices on the network.

7.3 LEDs

LED	State	Description
Pwr	OFF	Power is not connected to the power terminals or source is insufficient to properly power the gateway (800mA at 24 VDC minimum required)
	Solid GREEN	Power is connected to the power terminals. Verify that the other LEDs for operational and functional status come on briefly after power-up (check for burned-out LEDs).
Flt	OFF	Normal operation
	Solid RED	A critical error has occurred. Program executable has failed or has been user-terminated and is no longer running. Press Reset p/b or cycle power to clear error.
Cfg	OFF	Normal operation
	Solid AMBER	The unit is in configuration mode. The configuration file is currently being downloaded or, after power-up, is being read, the unit is implementing the configuration values, and initializing the hardware. This occurs during power cycle, or after pressing the reset button. It also occurs after a cold/warm boot command is received.
Err	OFF	Normal operation
	Flashing	An error condition has been detected and is occurring on one of the application ports. Check configuration and troubleshoot for communication errors.
	Solid AMBER	This error flag is cleared at the start of each command attempt (client) or on each receipt of data (server); so, if this condition exists, it indicates a large number of errors are occurring in the application (due to bad configuration) or on one or more ports (network communication failures).
Data	OFF	No activity on the Ethernet port.
	Flashing GREEN	The Ethernet port is actively transmitting or receiving data.
Link	OFF	No physical network connection is detected. No Ethernet communication is possible. Check wiring and cables.
	Solid GREEN	Physical network connection detected. This LED must be on solid for Ethernet communication to be possible.

7.4 Driver Status Data

These are the status registers in the ProSoft gateway:

Driver	Gateway DB Address
NTP	65530
MNET Client	65531
MNET Server	65532
IEC-61850	65533
Reboot	65534

The Driver Status Registers possible values are:

1 = Ok

0 = Failed or Driver startup/restart is occurring

These are the 61850 IED status registers in the gateway:

Gateway DB Address	Description
65450	Node 0 status
65451	Node 1 status
65452	Node 2 status
...	...
65494	Node 44 status
65495	Reconnect count

Possible values are:

1 = Node connected

0 = Node initializing

-1 = Node disconnected. It may take up to 15 minutes to show this, and will first show as "-2".

-2 = Node in error

7.5 Rebooting the Gateway

If you need to reboot the ProSoft gateway, there are a few ways to do it:

- Disconnect and reconnect power from the gateway.
- From the PLC or generic Modbus device, write to the gateway's address 65535.
- From the webpage on the ProSoft gateway, use the Reboot Gateway command.

Note: The ProSoft gateway reboots automatically after you download a new configuration file.

7.6 ProSoft EIP-61850 Tag Monitor Diagnostics

To start ProSoft EIP-61850 Tag Monitor, select **Start > Programs > ProSoft Technology > ProSoft EIP-61850 Tag Monitor**.

ProSoft EIP-61850 Tag Monitor requests the gateway's IP address upon start-up.

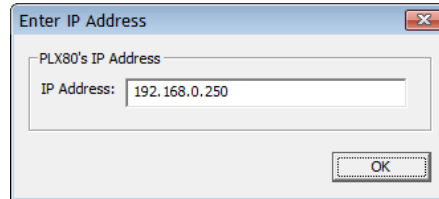

Once ProSoft EIP-61850 Tag Monitor locates the gateway, it shows information about the tags in the gateway's tag database. ProSoft EIP-61850 Tag Monitor allows you to change the values of a tag through the *Value* field. Data movement from the devices connected to the gateway may overwrite any values that were provided on this window.

Here is the ProSoft EIP-61850 Tag Monitor window.

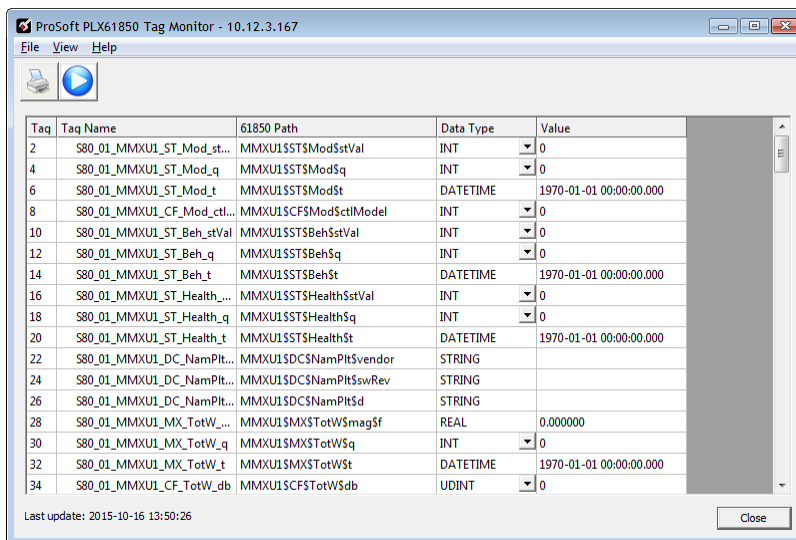

The window shows three columns of data: **TAG NAME**, **DATA TYPE**, and **VALUE**. Tag names for complex data types show a + to the left of the name. The gateway considers some of the IEC 61850 data types to be complex. In the window shown here, see Tag Name S40_1r_RREC1_CO_BlKRec_Oper_003.

In this example, this Tag Name is mapped to IEC 61850 Path RREC1\$CO\$BlKRec\$Oper\$origin\$orIdent. The IEC 61850 Standard identifies *orIdent* as the originator identification, and shows the address of the originator who caused the change of the value. Data for which there are several levels of hierarchy are considered complex, as well as some longer data types. The data type orIdent is Octet64.

To print the data:

Click the Print button to print the current data.

To start/stop data update:

Click the Start/Stop button to start or stop updating the data. Note that the appearance of this button changes when you toggle between start and stop.

Note: All Tag Monitor functions require that you install the MODE 3 jumper on the module. Refer to Jumper Setting (page 8).

7.7 ProSoft 61850 Configuration Manager Diagnostics

7.7.1 IEC 61850 Client Diagnostics

The following sets of IEC 61850 client diagnostics data are available from the gateway:

- Configuration Settings
- Driver Status
- Remote Node Config
- Remote Node Status
- Report Status
- GOOSE Subscription Status

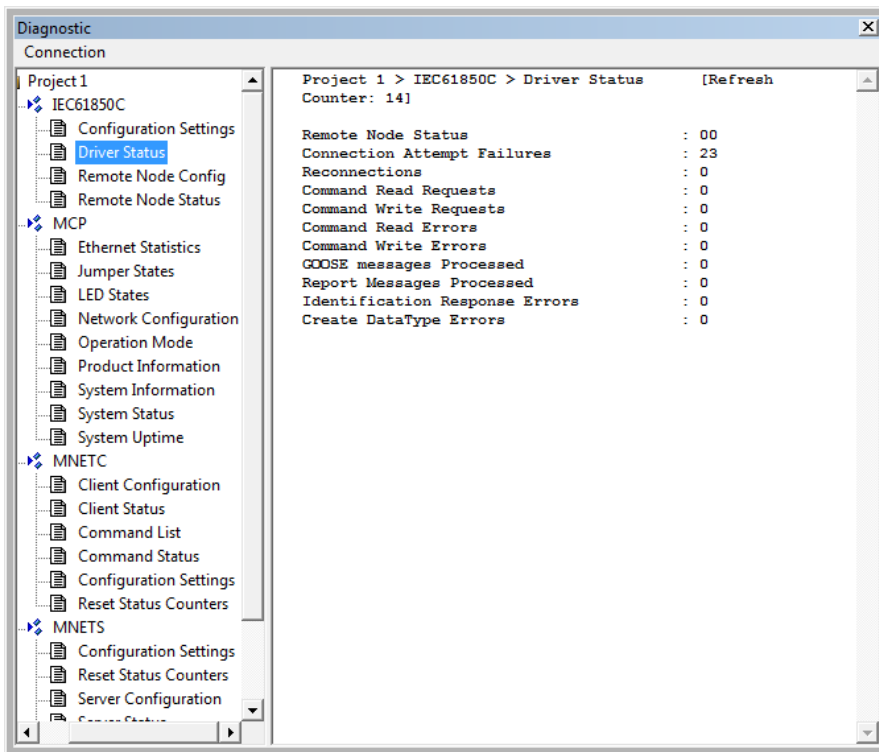

Configuration Settings

The following Configuration Settings diagnostic data is available from the gateway.

Value	Description
Configured Communications Port	ETH 1 or ETH 2
GOOSE Support	TRUE or FALSE value, indicating if GOOSE messaging is supported and configured on the gateway
Sampled Values Support	TRUE or FALSE value, indicating is Sampled Values is supported and configured on the gateway
Number of Remote Addresses	The count of remote addresses present in the current operating configuration of the gateway, in the IEC-61850 driver
Reports Configured	TRUE or FALSE value in driver indicating if reports are currently configured in the IEC-61850 driver
Number of Commands	The total count of Read and Write commands present in the current operating configuration of the IEC-61850 driver
Number of GOOSE Subscriptions	The total count of GOOSE subscriptions present in the current operating configuration of the IEC-61850 driver
Number of Reports Configured	The total count of reports (Buffered and Unbuffered) present in the current operating configuration of the IEC-61850 driver

Driver Status

The following Driver Status diagnostic data is available from the gateway.

Value	Description
Remote Node Status	Bitmap of 1s or 0s, to indicate the communication status of each IED where 1=communication is good, and 0=no communication.
Connection Attempt Failures	The count of connection failures with the remote device.
Reconnections	The count of connections after a communication failure.
Command Read Requests	The count of total IEC61850 (MMS type) read command requests sent to nodes defined in the configuration file.
Command Write Requests	The count of total IEC61850 (MMS type) write command requests sent to nodes defined in the configuration file.
Command Read Errors	The count of total IEC61850 (MMS type) read errors received from requests sent to nodes defined in the configuration file.
Command Write Errors	The count of total IEC61850 (MMS type) write errors received from requests sent to nodes defined in the configuration file.
GOOSE Messages Processed	The total count of GOOSE messages received per all subscriptions defined in the current 61850 driver configuration.
Report Messages Processed	The total count of reports received per all reports that are enabled, and present in the current 61850 driver configuration.
Identification Response Errors	The total count of Identification response errors per the nodes/devices defined in the current 61850 driver configuration.
Create DataType Errors	The total count of errors received when making a request for datatypes defined for the configured commands in the current 61850 driver configuration.

Remote Node Config

Command	Description
Remote Node Configured Index, or (Not Configured)	Value is the current index used of the addressed node, indicating that the node is configured in the current operating configuration file... or the value indicates that the node is not configured.
Remote Node IP Address	The IP Address of the indexed node being requested that is defined in the configuration file.
Remote Node Name	The Node Name identifier of the indexed node being requested that is defined in the configuration file.
Interscan Delay	The time between executions of the command for an MMS tag.
MMSping	The rate at which the gateway will ping the IED Server. This is used to maintain an open communications connection, particularly when the gateway has only GOOSE messages configured.
General Timeout (default)	Timeout, measured in seconds, between all client and server communication, except for timeouts specified for <i>Command-Termination Timeout</i> and <i>Connect/Disconnect Timeout</i> .
CmdTerm Timeout (default)	Timeout, measured in seconds, for 61850 control operation issued against a point whose control model is "with enhanced security" (either "direct" or "SBO").
Connect/Disconnect Timeout	Timeout, measured in seconds, for establishing a 61850-protocol TCP/IP connection between client and server.

Commands Configured

Command Index Entry(s)	Lists the commands defined in the config file for the indexed node being requested, where each command entry is defined with this start tag to identify the command with a unique entry index used.
Command Domain Name	Identifies the Domain Name used when accessing the 61850 variable via the command entry index in the returned information.
Command Datapath Name	Identifies the Datapath Name used when accessing the 61850 Data Attribute via the command entry index in the returned information.
General Timeout	Timeout, measured in seconds, between all client and server communication, except for timeouts specified for <i>CmdTerm Timeout</i> .
CmdTerm Timeout	Timeout, measured in seconds, for 61850 control operation issued against a point whose control model is "with enhanced security" (either "direct" or "SBO").
Command Tagname(s)	Identifies the gateway's tagnames for the command, which are allocated in the configuration file for the indexed command entry.
GOOSE Index Entry(s)	Lists the GOOSE subscriptions defined for requested indexed node, where each GOOSE subscription is defined with this tag to identify the GOOSE subscription unique entry index.
Data Set Reference	Identifies the DATA-SET Reference used when receiving the GOOSE message.
GOOSE CB Reference	Identifies the GOOSE Control Block Reference used on the remote node for this specific GOOSE Subscription indexed entry.
Application ID	Identifies the Application ID used on the remote node for this specific GOOSE subscription indexed entry.
Multicast Address	Identifies the Multicast Address used on the remote node for this specific GOOSE subscription indexed entry.
Configuration Revision	Identifies the Configuration Revision used on the remote node for this specific GOOSE subscription indexed entry.

Decode Mode	Identifies the Decode Mode used on the remote node for this specific GOOSE subscription indexed entry. Implemented to use Decode Mode Immediate.
GOOSE Domain Name Entry	The domain name entry for each of the data objects specified in the DATA-SET used by the GOOSE subscription.
GOOSE Data Ref Entry(s)	The data reference entry for each of the data objects specified in the DATA-SET used by the GOOSE subscription.
Report Index Entry(s)	Lists the reports defined in the configuration file for indexed node being requested, where each report is defined with this start tag to identify the report with a unique entry index.
Report Domain Name Entry	The domain name entry for the report control block specified along with the DATA-SET used by the report, in order to accurately decode the reported message to the ProSoft module's Tag Database Tags.
Report Data Reference Entry	The data reference entry for the report control block specified along with the DATA-SET used by the report, in order to accurately decode the reported message to the Tag Database.
Report ID	The report ID associated with this Report Entry.
# of Tags Associated w/ Report	The number of tags associated with this report entry in the Tag database.

Remote Node Status

Command	Description
Remote Node Status	Indicates if the remote node for this index is configured or not. If the remote node is configured the unique index is included to indicate the reference start of the following for the status information.
Remote Node IP Address	The IP Address used by the remote node for this index.
Remote Node Name	The remote node name used by the remote node for this index.
Remote Node Vendor	The Vendor that manufactures the remote node for this index.
Remote Node Model	The Model Number used by the remote node for this index.
Remote Node Revision	The revision used by the remote node for this index.
Remote IED Command Status	Lists the commands by individual unique index as corresponding to the current operating configuration in the gateway, in which the following data are returned to indicate the command status.
Command Status Entry	Lists the commands by individual unique index as corresponding to the current operating configuration in the ProSoft module, in which the following data are returned to indicate the command status.
Current Command Status	Indicates the last available status of the command sent to the remote node and the result, being either "OK" or "ERR".
Command Total Error Count	Indicates the total error count for this unique command as it was processed by the IEC-61850 drive.

Report Status

Command	Description
Command Status Entry(s) LIST...	Lists the commands by individual unique index as corresponding to the current operating configuration in the ProSoft module, in which the following data are returned to indicate the command status.
Current Command Status	Indicates the last available status of the command sent to the remote node and the result, being either "OK" or "ERR".
Command Total Error Count	Indicates the total error count for this unique command as it was processed by the IEC-61850 drive.
Report Status Entry(s) LIST...	Lists the reports by individual unique index as corresponding to the current operating configuration, in which the following data are returned to indicate the report received count.
Report Status Entry	Lists the report control block status by individual unique index as corresponding to the current operating configuration.
Reports Received Count	Indicates the total report received count for this unique report as it was processed by the PLX8x IEC-61850 driver.

GOOSE Subscription Status

Command	Description
GOOSE Status Entry	An individual unique index as corresponding to the current operating configuration, in which the following data are returned to indicate the GOOSE Message received count.
Goose Messages Received Count	Indicates the total GOOSE message received count for this unique GOOSE subscription as it was processed by the IED 61850 driver. It has been observed that sometimes this number shows fewer than expected.

7.7.2 MCP Diagnostics

The following MCP (internal gateway) diagnostic data is available from the gateway:

- Ethernet Statistics
- Jumper States
- LED States
- Network Configuration
- Operation Mode
- Product Information
- System Information
- System Status
- System Uptime

Ethernet Statistics

Function	Description
RX Bytes	Total received byte count
RX Packets	Total number of received Ethernet packets
TX Bytes	Total number of transmitted bytes
TX Packets	Total number of transmitted Ethernet packets

Jumper States

Jumper Name	States
Setup	ON or OFF. Note: While this jumper is removed 'OFF', all webpages are disabled on the module. It is recommended that the setup jumper be removed for normal operation, as webpage activity may interfere with communications.
Default IP	ON or OFF
Reserved	ON or OFF

LED States

State	Description
Error	ON or OFF. This is the ERR LED above the power connector.
Config	ON or OFF. This is the CFG LED above the power connector.
Fault	ON or OFF. This is the FLT LED above the power connector.
MS	OFF. This is not used by the PLX82-MNET-61850.
NS	OFF. This is not used by the PLX82-MNET-61850.

Network Configuration

Function	Description
IP Address	This is the gateway's configured IP address you entered in ProSoft MNET-61850 Configuration Manager.
Network Mask	This is the gateway's configured network mask you entered.
Gateway	This is the gateway's configured gateway you entered.

Operation Mode

Values may be:

Init, Start, Ready, Run, Stop, Restart, Shutdown, Done

Product Information

Field	Description
Product Type	Gateway
Product Name	PLX82-MNET-61850
Module Name	This is the name that you entered in the <i>Gateway Configuration</i> window.
Product Version	This is the version of the PLX82-MNET-61850.
MAC Address	This is the MAC address of the gateway.
Serial Number	This is the Serial Number of the gateway.

System Information

Version: This is the version of the PLX82-MNET-61850 product.

System Status

This shows the setting of the **FLT** LED. Values shown here may be **OK** and **FLT** (fault).

System Uptime

The total system uptime is number of days plus number of hours plus number of minutes plus number of seconds.

Value	Description
Days	Number of days the gateway has been operating since the last power-up.
Hours	Number of hours the gateway has been operating since the last power-up.
Minutes	Number of minutes the gateway has been operating since the last power-up.
Seconds	Number of seconds the gateway has been operating since the last power-up.

7.7.3 Modbus TCP/IP Diagnostics

The following Modbus TCP/IP Client diagnostics data is available from the gateway:

Modbus TCP/IP Client (MNETC)

The following Modbus TCP/IP Client diagnostic data is available from the gateway:

- Client Configuration
- Client Status
- Command List
- Command Status
- Configuration Settings
- Reset Status Counters

Client Configuration

Value	Description
Client	Client index number
Minimum Command Delay	This value is set by the user in the configuration window. This is the minimum number of microseconds between commands. This can be a value in the range 0 to 32767 , with a default value of 0. This parameter can be used to delay all commands sent to the Modbus TCP/IP Server (PLC) to avoid "flooding" commands on the network. This parameter does not affect retries of a command as they will be issued when failure is recognized.
Response Timeout	This value is set by the user in the configuration window. This is the time in milliseconds that the Modbus TCP/IP Client will wait before re-transmitting a command if no response is received from the addressed Server. This can be a value in the range 0 to 65535 , with a default value of 1000. The value to use depends upon the type of communication network used, and the expected response time of the slowest device on the network.
Retry Count	This value is set by the user in the configuration window. This parameter specifies the number of times a command will be retried if it fails. This can be a value in the range 0 to 10 , with a default value of 1000.
Command Error Delay	This value is set by the user in the configuration window. This parameter specifies the number of 100 millisecond intervals to turn off a command in the error list after an error is recognized for the command. If this parameter is set to 0, there will be no delay. This can be a value in the range 0 to 300 , with a default value of 300.

Client Status

The following client diagnostics data is available from the gateway:

Function	Description
Client	This is a number (0 to 19) referring to the Modbus device to which the module is communicating. The name comes from the configuration file.
Client Name	Optional
Command Requests	The total number of commands executed by the MNET driver since its last startup.
Command Responses	The total count of responses received to commands sent.
Command Responses Parsed	The total count of responses received to commands sent.
Exception Responses Received	The total number of exception responses received.
Bad Packets Received	The total number of bad packets received. The client polled for some information from the server, and the response was unknown to the driver. Usually, nothing is shown here.

Command List

Value	Description
Client	Client index number
Client Name	This data is shown for each command, in a scrolling list: Command <command number>:
Enable	0 = The command is disabled and is not executed in the normal polling sequence. 1 = The command is executed each scan of the command list if the POLL INTERVAL TIME is set to zero. If the Poll Interval Time is not zero, the command is executed when the interval timer expires. 2 = The command executes only if the internal data associated with the command changes.
Poll Interval	This specifies the minimum interval to execute continuous commands (ENABLE set to 1). The parameter is entered in 1/10th of a second. Therefore, if a value of 100 is entered for a command, the command executes no more frequently than every 10 seconds.
Function	This specifies the Modbus function to be executed by the command. These function codes are defined in the Modbus protocol. 3 = Read Holding Registers(4X) 6 = Preset (Write) Single Register(4X)
Start Register	The starting register within the target device to start reading/writing.
Register Count	Registers 1 to 125 This specifies the number of registers or digital points to be associated with the command. In the case of floats the count will be 1 for each float.

Swap Code	<p>0 = None - No Change is made in the byte ordering 1 = Words - The words are swapped 2 = Words & Bytes - The words are swapped then the bytes in each word are swapped 3 = Bytes - The bytes in each word are swapped. The words should be swapped only when using an even number of words.</p>
Node IP	The IP address of the device being addressed by the command.
Service Port	This is 502 or 2000 . A value of 502 is used to address Modbus TCP/IP servers which are compatible with the Schneider Electric MBAP specifications (most devices)
Slave Address	This parameter is always 1 for Modbus TCP/IP.
FC 23 Read Address	FC 23 Read Address: This is always 0 . This function code is not supported for PLX82-MNET-61850.
FC 23 Write Address	FC 23 Write Address: This is always 0 . This function code is not supported for PLX82-MNET-61850.

Command Status

Value	Description
Current Error	The current error code
Last Error	The last error code detected
Execution Count	The total number of executed commands

Configuration Settings

This displays the version number of the MNET driver in the ProSoft gateway.

Reset Status Counters

The purpose of this item is to cause a reset action in the MNET driver. When you click this, you will see a **RESPONSE** field with the default value of **OK**. Use this to reset the counters shown on the *Client Status* and *Command Status* diagnostic windows.

Modbus TCP/IP Server (MNETS)

The following Modbus TCP/IP Server diagnostic data is available from the gateway:

- Configuration Settings
- Reset Status Counters
- Server Configuration
- Server Status

Configuration Settings

This displays the version number of the MNET driver in the ProSoft gateway.

Reset Status Counters

The purpose of this item is to cause a reset action in the MNET driver. When you click this, you will see a **RESPONSE** field with the default value of **OK**. Use this to reset the counters shown on the *Server Status* diagnostic window.

Server Configuration

Value	Description
Connection Timeout	This is the connection timeout, as set on the ProSoft Gateway Configuration window by the user. This is in seconds. The default value is 60 .
MBAP Ports	This is the No of MBAP Server value as set on the ProSoft Gateway Configuration window by the user. The default value is 20 . Most Modbus devices use MBAP.
MNET Ports	This is the No of MBAP Server value as set on the ProSoft Gateway Configuration window by the user. The default value is 20. Most Modbus devices use MBAP.

Server Status

Value	Description
MBAP Server	The number of connections to the gateway MBAP Server
Requests	The total count of requests received for data
Responses	The total count of responses sent
Errors Received	The total number of errors received
Errors Sent	The total number of errors sent
Current Error	The current error code
Last Error	The last error code detected
State	1 = Communicating, 0 = Not communicating

Modbus Error Codes

Exception Code	Status	Description
01	Illegal Function Code	The function code is unknown by the server.
02	Illegal Data Address	Dependent upon the request
03	Illegal Data Value	Dependent on the request
04	Server Failure	The server failed during the execution.
05	Acknowledge	The server accepted the service invocation but the service requires a relatively long time to execute. The server therefore returns only an acknowledgment of the service invocation receipt.
06	Server Busy	The server was unable to accept the MB Request PDU. The client application is responsible to decide if and when to re-send the request.

The following Current Error diagnostics data is available from the gateway:

- Standard Modbus Protocol Errors
- Module Communication Error Codes
- MNET Client Specific Errors
- Command List Entry Errors

Standard Modbus Protocol Errors

Code	Description
1	Illegal function
2	Illegal Data Address
3	Illegal Data Value
4	Failure in Associated Device
5	Acknowledge
6	Busy, Rejected Message

Modbus Communication Error Codes

Code	Description
-1	CTS modem control line not set before transmit
-2	Timeout while transmitting message
-11	Timeout waiting for response after request
253	Incorrect slave address in response
254	Incorrect function code in response
255	Invalid CRC/LRC value in response

MNET Client Specific Errors

Code	Description
-33	Failed to connect to server specified in command
-36	MNET command response timeout
-37	TCP/IP connection ended before session finished

Command List Entry Errors

Code	Description
-40	Too few parameters
-41	Invalid enable code
-42	Internal address > maximum address
-43	Invalid node address (< 0 or > 255)
-44	Count parameter set to 0
-45	Invalid function code
-46	Invalid swap code
-47	ARP could not resolve MAC from IP (bad IP address, not part of a network, invalid parameter to ARP routine).
-48	Error during ARP operation: the response to the ARP request did not arrive to the gateway after a user-adjustable ARP Timeout.

7.7.4 SNTP/NTP

Configuration Settings

The following Configuration Settings diagnostic data is available from the gateway.

Value	Description
Version	Firmware version
Configured Communications Port	ETH 1 or ETH 2
Update rate in Minutes	How frequently the time is synchronized via SNTP/NTP. This is a configured value that is set on the Gateway Configuration window, in the SNTP/NTP Update Time field.
Server Address	The IP address or domain name for the SNTP/NTP server. This is a configured value that is set on the Gateway Configuration window, in the SNTP/NTP Address field.

Driver Status

The following Driver Status diagnostic data is available from the gateway.

Value	Description
Status	This is the result of the latest poll. Values are OK or Error retrieving time from SNTP/NTP server.
Poll Count	This is the number of update attempts (at the configured frequency) since startup (unsigned long rolls over at 4 billion plus). If Poll Count is zero (before first attempt, or configured update time is 0 for never poll) Status is OK.

Clock Update Count	This displays the number of times the gateway's clock has been updated.
Error Count	This is the number of unsuccessful times the gateway has attempted to reach the SNTP/ NTP Server.

7.8 Web Service and Gateway Web Page

When the gateway's IP address is accessed through a browser (such as Internet Explorer) or the ProSoft Discovery Service, it shows the gateway's web page. The gateway's Web Services are connection-based, and therefore can accept multiple connections at a time. Multiple users can view the gateway's web page at the same time.

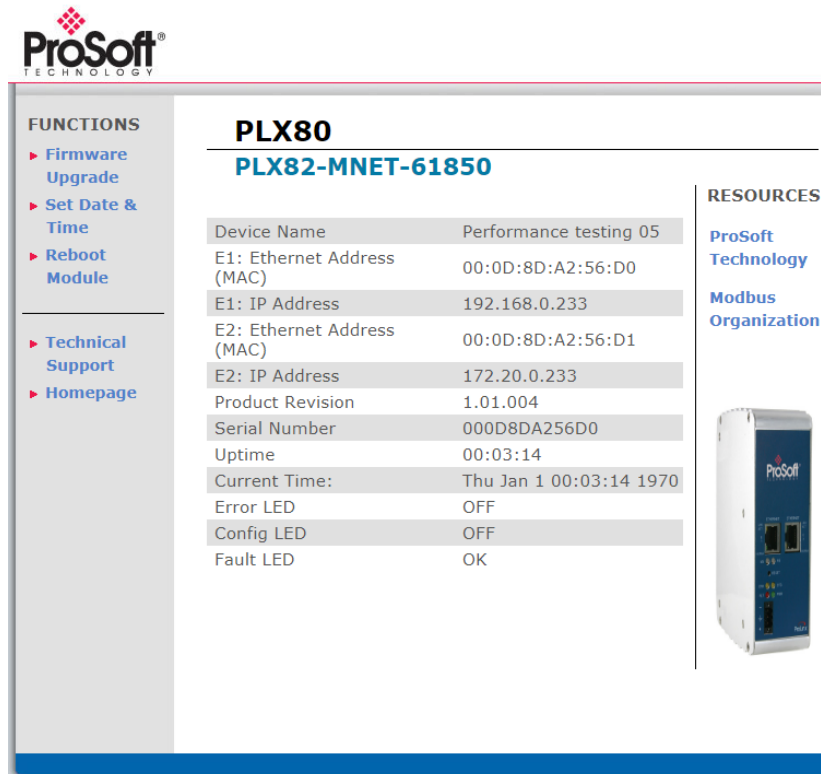

Functions

Parameter	Description
Firmware Upgrade	Click to upgrade the firmware in the gateway. Only do this if instructed to do so by ProSoft Technology Technical Support.
Set Date & Time	Click to set the date and time in the gateway.
Reboot Module	Click reboot the gateway.
Technical Support	Click to be directed to the ProSoft Technology Technical Support website.
Homepage	Click to go to the gateway's homepage (shown above).

Resources

Parameter	Description
ProSoft Technology	Click to be directed to ProSoft Technology's Web site.
Modbus Organization	Click to be directed to the Modbus website.

The following information is shown on the Home Page of the gateway web page:

Parameter	Description
Device Name	The Project Name you set in the ProSoft MNET-61850 Configuration Manager.
Ethernet Address (MAC)	The gateway's MAC address.
IP Address	The gateway's IP Address.
Product Revision	The product revision number, determined by the version number of the firmware currently in the gateway.
Serial Number	The gateway's serial number.
Uptime	The number of hours, minutes, and seconds that the gateway has been "up" or "alive" since the last reboot or reconnection of power.
Current Time	The gateway's current time. You can change the gateway's time by using SNTP as described in Ethernet Port Configurations (page 17), or by choosing Functions / Set Date & Time on the gateway's webpage.
Error LED	ON or OFF. This is the ERR LED above the power connector.
Config LED	ON or OFF. This is the CFG LED above the power connector.
Fault LED	OK or ON. This is the FLT LED above the power connector.

7.9 Event Logger

The gateway’s internal processes and drivers write event log data to the Event Logger. You can access the Event Logger from ProSoft MNET-61850 Configuration Manager by right-clicking the **PROSOFT GATEWAY** bubble, and choosing **EVENT LOGGER**.

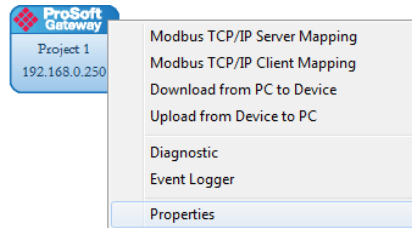

The data written to the *Event Logger* is:

- Event Level
- Date & Time
- Resource
- Driver
- Error Message

Here are the possible Event Levels and their descriptions:

Event	Description
DEBUG	Very detailed debug data to the event log that needed to help ProSoft Technical Support
INFO	Potential problem, but not an error
WARNING	Potential problem, but not an error
ERROR	System errors
FATAL	Fatal system problem that is causing a process to terminate

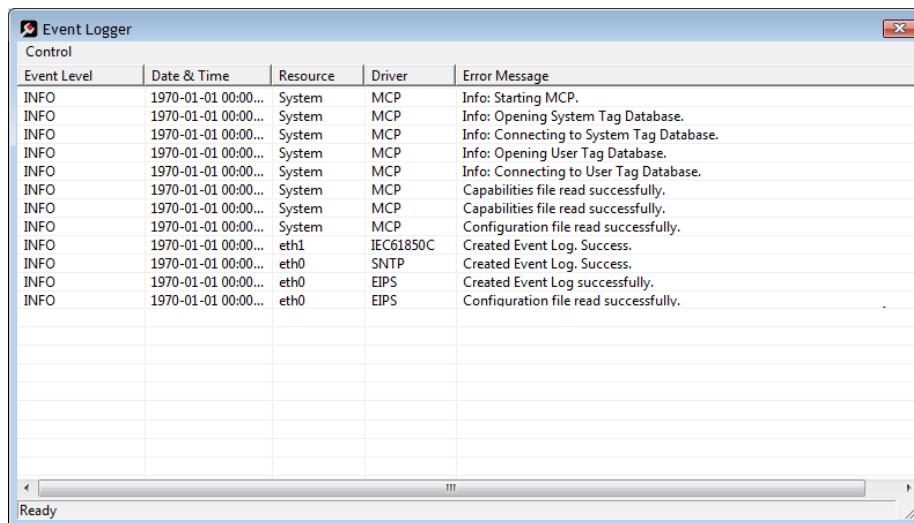

7.9.1 61850C Events

The following are examples that may appear in the Event Log.

```
"61850C_CREATE_EVENTLOG_INFO", "Created Event Log."};  
"61850C_CREATE_EVENTLOG_FATAL", "Failed Create Event Log."};  
"61850C_LOADING_DATABASE_FATAL", "Error Loading Database."};  
"61850C_LOADING_SYSDATABASE_FATAL", "Error Loading System Database."};  
"61850C_GET_VAR_TYPE_ID_FATAL", "Error getting initial var type id."};  
"IEC61850C_ERROR_CONNECTING_MCPINTERFACE_FATAL", "Cannot Connect to MCP Interface."};  
"IEC61850C_CONTROL_NOT_SUPPORTED_INFO", "Control Method Not Supported."};  
"IEC61850C_CNXXN_DIDNT_START_INFO", "End Node Connection did not start."};  
"IEC61850C_NEED_ONE_VAR_MAPPED_INFO", "Need at least one 61850 Var mapped."};  
"IEC61850C_ERROR_STARTING_MVL_ACSE_FATAL", "Error Starting MVL_ACSE Subsystem."};  
"IEC61850C_ERROR_FINDING_REPORT_TYPEIDS_FATAL", "Error Finding Report Type ID's."};  
"61850C_CMD_TAG_PTR_IS_NULL_FATAL", "Error getting Tag Pointer for command."};  
"61850C_RPT_TAG_PTR_IS_NULL_FATAL", "Error getting Tag Pointer for report."};  
"61850C_GSE_TAG_PTR_IS_NULL_FATAL", "Error getting Tag Pointer for goose subscription."};  
"IEC61850C_RPT_INTEGRITY_PERIOD_SET_DEFAULT_INFO", "Report Integrity Period Set to Default."};  
"IEC61850C_ISCAN_DELAY_SET_DEFAULT_INFO", "Interscan Delay Period (2ms) Set to Default."};  
"IEC61850C_RPT_CONFREV_TYPE_NOT_VALID_INFO", "Report Config Rev Type not Valid."};  
"IEC61850C_RPT_CONFREV_READ_ERROR_INFO", "Report Config Rev Read Error."};  
"IEC61850C_RPT_CONFREV_DOESNT_MATCH_CFG_INFO", "Rpt confRev doesn't match, Rpt Not  
Started."};  
"IEC61850C_RPT_CONFREV_RECONNECT_NO_MATCH_CFG_INFO", "Rpt confRev doesn't match, Rpt  
Not Reconnected."};  
"IEC61850C_GSE_DATA_TYPE_ERROR_INFO", "GOOSE Data Type NULL Error."};  
"IEC61850C_GCB_CONFREV_TYPE_NOT_VALID_INFO", "GCB Config Rev Type not Valid."};  
"IEC61850C_GCB_CONFREV_READ_ERROR_INFO", "GCB Config Rev Read Error."};  
"IEC61850C_GCB_CONFREV_DOESNT_MATCH_CFG_INFO", "GCB confRev doesn't match, Subscribe  
Not Started."};
```

7.9.2 MNET Events 1

The following are examples that may appear in the Event Log.

```
"MNET_CREATE_CLIENT_FATAL", "Cannot Create Client";
"MNET_CREATE_THREAD_FATAL", "Cannot Create Thread.";
"MNET_LOADING_DATABASE_FATAL", "Error Loading Database";
"MNET_ERROR_CREATING_SOCKET_FATAL", "Error creating network socket";
"MNET_ERROR_SETTING_SOCKET_OPTION_FATAL", "Error setting socket option.";
"MNET_ERROR_BINDING_SOCKET", "Error binding network socket. Port number = {0}.";
"MNET_ERROR_CONNECTING_TO_SOCKET_ERROR", "Error connecting to network socket at {0} port
{1}.";
"MNET_CONNECTION_SUCCESSFUL_INFO", "Successfully connected to {0}.";
"MNET_CLIENT_CONFIGURATION_FILE_PARSED_INFO", "Configuration file parsed.";
"MNET_CONFIG_BAD_FORMAT_RESOURCE_FATAL", "Bad Configuration file format. Missing Resource:
{0}.";
"MNET_CONFIG_BAD_FORMAT_RESOURCE_FATAL", "Bad Configuration file format. Missing Driver:
{0}.";
"MNET_CONFIG_EXCEED_MAX_CLIENTS_ERROR", "Client number {0} exceeds maximum Clients.";
"MNET_CONFIG_GET_TAG_ERROR", "Get Tag error: Error code {0}, Error position {1}.";
"MNET_CONFIG_MAP_RANGE_ERROR", "Tag Map Out Of Range.";
"MNET_CONFIG_COPY_TABLE_PTR_ERROR", "Copy Table Pointer is NULL.";
"MNET_CONFIG_DATAMAP_PTR_ERROR", "Datamap Pointer is NULL.";
"MNET_CONFIG_COMMAND_LIST_PTR_ERROR", "Command List Pointer is NULL.";
"MNET_CONFIG_CLIENT_LIST_PTR_ERROR", "Client List Pointer is NULL.";
"MNET_CONFIG_TAG_PTR_ERROR", "Tag Pointer is NULL.";
"MNET_BUILD_COMMAND_ERROR", "Error Building Command {0}.";
"MNET_SEND_ERROR", "Error Sending Message to Server.";
"MNET_SELECT_FAIL_ERROR", "Select Function Failed.";
"MNET_RESPONSE_TIMEOUT_ERROR", "Response Timeout.";
"MNET_RESPONSE_PARSE_ERROR", "Response Parsing Error {0}.";
"MNET_TAG_COPY_COUNT_ZERO_ERROR", "Tag Copy Count Is Zero.";
"MNET_ERROR_CONNECTING_MCPINTERFACE_FATAL", "Cannot Connect to MCP Interface";
"MNET_SOCKET_CONNECTION_LOST_ERROR", "Socket Connection Lost.";
"MNET_CREATE_OBJ_FATAL", "Cannot Create class object.";
```

7.9.3 MNET Events 2

The following are examples that may appear in the Event Log.

```
"MNET_CREATE_SERVER_FATAL", "Cannot Create Server";  
"MNET_CREATE_THREAD_FATAL", "Cannot Create Thread."};  
"MNET_LOADING_DATABASE_FATAL", "Error Loading Database";  
"MNET_ERROR_CREATING_SOCKET_FATAL", "Error creating network socket";  
"MNET_ERROR_SETTING_SOCKET_OPTION_FATAL", "Error setting socket option."};  
"MNET_ERROR_BINDING_SOCKET", "Error binding network socket. Port number = {0}."};  
"MNET_SERVER_CONFIGURATION_FILE_PARSED_INFO", "Configuration file parsed."};  
"MNET_CONFIG_BAD_FORMAT_RESOURCE_FATAL", "Bad Configuration file format. Missing Resource:  
{0}."};  
"MNET_CONFIG_BAD_FORMAT_RESOURCE_FATAL", "Bad Configuration file format. Missing Driver:  
{0}."};  
"MNET_CONFIG_EXCEED_MAX_SERVERS_ERROR", "Server number {0} exceeds maximum servers."};  
"MNET_CONFIG_GET_TAG_ERROR", "Get Tag error: Error code {0}, Error position {1}."};  
"MNET_CONFIG_MAP_RANGE_ERROR", "Tag Map Out Of Range."};  
"MNET_CONFIG_COPY_TABLE_PTR_ERROR", "Copy Table Pointer is NULL."};  
"MNET_CONFIG_DATAMAP_PTR_ERROR", "Datamap Pointer is NULL."};  
"MNET_CONFIG_SERVER_LIST_PTR_ERROR", "Server List Pointer is NULL."};  
"MNET_CONFIG_TAG_PTR_ERROR", "Tag Pointer is NULL."};  
"MNET_SEND_ERROR", "Error Sending Message to Client."};  
"MNET_SELECT_FAIL_ERROR", "Select Function Failed."};  
"MNET_TAG_COPY_COUNT_ZERO_ERROR", "Tag Copy Count Is Zero."};  
"MNET_ERROR_GETTING_SOCKET_NAME_FATAL", "Error getting socket name."};  
"MNET_ERROR_SETTING_PORT_FATAL", "Error setting socket port."};  
"MNET_LISTEN_ERROR_FATAL", "Socket listen failed."};  
"MNET_CONFIG_CREATE_OBJ_ERROR", "Error creating object."};  
"MNET_ACCEPT_ERROR_FATAL", "Socket accept failed."};  
"MNET_ALLOC_MEMORY_FATAL", "Unable to allocate memory."};  
"MNET_CREATING_CONFIGURATION_FATAL", "Error Creating Configuration";  
"MNET_SERVER_TIMEOUT_ERROR", "Server connection timed out."};  
"MNET_CREATE_OBJ_FATAL", "Cannot Create class object."};  
"MNET_RECV_FAIL_ERROR", "Recv Function Failed."};  
"MNET_ERROR_CONNECTING_MCPINTERFACE_FATAL", "Cannot Connect to MCP Interface";  
"MNET_SOCKET_CONNECTION_LOST_ERROR", "Socket Connection Lost."};
```

7.9.4 MCP Events

The following are examples that may appear in the Event Log.

```
"MCP_START_INFO", "Info: Starting MCP.";  
"MCP_CAPABILITIES_FILE_PARSED_INFO", "Capabilities file read successfully.";  
"MCP_CONFIGURATION_FILE_PARSED_INFO", "Configuration file read successfully.";  
"MCP_DRIVER_STOPPED_UNEXPECTEDLY_ERROR", "Driver stopped unexpectedly, Resource: {1}  
Driver: {2}.";  
"MCP_CAPABILITIES_FILE_NOT_FOUND_FATAL", "Capabilities file not found.";  
"MCP_CAPABILITIES_FILE_EMPTY_FATAL", "Capabilities file empty.";  
"MCP_CAPABILITIES_BAD_FORMAT_FATAL", "Bad Capabilities file format. Missing: {1}.";  
"MCP_CONFIG_FILE_NOT_FOUND_FATAL", "Configuration file not found.";  
"MCP_CONFIG_FILE_EMPTY_FATAL", "Configuration file empty.";  
"MCP_CONFIG_BAD_FORMAT_FATAL", "Bad Configuration file format. Missing: {1}.";  
"MCP_TERMINATING_FATAL", "Fatal error found! Terminating MCP in {1} seconds.";  
"MCP_START_DEBUG", "Debug: Starting MCP.";  
"MCP_START_WARNING", "Warning: Starting MCP.";  
"MCP_START_ERROR", "Error: Starting MCP.";  
"MCP_START_FATAL", "Fatal: Starting MCP.";  
"MCP_CREATE_THREAD_FATAL", "Error creating thread. Return code from pthread_create() = {1}.";  
"MCP_FILE_ERROR", "Error opening file.";  
"MCP_TAGDB_FAIL_FATAL", "Failure opening Tag Database.";  
"MCP_SYSDB_FAIL_FATAL", "Failure opening System Database.";  
"MCP_OPEN_TAGDB_INFO", "Info: Opening Tag Database.";  
"MCP_OPEN_SYSDB_INFO", "Info: Opening System Tag Database.";  
"MCP_CONNECT_SYSDB_INFO", "Info: Connecting to System Tag Database.";  
"MCP_LOADING_DATABASE_FATAL", "Failure connecting to Tag Database.";  
"MCP_UNSCHEDULED_TERMINATION_INFO", "Driver termination.";  
"MCP_DRIVER_KILL_INFO", "Info: Issuing kill signal to driver.";  
"MCP_SYSTEM_TAG_INIT_FAILURE_FATAL", "Failure initializing system tags.";  
"MCP_SYSTEM_OPERATIONS_STOPPED_FATAL", "MCP Stopped operations.";
```

7.9.5 MCP Interface Events

The following are examples that may appear in the Event Log.

```
"MCP_INTERFACE_INIT_FAILED_FATAL", "Initialization failed.";  
"MCP_INTERFACE_LOADING_DATABASE_FATAL", "Error Loading Database.";  
"MCP_INTERFACE_GET_TAG_ERROR", "Get Tag error: Error code {0}, Error position {1}.";
```

7.9.6 Sntp/NTP Events

The following are examples that may appear in the Event Log.

```
"SNTP_CREATE_EVENTLOG_INFO", "Created Event Log.";  
"SNTP_CREATE_EVENTLOG_FATAL", "Failed Create Event Log.";  
"SNTP_LOADING_DATABASE_FATAL", "Error Loading Database.";  
"SNTP_ERROR_CONNECTING_MCPINTERFACE_FATAL", "Cannot Connect to MCP Interface.";  
"SNTP_UPDATE_TIME_FROM_SNTPSERVER_INFO", "Updated Time from Sntp Server.";
```

7.9.7 InterProcess Communication (IPC) Events

The following are examples that may appear in the Event Log.

```
"IPC_ACCEPTED_SOCKET", "Accepted new connection from Client %s on socket %d."};
"IPC_BAD_MESSAGE_HEADER", "Start of IPC message header was not equal to {0}. Socket will be
closed."};
"IPC_CONNECTION_SUCCESSFUL", "Successfully connected to {0}."};
"IPC_ERROR_BINDING_SOCKET", "Error binding network socket. Port number = {0}."};
"IPC_ERROR_CLOSING_SOCKET", "Error closing network socket."};
"IPC_ERROR_CONNECTING_TO_SOCKET", "Error connecting to network socket at {0} port {1}."};
"IPC_ERROR_CREATING_SOCKET", "Error creating network socket."};
"IPC_ERROR_GETTING_SOCKET_NAME", "Error getting socket name."};
"IPC_ERROR_READING_MESSAGE_FORMAT", "Error reading message format from IPC message
header. Expected to read {0} bytes, but only read {1} bytes."};
"IPC_ERROR_READING_MESSAGE_LENGTH", "Error reading message length from IPC message
header. Expected to read {0} bytes, but only read {1} bytes."};
"IPC_ERROR_SENDING_DATA", "Error sending data to remote system."};
"IPC_ERROR_SENDING_MESSAGE", "Error sending message to remote system."};
"IPC_ERROR_SETTING_SOCKET_OPTION", "Error setting socket option."};
"IPC_INVALID_MESSAGE_FORMAT", "Invalid message format found in IPC message header. Invalid
message format value = {0}."};
"IPC_LISTEN_ERROR", "Error listening on network socket."};
"IPC_MESSAGE_LENGTH_MISMATCH", "Error reading IPC message. Message length did not match
number of bytes read. Message length = {0}. Number bytes read = {1}."};
"IPC_RECEIVE_BUFFER_TOO_SMALL", "Unable to receive IPC message because message length is
larger than receive buffer. IPC message length = {0}. Receive buffer size = {1}."};
"IPC_REMOTE_CLIENT_DISCONNECTED", "Closing socket because remote Client disconnected."};
"IPC_SOCKET_ACCEPT_ERROR", "Error accepting new network socket connection."};
"IPC_SOCKET_ERROR", "Socket error occurred. Closing socket."};
"IPC_SOCKET_SELECT_ERROR", "Error returned from socket select().";
```

8 Reference

8.1 Specifications

8.1.1 *PLX82-MNET-61850 Overview*

The PLX82-MNET-61850 gateway is enclosed in a sturdy extruded aluminum case with DIN-rail-mounting.

Specification	Description
Hardware	Two (2) Ethernet port for Modbus TCP/IP and IEC 61850 communication
Software	<ul style="list-style-type: none">▪ ProSoft MNET-61850 Configuration Manager for configuration and diagnostic viewing▪ ProSoft EIP-61850 Tag Monitor for viewing live tag data▪ ProSoft Discovery Service for setting a temporary IP address
Configuration Storage	<ul style="list-style-type: none">▪ Internally stored, by default. Configuration settings can be saved on an optional removable 1GB Industrial SD Card.▪ ProSoft MNET-61850 Configuration Manager saves configuration information to an offline file

8.1.2 Specifications - Modbus TCP/IP

The Modbus TCP/IP driver allows multiple independent, concurrent Ethernet connections. The connections may be all clients, all servers, or a combination of both client and server connections.

Modbus TCP/IP client

- Actively reads data from and writes data to Modbus TCP/IP devices using MBAP
- Up to 10 client connections with multiple commands to talk to multiple servers

Modbus TCP/IP server

- The server driver accepts incoming connections on Service Port 502 for clients using Modbus TCP/IP MBAP messages and connections on Service Port 2000 (or other Service Ports) for clients using Encapsulated Modbus messages.
- Supports multiple independent server connections for any combination of Service Port 502 (MBAP) and Service Port 2000 (Encapsulated)
- Up to 20 Servers are supported

Specification	Description
Modbus Commands Supported (Client and Server)	3: Read Holding Registers 16: Preset (Write) Multiple Holding Registers
Configurable Parameters: (Client and Server)	Gateway IP Address PLC Read Start Register (%MW) PLC Write Start Register (%MW) Number of MBAP and MNET servers Gateway Modbus Read Start Address Gateway Modbus Write Start Address
Configurable Parameters: Client Only	Minimum Command Delay Response Timeout Retry Count Command Error Pointer
Command List	Up to 2000 Modbus commands (one tag per command)
Status Data	Error codes reported individually for each command. High-level status data available from Modbus TCP/IP client (for example PLC or PAC).
Command List Polling	Each command can be individually enabled or disabled; write-only-on-data-change is available.

8.1.3 Specifications - IEC 61850 Client

- Supports up to 45 IEDs
- Send commands from the PAC to the IED using Control Types
- Direct-with-Normal-Security
- Select Before Operate (SBO)-with-Normal-Security
- Direct-with-Normal-Security
- Select Before Operate (SBO)-with-Normal-Security

Specification	Description
ASCI Basic Conformance	
SCSMs supported	SCSM: IEC 61850 8.1(MMS) used
Generic substation event model (GSE)	Subscriber
ASCI Model Conformance	
Reporting	<ul style="list-style-type: none"> ▪ Buffered Report Control Block (BRCB) ▪ Unbuffered Report Control Block (URCB)
GOOSE	<ul style="list-style-type: none"> ▪ entryID, DataRefInc
Control	<ul style="list-style-type: none"> ▪ Direct-with-Normal-Security ▪ SBO-with-Normal-Security ▪ Direct-with-Enhanced-Security ▪ SBO-with-Enhanced-Security
Logical Nodes	<ul style="list-style-type: none"> ▪ IEC 61850 Logical Nodes, including Logical Nodes for Hydro Power Plants and Logical Nodes for Wind Power Plants
Configurable Parameters	<ul style="list-style-type: none"> ▪ MMS Command Delay
Status Data	<ul style="list-style-type: none"> ▪ Status available per node ▪ Report and GOOSE status available ▪ High-level status data available from Modbus TCP/IP client through the MNET server (for example PLC or PAC)

8.1.4 Specifications - SNTP/NTP Client

The gateway supports a Simple Network Time Protocol (SNTP/NTP) client service that can synchronize the gateway's time by periodic update requests to a Coordinated Universal Time (UTC) system. You can configure the SNTP/NTP server details in ProSoft MNET-61850 Configuration Manager. The resolution of the time is in milliseconds (ms).

Specification	Description
Configurable Parameters	<ul style="list-style-type: none"> ▪ SNTP/NTP server synchronization rate (in minutes) ▪ SNTP/NTP server Address

8.2 Hardware Specifications

Specification	Description
Power Supply	24 VDC nominal 10 to 32 VDC power input allowed Positive, Negative, GND Terminals
Current Load	200 mA maximum @ 24 VDC 150 mA maximum @ 32 VDC 450 mA maximum @ 10 VDC
Operating Temperature	0°C to 70°C (32°F to 158°F)
Storage Temperature	-40°F to 185°F (-40°C to 85°C)
Relative Humidity	5% to 95% RH, with no condensation
Dimensions H x W x D	5.52 x 2.06 x 4.37 in 14.02 x 5.23 x 11.1 cm
Ethernet Ports ETH 1, ETH 2	10/100 Base-T full- and half-duplex RJ45 Connector Link and Activity LED indicators Electrical Isolation 1500 V rms at 50 Hz to 60 Hz for 60 s, applied as specified in section 5.3.2 of IEC 60950: 1991 Ethernet Broadcast Storm Resiliency = less than or equal to 5000 [ARP] frames-per-second and less than or equal to 5 minutes duration
LED Indicators	ERR, CFG, FLT, PWR
Shock and Vibration	Shock and Vibration tested to EN 60068 Standard
Shipped with Each Unit	One - J180 3-wire DC power connector One - HRD250 screwdriver

8.3 PLX82-MNET-61850 Gateway

8.3.1 *Asynchronous Processes*

The ProSoft gateway has a number of processes and drivers running in a multitasking firmware environment. An IEC 61850 Client driver, a Modbus TCP/IP Client driver, and a Modbus TCP/IP Server driver operate asynchronously within this multitasking environment, along with other firmware processes. The drivers are independently processing the commands and messages in their queues as quickly as possible, giving priority to GOOSE messages.

The Modbus TCP/IP Client driver processes commands that have been enabled for continuous execution in the command list, starting with the first command and going through them sequentially until it gets to the last one. After the last command in the list has been completed, the driver starts over again at the first command and continues to cycle through the list, over and over again, as quickly as possible. The larger the Client Command List, the longer it takes the driver to cycle through the list.

Meanwhile, the IEC 61850 client may be receiving large amounts of data from the configured IEDs. If so, the IEC 61850 client updates the Tag Database with data coming from the IEDs asynchronously from the MNET Client driver.

Since the different drivers run asynchronously from each other and depending upon how fast or how often the IEDs send data, it is possible that a tag in the tag database may be updated more than once by the IEC 61850 Client driver before the Modbus TCP/IP Client driver sees the update and can send the data to a Modbus server.

IED data changes are not buffered, so, the Modbus TCP/IP Client driver may not be able to transfer every data change that happens in the IEC 61850 Client tag database. Only the data most recently stored in the tag database by the IEC 61850 Client driver is available for the MNET Client driver to transfer to the Modbus devices. So, it is possible that some changes in data values on some IEDs may be lost in the process, especially during times of high volume of data traffic from the IEDs.

8.3.2 Tag Database

The Tag database is a key part of the internal workings of the gateway. Upon restart, the Tag database reads the configuration file, and process the tags. Data is stored in the gateway’s memory, and referenced through tag names. The number of tags is limited to the memory capability of the hardware and the process memory required by gateway. The data of varying data types are stored in the gateway. This impacts that maximum number of tags the gateway can hold.

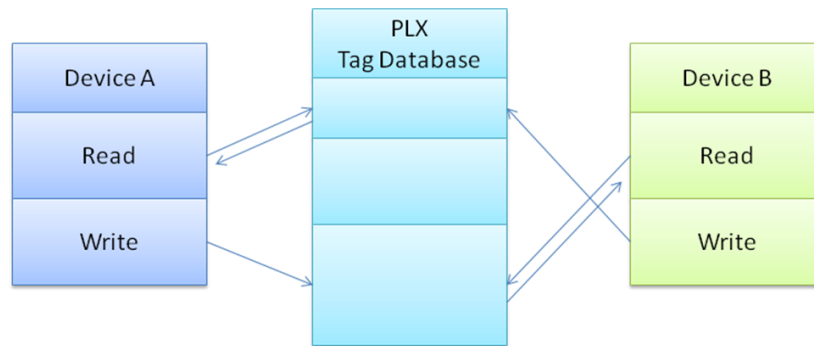

Some data types are considered **Native** data types to the gateway, and some are considered **Complex**. Complex data types are for the creation of the user-defined data types, which are necessary for many IEC 61850 data types.

Native data types

Native data types are the data types used internal to the gateway. When the data is transferred from IEC 61850 to Modbus TCP/IP, it is first stored in the Tag database, using the following data types:

Name	Definition	Bits
BOOL	Boolean	1
BYTE	Byte	8
UBYTE	Unsigned Byte	8
INT	Integer	16
UINT	Unsigned Integer	16
DINT	Double Integer	32
UDINT	Unsigned Double Integer	32
REAL	IEEE 754 Single Precision Floating-Point	32
DREAL	IEEE 754 Double Precision Floating-Point	64
STRING	ASCII Character Array	32 + 8* Length
DATETIME	UTC microsecond precision date and time	64

8.3.3 SNTP/NTP

This section covers the gateway's implementation of IEC 61850-7-2 Clause 18: Time and time-synchronization model (SNTP/NTP).

The IEC 61850 driver in the gateway is dependent upon the gateway's SNTP/NTP server. The gateway can set its time by making periodic requests for the current time to a Coordinated Universal Time (UTC) system. You can define a NTP server in ProSoft MNET-61850 Configuration Manager. It must be synchronized to some known level of accuracy, and the elapsed seconds received by the NTP server are since a defined Epoch, and the time server shall indicate LeapSecondsKnown (true or false).

There are two configuration parameters:

- SNTP/NTP server Address
- SNTP/NTP server Update Time (in minutes)

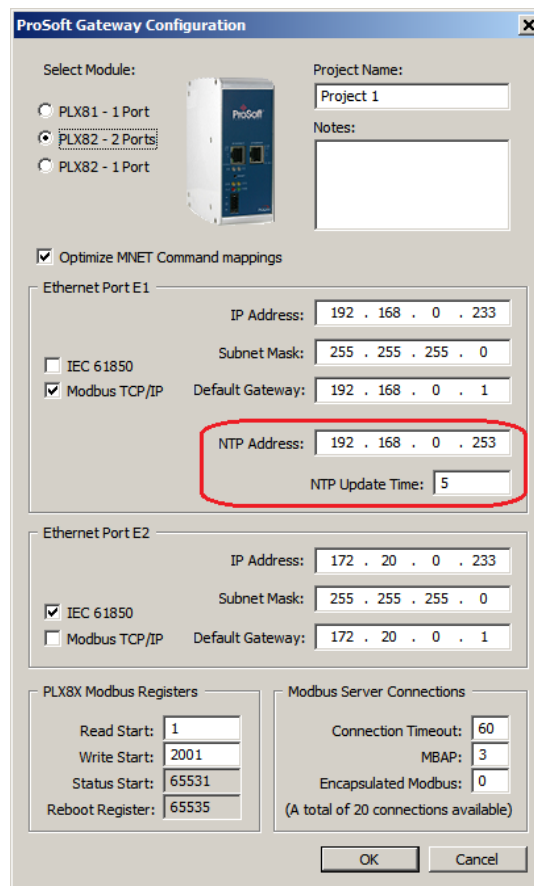

The gateway hardware is 17 seconds off per day for a Linux clock. If better time synchronization is required, you must perform the setup for the SNTP/NTP time server either from the internet or local clock that can sync up every one (1) minute as configured on the gateway.

8.4 IEC 61850 Detailed Specifications

The IEC 61850 client driver supports the MMS (ISO 9506-1 and ISO 9506-2) communication profile.

Part 7-2 of the IEC 61850 protocol specification lists the basic communication structure and abstract communication service interface (ACSI). This IEC 61850 client driver supports the following 7-2 models:

- Association
- Data Set
- Report Control Block (data is updated based upon various trigger options)
- GOOSE (Generic Object Oriented Substation Event, data is updated based upon data change only)
- Control
- Time and time-synchronization
- Naming conventions

Part 8.1: MMS later in this document lists the data types supported by IEC 61850. This is important for understanding how data mapping in the gateway works. Other protocols do not all support the many data types that IEC 61850 does, so the IEC 61850 data is converted to an appropriate data type in the other protocol. As an example, for the Modbus protocol, much of the IEC 61850 data will be converted to 16-bit integer words.

8.4.1 Application Association Model

This section describes the gateway's implementation of IEC 61850-72- Clause 7: Application association model. This clause describes how the association between two devices is achieved:

- Two-Party-Application-Association
and/or
- Multicast-Application-Association

Both types are used.

Two Party Messaging

Two Party messaging is the most common type of messaging our IEC 61850 driver performs. The following diagrams show the execution of two-party messages, and their associated abort sequence. In the diagrams, the IEC 61850 client driver is the client. This information and diagrams have been taken directly from the IEC 61850 standard.

The services for associate, data exchange, and association release of the two-party application association class is depicted in Figure 7.

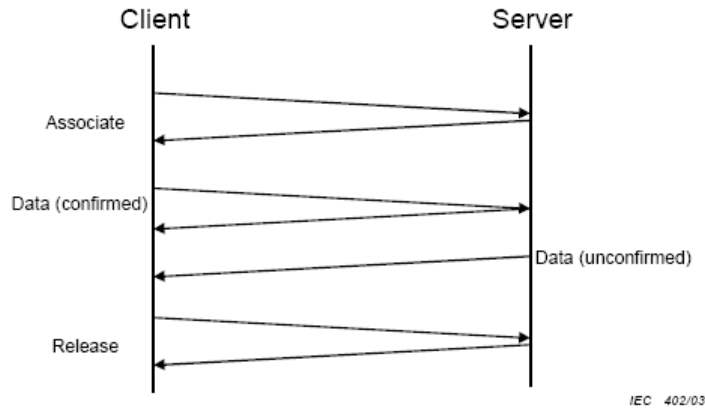

Figure 7 – Normal operation

The abort service for the two-party application association class is depicted in Figure 8.

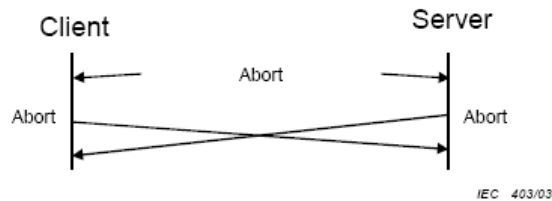

Figure 8 – Aborting association

Two party messages use these services: Associate, Abort, and Release.

For **TWO-PARTY-APPLICATION-ASSOCIATION** the following services are defined.

Service	Description
Associate	Establish an association
Abort	Abort an association
Release	Release an association

Multicast

Multicast information exchange is performed between a source (publisher) and one or more destinations (subscribers). For the IEC 61850 protocol, this is known as GOOSE and GSSE messages. See the ACSI Service Conformance Statement later in this document, with the AA (Application Association) column marked with MC (Multicast). This diagram has been taken directly from the IEC 61850 Standards document.

The subscriber shall be capable to detect loss and duplication of information received. The receiver shall notify the loss of information to its user and shall discard duplicated information.

NOTE The possible restriction of multicast messages to be exchanged on a single subnet or sent through routers is an issue to be defined in an SCSM.

The multicast application association class is depicted in Figure 9.

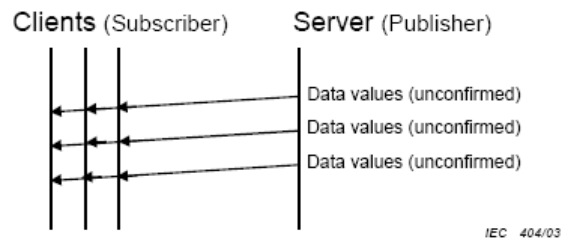

Figure 9 – Principle of multicast application association

8.4.2 DATA-SET

The DATA-SETS are important for Buffered Report Control Blocks (BRCBs), Unbuffered Report Control Blocks (URCBs), and GOOSE Control Blocks. These Report Control Blocks (RCBs) reference a DATA-SET to know what data to send to the IEC 61850 client. For some IEDs, the DATA-SET may be:

- Static
- Dynamic
- Optionally not reported in its entirety

This variability is based on features of specific IEDs. The ProSoft MNET-61850 Configuration Manager does not allow you to dynamically create a DATA-SET on the IED.

The definition of a DATA-SET is the group of Data Attributes that make up the DATA-SET. DATA-SETS (if they exist) are defined as part of the IED's configuration, as provided by the IED manufacturer.

The assignment of the DATA-SET to a BRCB, URCB, or GOOSE Control Block is set on the IED. These DATA-SET definitions are currently outside the scope of the gateway. See the BRCB, URCB, and GOOSE sections of this document to understand how DATA-SETS are used by the gateway, and for examples. This table has been taken directly from the IEC 61850 Standards document.

For **DATA-SET** the following services are defined.

Service	Description
GetDataSetValues	Retrieve all values of DATA referenced by the members of the DATA-SET
SetDataSetValues	Write all values of DATA referenced by the members of the DATA-SET
CreateDataSet	Create a DATA-SET by providing the FCD (FCDA) references or that form the DATA-SET
DeleteDataSet	Delete a DATA-SET
GetDataSetDirectory	Retrieve FCD references of all members referenced in the DATA-SET

8.4.3 Report Control Block

This section describes the gateway's implementation of IEC 61850-7-2 Clause 14: REPORT-CONTROL-BLOCK.

Log and logging is not supported at this time.

The Report Control Block (RCB) is made available to you through the ProSoft MNET-61850 Configuration Manager. The parsing of the CID/SCD file discovers the ReportControl element, which is unique within the Logical Node (LN). The ProSoft MNET-61850 Configuration Manager presents the ReportControl items to you, for you to map to the other protocol in the gateway if required or desired. There are two types of Report Control Blocks (RCBs):

- Buffered Report Control Blocks (BRCB)
- Unbuffered Report Control Blocks (URCB)

Supported Report Control Block Features

- RptEnabled
- TrgOps

When the gateway is configured to use an IED's report, after the gateway establishes a connection with the IED, it turns on **RptEnabled**. The gateway then receives the reports it's configured to receive.

TrgOps tells the gateway which internal event produces the inclusion of a DATA-SET member onto a report. TrgOps options are:

- Data change (dchg)
- Quality change (qchg)
- Data update (dupd)
- General Interrogation

The reason for inclusion of a piece of data in the report is because the IED is dependent upon the TrgOps (Trigger Options) in the CID/SCD file.

Report Control Block Services

There are three typical RCB services:

- Report
- GetBRCBValues
- SetBRCBValues

The process starts with the client issuing a **RptEna** (report enable), as follows. This diagram has been taken directly from the IEC 61850 Standard document.

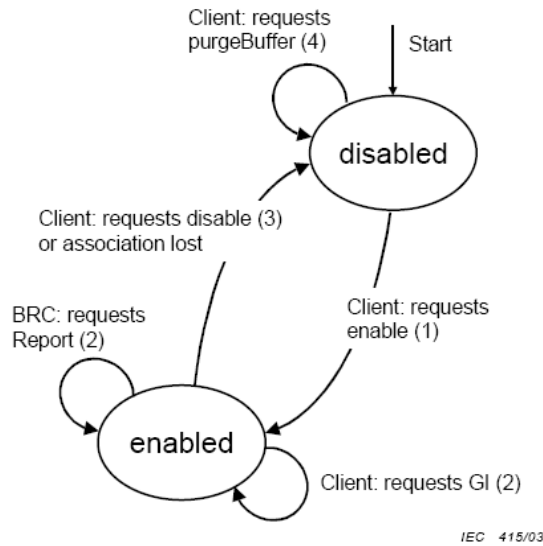

Figure 20 – BRCB state machine

The Report service is used by the BRCB to send reports from the server to the client. Transmission is unconfirmed, meaning there is no validation check at the client or acknowledgement from the client back to the server. This table has been taken directly from the IEC 61850 Standard document.

Table 24 – Report format specification

ReportFormat		
Parameter name	Parameter type	Explanation
RptID	VISIBLE STRING65 ^a	Report identification
OptFlds	^a	Optional fields to be included in the report
IF sequence-number = TRUE in optFlds		
SqNum	INT16U	Sequence number
SubSqNum	INT16U	Subsequence number
MoreSegmentsFollow	BOOLEAN	More report segments with the same sequence number follow
IF dat-set-name = TRUE in optFlds		
DatSet	ObjectReference ^a	Data set reference
IF buffer-overflow = TRUE in optFlds		
BufOvfl	BOOLEAN	TRUE shall indicate that a buffer overflow has occurred.
If conf-revision = TRUE in optFlds		
ConfRev	INT32U	
Entry		
IF report-time-stamp = TRUE in optFlds		
TimeOfEntry ^b	EntryTime	
IF entryID = TRUE in optFlds		
EntryID ^b	EntryID	
EntryData [1..n]		
IF data-reference = TRUE in optFlds		
DataRef	ObjectReference	Respective DataAttrRef
Value	(*)	(*) type(s) depend on the definition of common data classes in IEC 61850-7-3
ReasonCode	TriggerConditions	If reason-for-inclusion (= TRUE) in optFlds
^a The type and value of this parameter shall be derived from the respective attribute of the BRCB .		
^b TimeOfEntry and EntryID shall be available only if both report-time-stamp = TRUE AND entryID = TRUE in optFlds.		

RptID is derived.

The entire contents of Table 24 is not created as tags and therefore not brought over to the other protocol. Only the Tag Names (mapped Data Attributes) are available to the other protocol. Although the IED buffers data changes, only the most recent data values sent by the IED are processed by the gateway.

Buffered Report Control Block

The BRCB report controls are used by a client implementing a well-defined functionality, for example, a SCADA master. If the IEC 61850 client cannot access the report, it's probably due to access control. When one BRCB for the IED is in use, no other clients may access it.

The configuration file gives the IEC 61850 client driver the following:

- Domain Name
- Data Path
- Report ID
- Enable Flag
- Intpd
- Confrev
- Trgopdchg
- Tag Names

The Tag Names are a list of the Data Attributes as defined by the DATA-SET for the report. The ProSoft MNET-61850 Configuration Manager parses through the DATA-SET definition to determine the lowest level of the Data Attributes contained in it and creates those tags in the configuration file with the proper data type. You can choose which elements of the DATA-SET are mapped to Modbus.

For those DATA-SET Data Attributes that are not mapped, the ProSoft MNET-61850 Configuration Manager creates dummy tags as place holders for those Data Attributes. The dummy tags take up space in the tag database, even if they are not mapped to the Modbus TCP/IP driver.

The IEC 61850 driver processes report data from the IED by offsets, not by actual Data Attribute name. If the DATA-SET on the IED changes, you must re-import the CID/SCD file into the ProSoft MNET-61850 Configuration Manager to reconfigure the gateway, so that the gateway's internal processing of the report is done correctly.

If the BRCB is mapped in the gateway's configuration, then the IEC 61850 driver automatically turns on the Report Enable (RptEna) for the IED's BRCB.

Unbuffered Report Control Block

URCB data is sent immediately to the connected IEC 61850 client. If the transport data flow is not fast enough to support the movement of this data, some may be lost. The IED can have multiple instances of the URCB data, and in this case, the IED server manages the separation of the instances transmitted to the IEC 61850 clients.

- If a URCB is mapped in the gateway's configuration, then the IEC 61850 driver automatically turns on the Report Enable (RptEna) for the IED's URCB.
- The unbuffered reports is sent automatically from the IED to the gateway while Report Enable is on.
- The IEC 61850 driver and configuration software implements URBCs the same as BRCBs.

Unsupported Report Control Block Features

OptFlds are the optional fields that the IED can include in the report:

- Sequence number
- Report time stamp
- Reason for inclusion
- Data set name
- Data reference
- Buffer overflow
- entryID

The gateway only updates the value of the tags (**Data Attributes**) in the tag database.

The optional fields from the reports are not stored in the tag database, and unsupported.

8.4.4 GOOSE Control Block

Below is the GOOSE control block class definition. This table has been taken directly from the IEC 61850 Standard document.

GOOSE control block class definition

GoCB class				
Attribute name	Attribute type	FC	TrgOp	Value/value range/explanation
GoCBName	ObjectName	GO	-	Instance name of an instance of GoCB
GoCBRef	ObjectReference	GO	-	Path-name of an instance of GoCB
GoEna	BOOLEAN	GO	dchg	Enabled (TRUE) disabled (FALSE)
AppID	VISIBLE STRING65	GO		Attribute that allows a user to assign a system unique identification for the application that is issuing the GOOSE. DEFAULT GoCBRef
DatSet	ObjectReference	GO	dchg	
ConfRev	INT32U	GO	dchg	
NdsCom	BOOLEAN	GO	dchg	
Services				
GetGoReference				
GetGOOSEElementNumber				
GetGoCBValues				
SetGoCBValues				

The only TrgOp (trigger options) is dchg (data change). So GSE data is being passed from the publisher to the subscriber only:

- a) When the IED first enters the network.
- b) When the data changes on the publisher.

You can set up GOOSE messages in the IEDs for only that data needs to be sent to the gateway. That way, GOOSE messages contains only needed data.

Below is the GOOSE message format. This table has been taken directly from the IEC 61850 Standard document.

Table 29 – GOOSE message definition

GOOSE message		
Parameter name	Parameter type	Value/value range/explanation
DatSet	ObjectReference	Value from the instance of GoCB
AppID	VISIBLE STRING65	Value from the instance of GoCB
GoCBRef	ObjectReference	Value from the instance of GoCB
T	EntryTime	
StNum	INT32U	
SqNum	INT32U	
Test	BOOLEAN	(TRUE) test (FALSE) no-test
ConfRev	INT32U	Value from the instance of GoCB
NdsCom	BOOLEAN	Value from the instance of GoCB
GOOSEData [1..n]		
Value	(*)	(*) type depends on the common data classes defined in IEC 61850-7-3. The parameter shall be derived from GOOSE control

Although this entire GOOSE message is received, the gateway only stores GOOSEData [1..n] in the tag database.

GOOSE Messages

The gateway implements GSE messages according to IEC 61850-7-2 Clause 15.

The IEC 61850 driver acts as a client, subscribing to the messages. The IEDs act as a servers, publishing the messages.

GSE messages can help activate equipment safety interlocks (the IED prevents harming the operator or itself).

GOOSE Priority

The gateway gives GOOSE messages processing priority over other IEC data messages. If a GOOSE message is received, the GOOSE message is processed ahead of all other data transfer (MMS, Reporting) in the gateway at that moment.

GOOSE Subscription Status

The gateway's GOOSE subscription verifies match of confRev in a manner identical to the verification performed when enabling a report.

If the confRev does not match (unavailable, wrong type, different value), then the GOOSE is not subscribed and an Event is logged in the Event Logger describing the reason. If the data type of confRev fetched from the IEC device is not **RT_UNSIGNED**, then no event is logged.

The command, **confRev** must match what is running in the IED when the gateway comes on-line with the current configuration, or the gateway does not successfully subscribe to the GOOSE message.

The gateway does not check for a match of the GOOSE AppID from the CID file to the actual running IED when performing a GOOSE subscription.

IED Disconnect/Reconnect

If for any reason an IED disconnects from the network, the gateway continually polls for the device and attempt to reconnect.

8.4.5 Control

Operate

Used by Direct control with normal security, SBO control with normal security, Direct control with enhanced security, and SBO control with enhanced security to write data to IED devices.

In the case where the logical node has (for example) **Pos** data that has **SBOw**, **Oper**, and **Cancel**, you need to map the **Oper** structure only when wanting to control that data. SBOw, Oper, and Cancel all refer to controlling the same Data Attributes on the IED. The gateway automatically handles the select with value. So although the SBOw and Cancel can be seen in the configuration software, they should not be mapped. Only the Oper should be mapped. The Cancel structure should only be mapped if it is required.

The IEC 61850 Oper Structure has Data Attributes as defined by the standard. When you make MMS Writes from the Modbus device to the IED, if you do not populate all data elements of Oper, the gateway by default populates the other data elements with 0 (zero). The exception to this is **T** which is always set to the current time in the gateway.

The IEC 61850 client driver needs to provide the following information to the IED. These Data Attributes are available for you to select and set. This table has been taken directly from the IEC 61850 Standard document.

The **Operate** service shall define the following service parameters.

Parameter name
Request
ControlObjectReference
Value
T
Test
Check
Response+
ControlObjectReference
Value
T
Test
Response-
ControlObjectReference
Value
T
Test
AddCause

ctlVal

This must be set for:

- SPC (Single Point Control)
- DPC (Double Point Control)
- INC (Controllable Integer Status)
- BSC (Binary Controlled Step Position Information)
- ISC (Integer Controlled Step Position Information)
- CDCs (Common Data Classes)

This next section has been taken directly from the IEC 61850 Standard document.

17.5.2.2 Value

The parameter **Value** shall include values for all implemented **DataAttributes** of a controllable common **DATA** class that are accessed by various control services.

NOTE Common **DATA** classes and their **DataAttributes** are defined in IEC 61850-7-3.

EXAMPLE For the case of an **Operate** request, the value may include the following parameters:

- control value (on, off),
- originator category (remote, station, bay...),
- control sequence number.

setMag

- You must set this for APC (Controllable Analogue Set Point Information) CDC.

operTm

- The PLC user sends a command with operate time to the gateway, and the gateway uses time activated control, e.g. it sends the time of operation to the IED. The IED needs to support the time activated control.

origin.orCat

- The **orCat** could have these values. The value depends upon the role of the PLC. E.g. if the PLC is a station control, then this value never changes.

not-supported	orCat is not supported
bay-control	Control operation issued from an operator using a client located at bay level
station-control	Control operation issued from an operator using a client located at station level
remote-control	Control operation from a remote operator outside the substation (for example network control center)
automatic-bay	Control operation issued from an automatic function at bay level
automatic-station	Control operation issued from an automatic function at station level
automatic-remote	Control operation issued from an automatic function outside of the substation
maintenance	Control operation issued from a maintenance/service tool
process	Status change occurred without control action (for example external trip of a circuit breaker or failure inside the breaker)

origin.orIdent

- This is the address of the originator. The value you want depends upon the role of the PLC.

ctlNum

- This is of no consequence to the IED and only appears in reports. This is an optional parameter. The ctlNum may be of interest to you when the client uses the same control number for a complete control sequence: select, operate, ...

T

- This is the time the IEC 61850 client sent the control request. The IEC 61850 client driver writes this value using the current gateway time. This table has been taken directly from the IEC 61850 Standard document.

17.5.2.3 T – control time-stamp

The parameter **T** shall be the time when the client sends the control request.

Table 36 – Control time-stamp definition

Control time-stamp type		
Attribute name	Attribute type	Value/value range/explanation
T	EntryTime	

Test

- Test issues are still early in IEC 61850 use. This is only required if the customer really wants to issue a control command which should be interpreted by the IED as a command that should not cause a real operation.

Check

- Your specific application determines if or how this parameter is used. This parameter determines whether control actions are done immediately without interlock or synchrocheck, or if an interlock or synchrocheck is performed before the operation is done. Some other part of your application may do these checks anyway, even if checks are not used here. You can set the PLC to always use or always not use checks, or it can enable or disable checks for each control action when the control message is sent. This table has been taken directly from the IEC 61850 Standard document.

17.5.2.5 Check – check condition

The parameter **Check** shall specify the kind of checks a control object shall perform before issuing the control operation if common **DATA** class is **DPC** (double-point control – see IEC 61850-7-3).

Table 38 – Check condition definition

Check condition type		
Attribute name	Attribute type	Value/value range/explanation
Check	PACKED LIST	
synchrocheck	BOOLEAN	TRUE means run synchrocheck
interlock-check	BOOLEAN	TRUE means run interlock-check

IEC 61850 MMS Write

This covers the gateway's implementation of IEC 61850-7-2 Clause 17: CONTROL Class model (Writable Data).

The IEC 61850 driver is able to write to some IED Data Attributes. The writable Data Attributes are those that are identified in the ICD file with control classes of:

- Direct with normal security
- Select Before Operate (SBO) with normal security
- Direct with enhanced security
- Select Before Operate (SBO) with enhanced security

Control with normal security is for Data Attributes in which the client does not receive failure information. This implies that there would not need to be any action taken by a supervisory control on the system if the value of the Data Attribute did not change to the value the IEC 61850 driver was trying to write to it. The gateway receives an acknowledgment (**ack**) indicating if it worked or not.

The control function may optionally include a **Select** step, used to check that the control may be valid and to eventually lock a resource. **SBO-with-normal-security** and **SBO-with-enhanced-security** include the Select step. This is handled automatically by the gateway.

IEDs have certain filters in them that check that there is no damage if the control is issued. These functions are listed under "System control functions".

- **Control unity** (on the controlled item, in the bay, in the voltage level, in the substation).
- **Interlock validity**: Interlocking is a parallel function that delivers a status to enable or disable a control (if interlock is set to on). The control message may contain an interlock violation status to bypass it.
- **Synchrocheck validity**: When closing a breaker, the synchrocheck verifies some electrotechnical conditions and enable or disable the control.
- **Time validity**: The control contains a time attribute that specifies the time limit for issuing the control. This avoids issuing an old control that would have been stacked into the network.
- **Locked status**: A controlled item may be under lock status when the substation is partly in maintenance mode. This prohibits any control, for example, on a breaker if an operator is performing some repair on the line. Note that locking an item is an example of control.
- **Control privilege**: This is needed if an operator expects to control an item to check his privileges.
- **Substation and bay mode status**: The substation should be in remote mode to enable remote control (i.e. from SCADA) and in local mode to enable control issued inside the substation. The bay mode should be in remote mode to enable control from the station level or remote control level (SCADA).
- **State of the controlled item**: The control should lead the controlled item into an authorized state (for example, it is impossible to open an open disconnecter). When the controlled item is in an unknown state (for example, double point status have the same value), this filter is optionally suppressed.

Control is canceled if one of these filters is not verified or if a cancel order is received from the control point.

8.4.6 MMS

Part 8-1 of the protocol specification details the Specific Communication Service Mapping (SCSM), which is mapping of data to MMS (ISO 9506-1 and ISO 9506-2). The IEC 61850 driver is fully compliant to the MMS requirement.

In terms of the seven-layer OSI model, the new MMS stack looks like this:

Specification	Description
Application	Association Control Service Element (ACSE)- ISO 8649/8650
Presentation	Connection Oriented Presentation - ISO 8822/8823 Abstract Syntax Notation (ASN)- ISO 8824/8825
Session	Connection Oriented Session - ISO 8326/8327
Transport	ISO transport over TCP - RFC 1006 Transmission Control Protocol (TCP) - RFC 793
Network	Internet Control Message Protocol (ICMP) - RFC 792 Internet Protocol (IP)- Address Resolution Protocol (ARP)- RFC 826
Link	IP datagrams over Ethernet - RFC 894 MAC - ISO 8802-3 [Ethernet]
Physical	Ethernet

Data Types

Understanding the data types used by the PLX82-MNET-61850 is helpful for understanding data transfer for IEC 61850-7-2 Clause 14 (BRCB & URCB), 15 (GOOSE), and 17 (CONTROL). This table has been taken directly from the IEC 61850 Standard document.

Basic data types

The **BasicTypes** shall be as listed in Table 2.

Table 2 – BasicTypes

BasicTypes			
Name	Value range	Remark	Used by
BOOLEAN			IEC 61850-7-3 IEC 61850-7-2
INT8	-128 to 127		IEC 61850-7-3 IEC 61850-7-2
INT16	-32 768 to 32 767		IEC 61850-7-3 IEC 61850-7-2
INT24	-8 388 608 to 8 388 607	for TimeStamp type	IEC 61850-7-2
INT32	-2 147 483 648 to 2 147 483 647		IEC 61850-7-3 IEC 61850-7-2
INT128	-2**127 to (2**127)-1	Required for counters	IEC 61850-7-3
INT8U	Unsigned integer, 0 to 255		IEC 61850-7-3 IEC 61850-7-2
INT16U	Unsigned integer, 0 to 65 535		IEC 61850-7-3 IEC 61850-7-2
INT24U	Unsigned integer, 0 to 16 777 215		IEC 61850-7-2
INT32U	Unsigned integer, 0 to 4 294 967 295		IEC 61850-7-3 IEC 61850-7-2
FLOAT32	Range of values and precision as specified by IEEE 754 single-precision floating point		IEC 61850-7-3
FLOAT64	Range of values and precision as specified by IEEE 754 double-precision floating point		IEC 61850-7-3
ENUMERATED	Ordered set of values, defined where type is used	Custom extensions are allowed	IEC 61850-7-3 IEC 61850-7-2
CODED ENUM	Ordered set of values, defined where type is used	Custom extensions shall not be allowed. Type shall be mapped to an efficient encoding in a SCSM	IEC 61850-7-3 IEC 61850-7-2
OCTET STRING	Max. length shall be defined where type is used ^a		IEC 61850-7-3 IEC 61850-7-2
VISIBLE STRING	Max. length shall be defined where type is used ^a		IEC 61850-7-3 IEC 61850-7-2
UNICODE STRING	Max. length shall be defined where type is used ^a		IEC 61850-7-3

^a The length suffix shall have the format "...STRINGnn" where "nn" is the length in characters.

EntryID

EntryID is 8 octet fixed length MMS OCTET STRING.

PACKED LIST

PACKED LIST is MMS Bit-string of variable length. Bit 0 is the leftmost (most significant) bit of the first octet. Bit 7 is the rightmost (least significant) bit of the first octet. Bit 8 is the leftmost (most significant) bit of the second octet. Bit 15 is the rightmost (least significant) bit of the second octet, etc. Exceptions to this are time and quality. This table has been taken directly from the IEC 61850 Standard document.

Table 15 – Encoding of IEC 61850-7-2 TimeQuality

Bit	Value	Meaning
0		Leap Second Known
1		ClockFailure
2		Clock not synchronized
3-7		Time accuracy of fractions of second
	00000	0 bit of accuracy
	00001	1 bit of accuracy
	00010	2 bits of accuracy
	00011	3 bits of accuracy
	00100 - 11000	Integer value of number of bits of accuracy
	11000- 11110	Invalid
	11111	unspecified

Bit 0 is the most significant bit of octet 7. Bit 7 is the least significant bit of octet 7. The octet format is (using ASN.1 bstring notation).

EntryTime

EntryTime is mapped as BINARY-TIME, and is six octets.

TriggerConditions

TriggerConditions, such as those used in BR CB, are encoded as a PACKED LIST, yet bit 0 is reserved.

- Bit 0 Reserved (reserved to provide backward compatibility with UCA 2.0)
- Bit 1 data-change
- Bit 2 quality-change
- Bit 3 data-update
- Bit 4 integrity
- Bit 5 general-interrogation

Quality

Quality is packed as 13 bits. This table has been taken directly from the IEC 61850 Standard document.

Table 16 – Encoding of IEC 61850-7-3 quality

Bit(s)	IEC 61850-7-3		Bit-String	
	Attribute name	Attribute value	Value	Default
0-1	Validity	Good	0 0	0 0
		Invalid	0 1	
		Reserved	1 0	
		Questionable	1 1	
2	Overflow		TRUE	FALSE
3	OutOfRange		TRUE	FALSE
4	BadReference		TRUE	FALSE
5	Oscillatory		TRUE	FALSE
6	Failure		TRUE	FALSE
7	OldData		TRUE	FALSE
8	Inconsistent		TRUE	FALSE
9	Inaccurate		TRUE	FALSE
10	Source	Process	0	0
		Substituted	1	
11	Test		TRUE	FALSE
12	OperatorBlocked		TRUE	FALSE

Functional Constraints

Each IEC 61850 Data Attribute has a Functional Constraint (FC), which shows what the data is or how it is used. For example, Data Attributes with FC=ST are status data. Data Attributes with FC=CO can be controlled.

You can see the Data Attributes Functional Constraints in the IEC Mapping Tool window, for example:

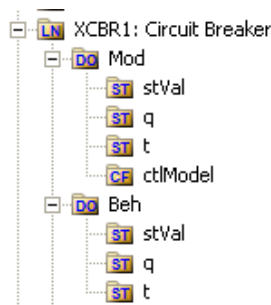

Note: The icons provide information. **DO** is for Data Object. Within the **DO**, there may be multiple levels of data. Down to the Data Attribute level, the functional constraint of the Data Attribute is shown in the icon, e.g. **CO** for Control, **ST** for Status Information, and **CF** for Configuration.

Here is the list of IEC 61850 Functional Constraints:

Functional Constraint	Description
ST	Status information
MX	Measurands (analog values)
CO	Control
SP	Setpoint
SV	Substitution
CF	Configuration
DC	Description
SG	Setting Group
SE	Setting group editable
EX	Extended definition
BR	Buffered report
RP	Unbuffered report
LG	Logging
GO	GOOSE Control
MS	Multicast sampled value control
US	Unicast sampled value control
XX	Represents Data Attributes as a service parameter. XX is a wildcard.

8.4.7 Modbus TCP/IP Server

The following is the Modbus TCP/IP server startup sequence.

- 1 Connect to Event Logger.
- 2 Connect to tag database – Error message in event log on fail.
- 3 Parse configuration file – Error message if cannot create configuration.
- 4 Connect to system tag database.
- 5 Initialize diagnostics.
- 6 Connect to MCP – Error message in event log on fail.
- 7 Create server pool.
- 8 Server pool creates a server thread for each configured server.
- 9 Inform MCP that driver is ready to run.
- 10 Wait for run signal from MCP.
- 11 Run server communications: wait for Client to connect.
- 12 If receives quit signal from MCP clean up threads and exit process.

Each client tries to connect repeatedly until the connection is made. If the attempt to connect fails, it waits 100ms and tries again. If a connection is lost, it starts trying to connect using the same sequence as during startup.

The server disconnects on connection loss or when there is no communication for a timeout period. It then listens for a connection request from a client.

8.4.8 IEC 61850 Client

The following is the IEC 61850 client startup sequence:

- 1 Verify process arguments from MCP.
- 2 Connect to the Event Log; upon success log Event.
- 3 Connect to System tag DB; upon failure log Event.
- 4 Initialize diagnostics.
- 5 Connect to User tag DB; upon failure log Event.
- 6 Connect to MCP Interface; upon failure log Event. Tell MCP Interface "not running", "not ready".
- 7 Parse configuration.
- 8 Verify all tag pointers from configuration for validity (tags all defined, all exist in User tag DB); upon first failure log Event.
- 9 Create internal file for configuration from our parsed configuration.
- 10 Initialize diagnostic tag pointers and diagnostic values.
- 11 Opens internal file and the GOOSE socket; upon failure of either log Event.
- 12 Prepare reportids; upon failure log Event.
- 13 Tell MCP Interface ready.
- 14 Start the Diagnostics thread.
- 15 Initialize global GOOSE management.
- 16 Tell MCP Interface running.

All conditions causing the driver not to start are identified above by the log Event actions.

IEC 61850 client firmware operating sequence:

- 1 If not connected to a configured IED, attempt to connect every 5 seconds. Once connected, attempt to identify with the IED every 50 ms. If identify fails 10 times, disconnect from the IED and attempt to reconnect every 5000 ms.
- 2 Subscribe to any GOOSE messaging configured for this IED. Ensure match of each element's type id and the GOOSE confRev. Set failure flag if no match is found.
- 3 Enable any Reports configured for this IED. If the enable fails for whatever reason, such as a mismatch of confRev, then the Report is not enabled and not attempted again. Otherwise the Enable continues to be attempted every 60 seconds. Once connected, perform a General Interrogation to receive all data values of the Report, if that TrgOp was enabled for that Report. Once connected, perform a General Interrogation to receive all data values of the Report, if that TrgOp was enabled for that report.
- 4 Process MMS reads and MMS writes.

The IEC 61850 client driver attempts to reconnect to any disconnected IEDs every 5000 milliseconds.

Configured GOOSE messages for an IED are not re-subscribed upon a reconnect. There is no need, because GOOSE messages are of an EtherType packet, not an IP packet. GOOSE messages are addressed by MAC address, not IP address. Essentially it is a broadcast message.

Configured Reports for an IED return to a **Must try to Enable** state, and follow the startup sequence.

If MMS Reset (meaning the stream is out of step) is issued by either the gateway or the IED, then the gateway issues a disconnect and reconnect to the IED. If the IEC 61850 driver receives a short packet (short MMS read) then it issues a MMS Reset.

8.5 Processing the Commands

The command processing options are:

- **Continuous polling** - Messages are issued to the server each time the command is next on the polling list.
- **Timed polling** - Commands issue a message when the time has expired and the command is the next command in the polling list.
- **Data change event** - Commands are loaded into a queue when any value in a tag mapped to the command changes. The queue is always checked before processing the scan list giving event commands a higher priority. IEC 61850 GOOSE data has priority over any other command processing.

Client tag mapping is command based. Each command has one tag mapped to the Modbus TCP/IP registers being written or read by the client. When reading registers from a server, the data returned in the response is placed in tags in the tag database. When writing registers to a server, the data is taken from tags in the tag database. This tag mapping is done at the individual command level. You map tags in the ProSoft MNET-61850 Configuration Manager.

8.6 IEC 61850 Standard Introduction

IEC 61850 is primarily focused on electrical utility stations and substations. Substations can be categorized as distribution or transmission substations. Distribution substations generally have feeder equipment in the voltage range of 30 kV and under. The one or two incoming feeders are generally at a transmission voltage level. A transmission substation would have feeder equipment at a transmission voltage level, generally 100 kV and above.

Although IEC 61850 applications are primarily in electrical substations, there are applications in the oil and gas industries as well (co-gen sites).

8.6.1 Integrating the Substation

The logical nodes can inter-operate with other logical nodes by interpreting and processing compatible services and data classes. This table has been taken directly from the IEC 61850 Standard document.

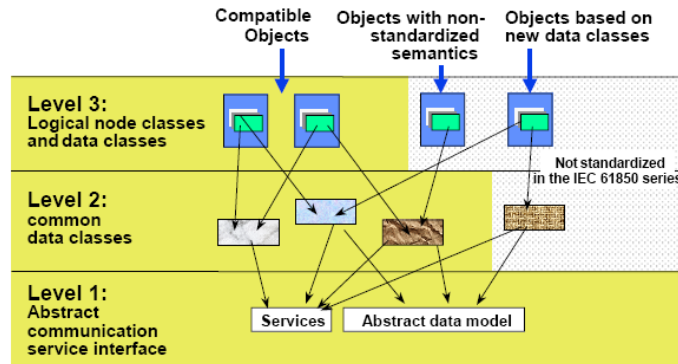

Typical Substation Automation System. This diagram has been taken directly from the IEC 61850 Standard document.

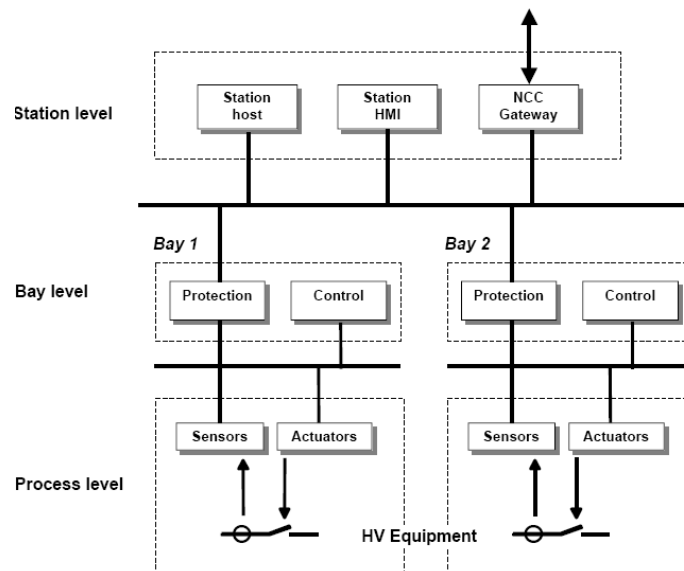

- In a typical substation, all Data Attributes from each of the IEDs are desired at the PLC.
- Data is desired at the Station PLC (for decision making) and at the SCADA.
- Data gathered for condition based monitoring purposes, to detect point of degradation of an aging mechanism.
- Examples of data needs: checking SF₆ gas insulation temperature.
- Alarm data with high precision of accuracy needed, to determine which IED alarmed (GOOSE'd) first.
- Control of bay-level switchgear for interlocking and maintenance purposes.

8.6.2 IEC 61850 Benefits

- Object-oriented data model
- Introduces Logical Nodes (LNs) for formally defining functions (for example XCBR = Circuit Breaker, XSWI = Isolator or earthing switch)
- LN defines standardized access to its data
- Performance guidelines per LN strongly influence the communication system structure
- Communication technology based upon standardized rules, not rules stated by chance by customer specifications
- Strong formal description of automation system, which is key for specification, design, and engineering
- Self-describing (Example: vendor name plate information)

8.6.3 IEC 61850 Communication Features

- Specific Communication Service Mapping (SCSM) is done via MMS (ISO/IEC 9506-1 and ISO/IEC 9506-2) and to ISO/IEC 8802-3. This is part IEC 61850-8-1 of the standard.
- Specific Communication Service Mapping (SCSM) for Sampled Values is over ISO/IEC 8802-3. This is part IEC 61850-9-2 of the standard.

Ethernet has proven performance for the demands of IEC 61850. For best performance, it is recommended that you use Ethernet switches, rather than hubs.

8.6.4 SCL / Standardized Data Exchange

IEC 61850's SCL (Substation Configuration Description Language) introduces a powerful feature for substation automation. It provides a vendor-independent representation of the substation's configuration. For example, XCBR is a circuit breaker, no matter who the vendor is, what the country the vendor is from, what country the system integrator is from, where the installation is.

IEC 61850 has a number of SCL-type files:

- SSD for substation specification description
- SCD for the substation configuration description
- ICD for IED capability description (like a configuration template for the IED)
- CID for the configured IED description

Note: This concept is key for meeting engineering challenges.

8.6.5 Additional Advantages to Substation Configuration Description Language (SCL)

- ICD files list the functionality (via Logical Nodes) and data objects (Data Attributes) available for the IED
- The device's ICD files list the communication service capabilities of the IED, for example, is File Transfer supported?
- The ICD tells what's in the DATA-SETS.
- It lists the Report Control Blocks, and if the DATA-SET for it can be dynamically assigned.
- When gathering data from the IED for archiving purposes, the database is simply built because of the descriptive names coming from the devices.

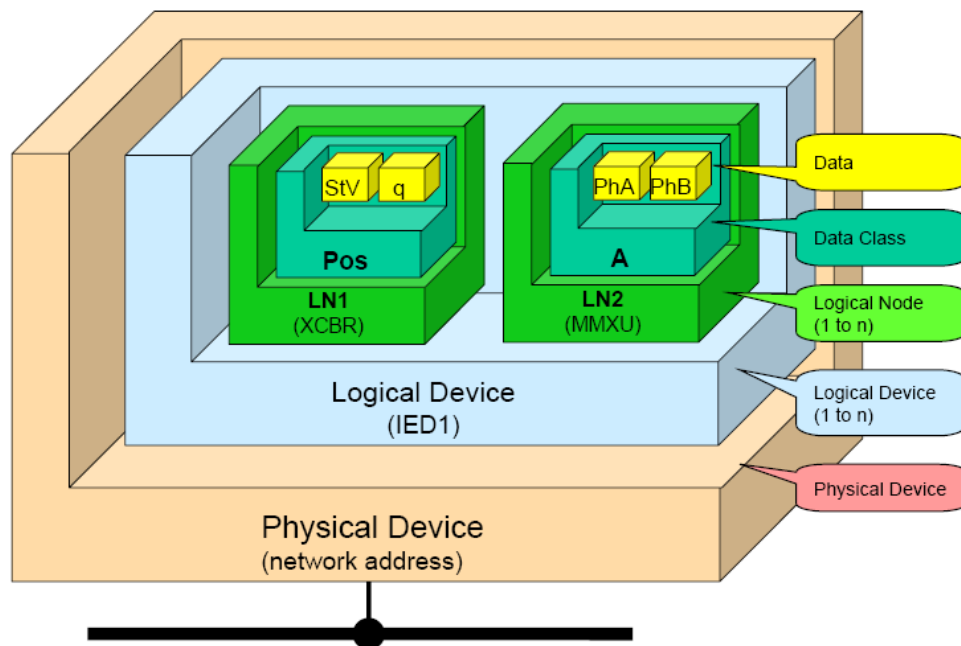

© Siemens Power Transmission & Distribution, 2002

14

IEC 61850-7-2 Overview Diagram

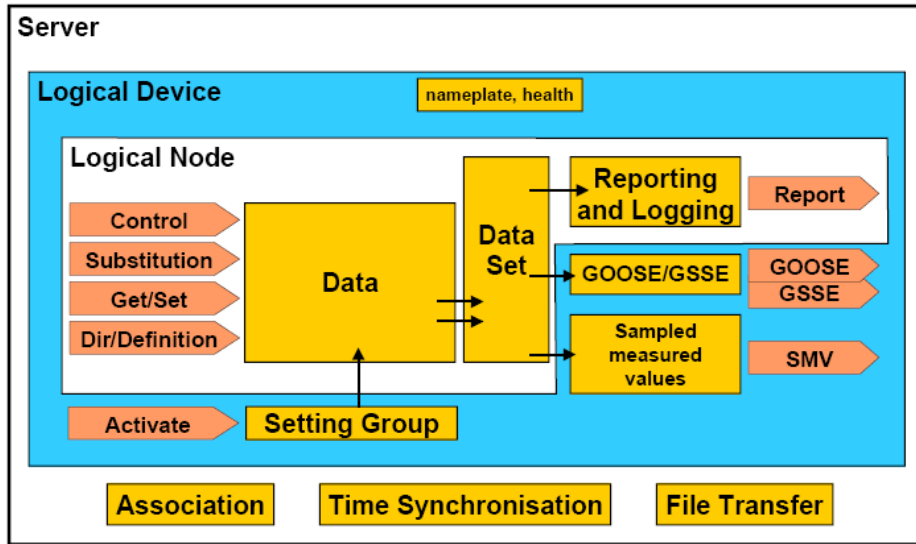

IEC 964/03

Information Exchange Diagram

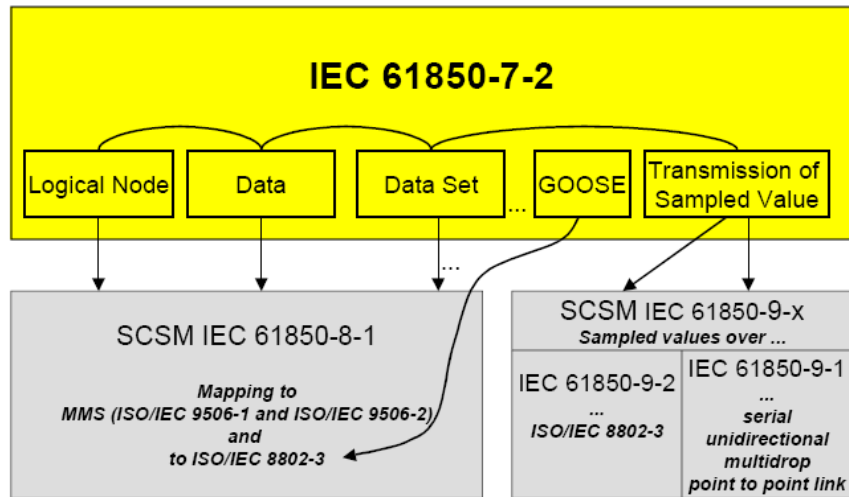

IEC 976/03

These diagrams have been taken directly from the IEC 61850 Standard document.

8.6.6 Report Control Block BRCB (Clause 14)

Buffered Report Control Block (BRCB)

A Buffered Report Control Block (BRCB) is associated with a DATA-SET. BRCB data is queued up, or buffered, in the IED, and sent sequentially to the connected IEC 61850 client. The size of the buffer is defined by the IED. BRCB is used so that data is not lost due to communication control or loss of connection. There are procedures required around the reporting, and the IED may only report to one client.

Unbuffered Report Control Block (URCB)

An Unbuffered Report Control Block (URCB) is associated with a DATA-SET. URCB data is sent immediately to the connected IEC 61850 client. If the transport data flow is not fast enough to support the movement of this data, some may be lost. The IED can have multiple instances of the URCB data, and manages the separation of the instances to the IEC 61850 clients.

8.6.7 GSE (Clause 15)

Peer-to-peer messaging is accomplished with two messages types that are slightly different. The messages, GOOSE and GSSE, are collectively referred to as GOOSE. They are accomplished via a publisher-subscriber model. The difference is that GOOSE data is exchanged via DATA-SET and GSSE provides a simple list of status information. The gateway supports GOOSE messages only. As an IEC 61850 client, the PLX82-MNET-61850 subscribes to the GOOSE messages published by the IED. GOOSE messages can help the equipment prevent interlock (the IED prevents harming the operator or itself).

8.6.8 Control (Clause 17)

There are 5 types of control models defined:

- Status-only
- Direct-with-normal-security
- Select Before Operate SBO-with-normal-security
- Direct-with-enhanced-security
- Select Before Operate SBO-with-enhanced-security

Enhanced Security tends to be used only for high-voltage sites.

SBO includes a Select step, used to check that the control may be valid and to eventually lock a resource.

Direct Control with Normal Security

Direct control with normal security is commonly used for operations that act on local data (such as a LED test) or on data for which return information is not supervised (for example switch on a heating). It uses the **Operate** and **TimeActivatedOperate** services. This diagram and text has been taken directly from the IEC 61850 Standard document.

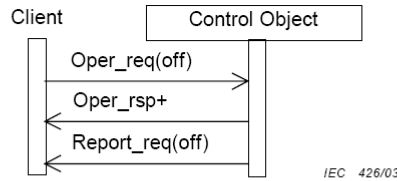

Figure 31 – Direct control with normal security

Procedure

On receipt of an **Operate** request, the control object shall check validation of the control execution.

- If not successful, the control object shall issue a negative response to the requesting client.
- If successful, the control object shall issue a positive response to the requesting client and causes the requested action.

The new status may be reported by the **Report** service (see reporting model).

SBO (Select Before Operate) with Normal Security

SBO control with normal security first verifies that the Data Attribute is not currently selected by a different client, that it is operable, and that the operation is not restricted. If this is verified, then the Operate request should proceed. It uses these services:

- Select
- Cancel
- Operate
- TimeActivatedOperate

SBO with normal security Data Attributes are generally controllable single point (SPC) attribute types. These are things such as:

- Run Diagnostics
- Trigger recorder
- Reset recorder memory
- Clear memory

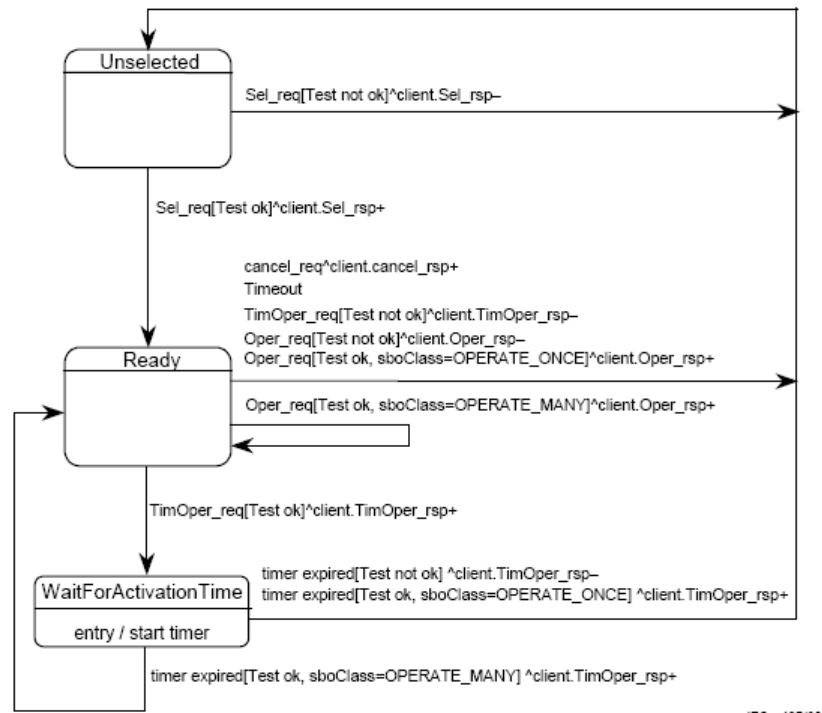

NOTE This state machine is compatible to the SBO control model defined in UCA™.2.

Figure 32 – State machine of SBO control with normal security

Procedure

- a) On receipt of a **Select** request, the control object shall determine if the client has appropriate access authority, that the control object is not currently selected by a different client, and that the device represented by the associated **LOGICAL-NODE** is operable and is not tagged so as to restrict operation.
 - If the **Select** operation is not valid, the control object shall issue a negative response to the requesting client.
 - If the **Select** operation is valid, the control object shall issue a positive response to the requesting client, shall change the state to ready and starts a deselect timer for either the interval defined by the SelTimOut attribute or, if unimplemented, some locally determined duration.
- b) If the deselect timer expires before an **Operate** request on one or more of the other control components shall be requested by the selecting client, the control object shall change the state to unselected.
- c) If an **Operate** request is received from the selecting client while the state is not Ready for that client, the operation shall be denied.
- d) On receipt of an **Operate** request, the control object shall check validation of the control execution.
 - If not successful, the control object shall issue a negative response to the requesting client.
 - If successful, the control object shall issue a positive response to the requesting client and shall cause the requested action by activating a binary output (or sending an equivalent signal on a process bus). The control object shall turn to the state WaitForActivationTime.

This diagram and text have been taken directly from the IEC 61850 Standard document.

Direct Control with Enhanced Security

Direct control with enhanced security is commonly used to start actions at the server from a client. However, multiple clients can perform conflicting actions to the server without prevention in this model. It uses these services:

- Operate
- TimeActivatedOperate
- Command-Termination

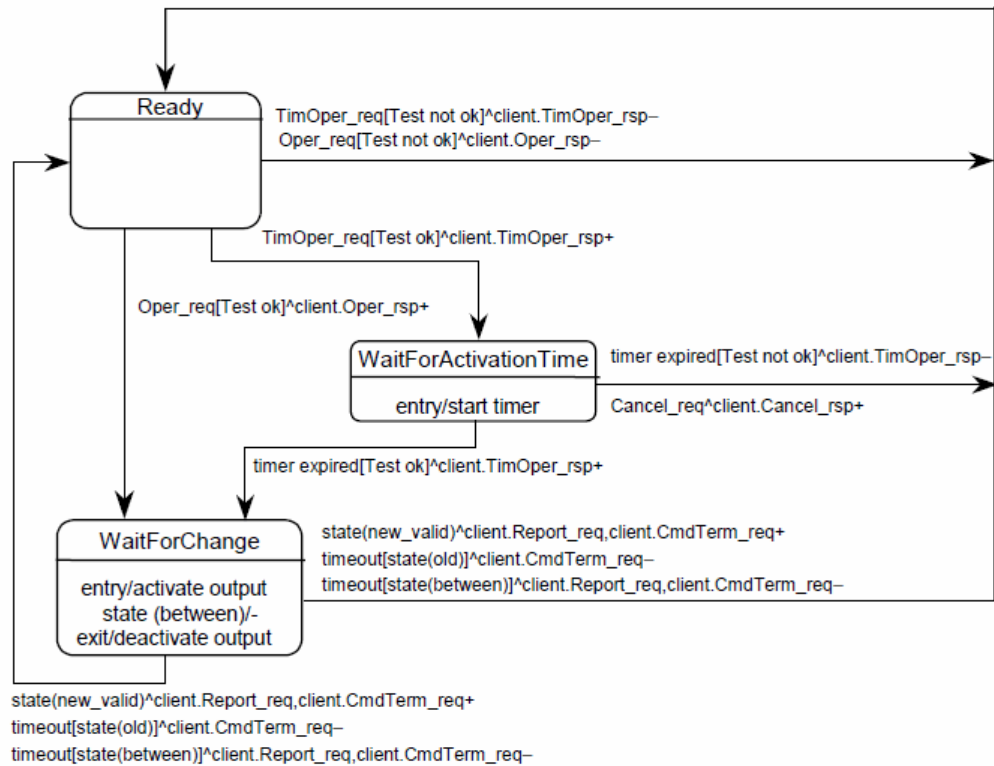

IEC 428/03

Figure 33 – State machine of direct control with enhanced security

This diagram has been taken directly from the IEC 61850 Standard document.

SBO (Select Before Operate) with Enhanced Security

SBO control with enhanced security is commonly used for allowing only one client to control the server at a time. It uses these services:

- SelectWithValue
- Cancel
- Operate
- TimeActivatedOperate
- Command-Termination

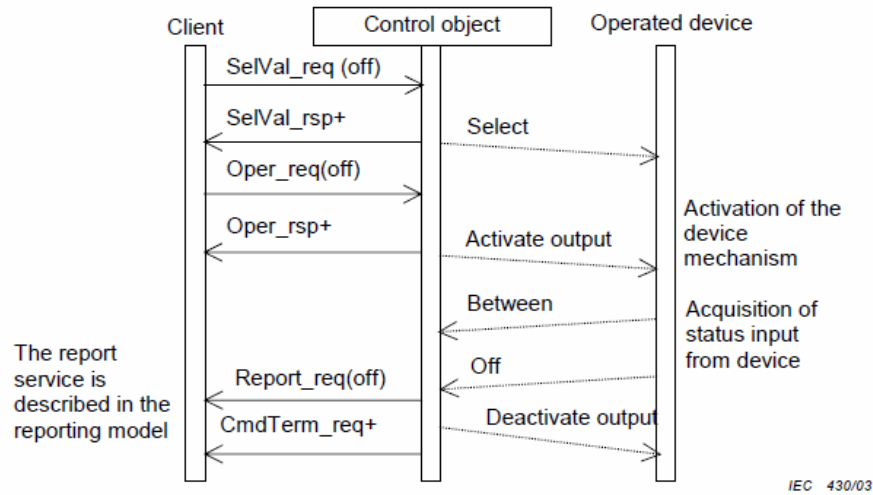

Figure 35 – Select before operate with enhanced security – positive case

NOTE The dashed lines in Figures 35 and 36 indicate that these “services” are local and not visible at the communication level.

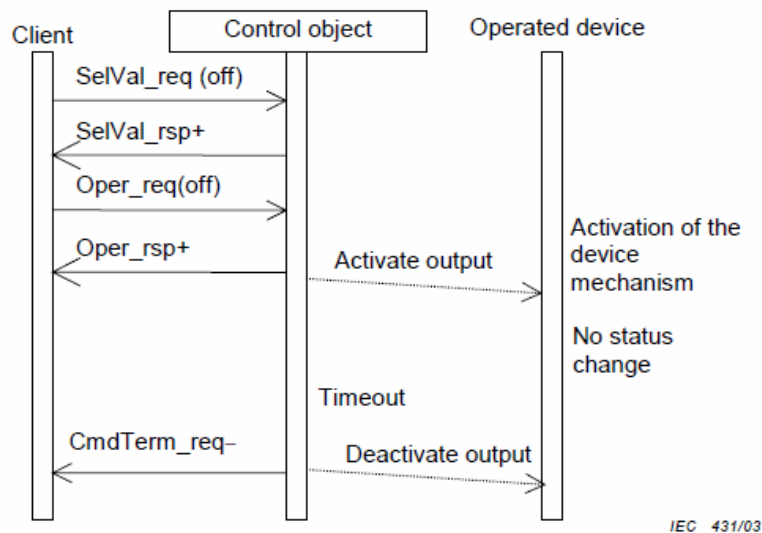

Figure 36 – Select before operate with enhanced security – negative case (no status change)

Procedure

- a) On receipt of a **SelectWithValue** request, the control object shall determine if the client has appropriate access authority, that the control object is not currently selected by a different client, and that the device represented by the associated **LOGICAL-NODE** is operable and is not tagged so as to restrict operation.
 - If the **SelectWithValue** operation is not valid, the control object shall issue a negative response to the requesting client.
 - If the **SelectWithValue** operation is valid, the control object shall issue a positive response to the requesting client, shall change the state to ready and starts a deselect timer for either the interval defined by the **sboTimOut** attribute or, if unimplemented, some locally determined duration.
- b) If the deselect timer expires before an **Operate** request on one or more of the other control components shall be requested by the selecting client, the control object shall change the state to unselected.
- c) If an **Operate** request is received from the selecting client while the state is not Ready for that client, the operation shall be denied.
- d) On receipt of an **Operate** request, the control object shall check validation of the control execution.
 - If not successful, the control object shall issue a negative response to the requesting client.
 - If successful, the control object shall issue a positive response to the requesting client and shall cause the requested action by activating a binary output (or sending an equivalent signal on a process bus). The control object shall turn to the state **WaitForChange**.
 - The control object supervises the change of the device status.
 - As soon as the status of the controlled device has changed, the control object shall report the new status using the report service of the reporting model.
 - If the status has not changed to the wanted value after a certain time, the control object shall issue a **CommandTermination** negative as soon as the output is deactivated.
 - When the object indicates the wanted position before expiration of a timer, the control object shall issues a **CommandTermination** positive as soon as the output is deactivated.
- e) When leaving the **WaitForChange** state, one of the following procedures shall be performed based on the **SBO-Select Class**.
 - If the value of the **sboClass** attribute is **operate-once**, the new state shall be unselected.
 - If the value of the **sboClass** attribute is **operate-many**, the new state shall be Ready.

The last action shall be the command termination (**CmdTerm**) service.

These diagrams and text have been taken directly from the IEC 61850 Standard document.

8.6.9 Time and Time Synchronization (Clause 18)

NTP provides for UTC synchronized time.

8.6.10 Naming Conventions (Clause 19)

This section discusses the gateway’s implementation of IEC 61850-7-2 Clause 19: Naming Conventions.

The ProSoft MNET-61850 Configuration Manager follows the naming conventions in accordance with the IEC 61850 standards, and they are also transferred into Modbus.

The *IEC 61850 Mapping Tool* window uses standard naming conventions:

- Logical Node
- Data Object
- Data Attribute
- Functional Constraint
- 61850 Path

Extended into:

- TagName

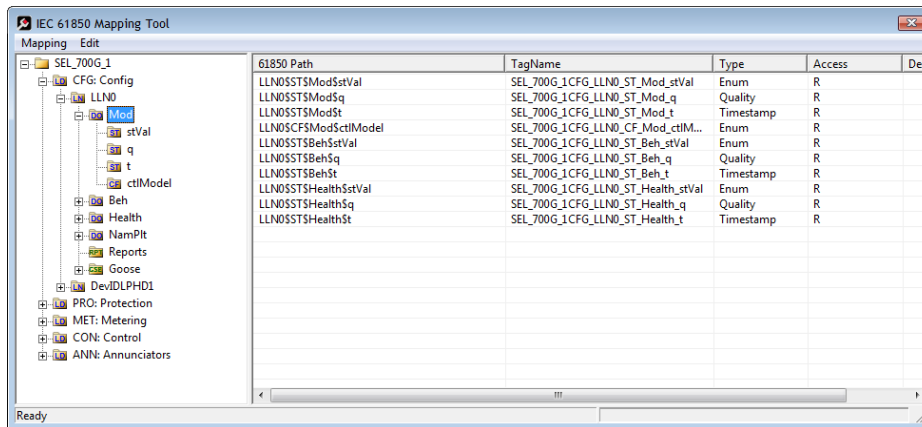

References to data for class naming and class specialization are as defined in the IEC 61850 Standard. They are:

The classes for **DATA**, **common DATA**, **compatible DATA**, and **compatible LOGICAL-NODE** defined in IEC 61850-7-x make use of the following specializations:

- IEC 61850-7-3 common **DATA** classes (for example, **DPC**) are specializations of the class **DATA** of IEC 61850-7-2
- IEC 61850-7-4 compatible **DATA** classes (for example, **Pos** – position) are specializations of IEC 61850-7-3 common **DATA** classes (for example, **DPC** – controllable double point)
- IEC 61850-7-4 compatible **LOGICAL-NODE** classes (for example, **XCBR**) are specializations of the **LOGICAL-NODE** class of IEC 61850-7-2

The preceding text has been taken directly from the IEC 61850 Standard document.

8.7 Usage Examples

8.7.1 Schneider Electric PLC/PAC Device Configuration

The PLX82-MNET-61850 is intended to work with and be highly integrated with Schneider Electric M340, Quantum, or Premium PLCs/PACs. The gateway creates files for the user to import into Unity Pro, Schneider Electric's PLC configuration software, to simplify setup and integration of the PLX82-MNET-61850 into Unity Pro.

The function block created by the ProSoft MNET-61850 Configuration Manager requires Quantum processor firmware version 2.6 or later. However, if the customer is using an NOE card for their Ethernet connection to the ProSoft gateway, then the processor firmware version does not matter.

8.7.2 Example: Energy Application

- The IEC 61850 protocol specification was written with electrical substations in mind.
- The PLC wants ALL DATA, including time stamp and quality bits from all IEDs. It will send this data to a dispatching system. In this case, the PLC is like a data concentrator from the substation to the dispatching center.
- User wants Open and Close control with tight time constraints. The controls need to be as fast as possible.

One typical example for this kind of application might be 20 IEDs, where the ProSoft gateway needs to send all the data from all 20 IEDs to the PLC. Typically, this would be approximately 50 data points per IED.

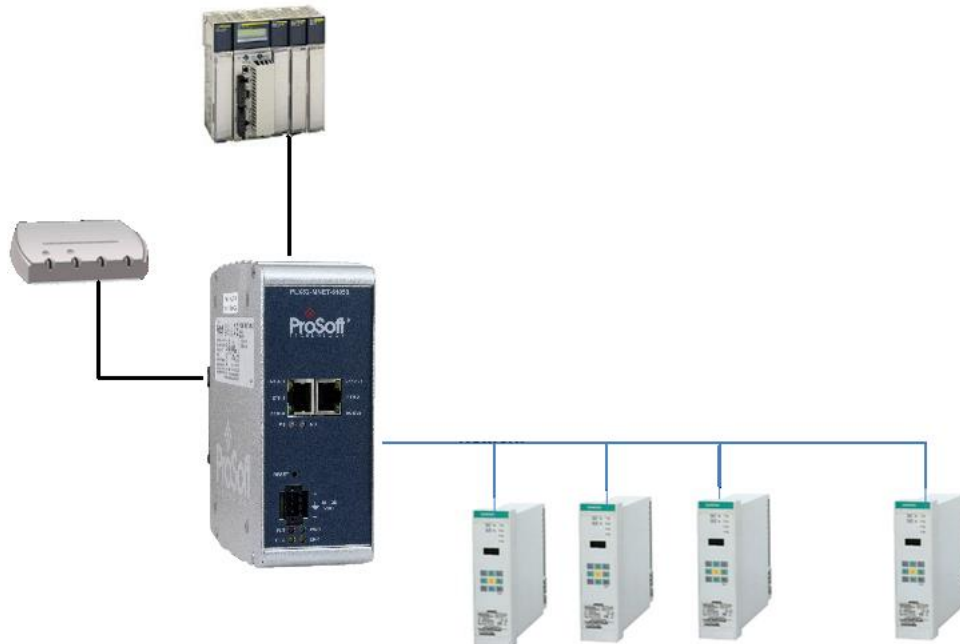

8.7.3 Example: Oil & Gas Application

- There is not much data that typically needs to be moved from each IED to the PLC in this type of application.
- In this example, the user may want to send commands from a process DCS system to control breakers.
- The PLC needs to transfer five to ten Data Attributes through the ProSoft gateway to each of many IEDs.

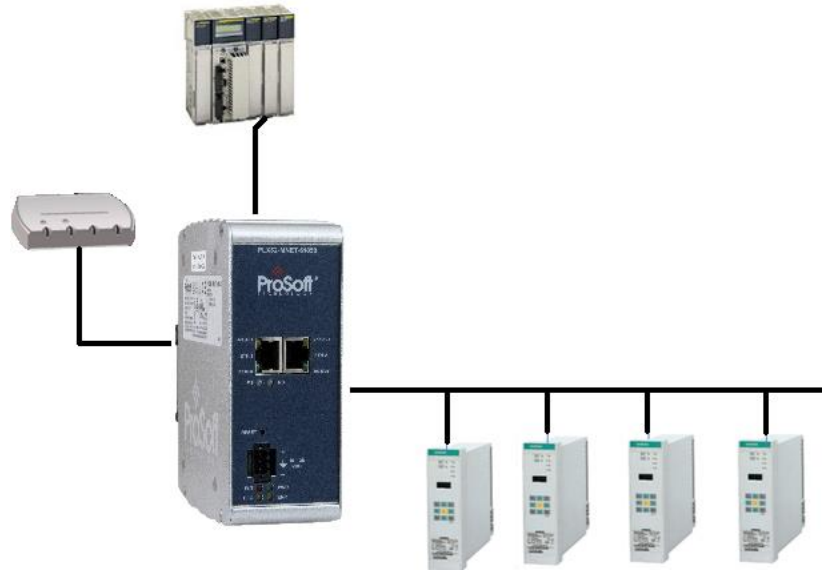

8.7.4 Monitoring

In a typical monitoring application, several types of actions may be needed:

- Automatic action required: monitoring the currents and voltages and the system taking an immediate automatic action, like tripping a circuit breaker.
- Operator action required: monitoring of the current temperature of gas in a gas insulator around a circuit breaker. This could result in actions initiated by an operator, such as sending maintenance people on-site.
- Post-mortem analysis: monitoring and collecting information about equipment condition, to be analyzed by a specific tool, resulting in recommendations for maintenance.

8.7.5 Measuring and Metering

Statistical evaluation of measured quantities, determining minimum and maximum values over a period of time, and creating history of this information, such as:

- Currents, voltage, power and impedance in a three phase system (MMXU)
- Calculation of energy in a three phase system (MMTR)
- Calculation of harmonics and interharmonics (MHAI)

8.7.6 Supervision and Protection

Evaluating measured quantities for the purpose of detecting dangerous situations, such as

- Supervision of the quantities of an insulation medium in Sxxx logical nodes (Sxxx = logical nodes for monitoring by sensors = **SIMS, SARC, and SPDC**)
- Processing of quantities in Pxxx logical nodes (Pxxx = logical nodes for protection = **PTEF, PZSU, PDIS, VVPH, PTUV, PDPR, PWDE, PUCP, PUEX, PPBR, PPBV, PMSU, PTTR, PROL, PSOL, PIOC, PTOC, PVOC, PPFR, PTOV, PDOV, PVCB, PHIZ, PREF, PSEF, PITF, PDOC, PDEF, PDCO, PPAM, PFRQ, PDIF, PPDF, PLDF, PNDF, PTDF, PBDF, PMDF, and PGDF**)

Upon detection of a dangerous situation, the system then initiates action.

9 List of Abbreviations

Note: Some abbreviations have more than one meaning in the IEC 61850 specification. These are marked with an asterisk (*).

A	Current in Amperes (Amps) *	IEC 61850-7-4
A	Application (p. 983) *	IEC 61850-8-1
a.c.	alternating current	IEC 61850-3
AA	Application Association	IEC 61850-7-1
ACD	ACTivation information of Directional protection	IEC 61850-7-3
acs	Access	IEC 61850-7-4
ACSE	Application Common Service Element	IEC 61850-8-1
ACSI	Abstract Communication Service Interface	IEC 61850-1
ACT	Protection ACTivation information	IEC 61850-7-3
Acu	Acoustic	IEC 61850-7-4
Age	Ageing	IEC 61850-7-4
AIS	Air Insulated Switchgear	IEC 61850-1
Alm	Alarm	IEC 61850-7-4
ALPDU	Application Layer Protocol Data Unit	IEC 61850-9-1
Amp	Current – non phase related	IEC 61850-7-4
An	Analog	IEC 61850-7-4
ANCR	Logical node - Earth fault neutralizer control (control of Petersen coil)	IEC 61850-5
Ang	Angle	IEC 61850-7-4
APCI	Application Protocol Control Information	IEC 61850-9-2
APDU	Application Protocol Data Unit	IEC 61850-9-2
API	Application Program Interface	IEC 61850-7-1
APPID or AppID	Application Identification	IEC 61850-7-1, IEC 61850-8-1
A-Profile	Application Profile	IEC 61850-8-1
ARCO	Logical node - Reactive control	IEC 61850-5
ASDU	Application Service Data Unit	IEC 61850-1
ASG	Analog SettinG	IEC 61850-7-3
ASN.1	Abstract Syntax Notation One	IEC 61850-7-1
ATCC	Logical node - Automatic tap changer control	IEC 61850-5
AUI	Attachment Unit Interface, Transceiver, or connecting cable	IEC 61850-9-1
Auth	Authorization	IEC 61850-7-4
Auto	Automatic	IEC 61850-7-4

Aux	Auxiliary	IEC 61850-7-4
Av	Average	IEC 61850-7-4
AVCO	Logical node - Automatic voltage control	IEC 61850-5
AZVT	Logical node - Zero-voltage tripping	IEC 61850-5
B	Bushing	IEC 61850-7-4
Bat	Battery	IEC 61850-7-4
BDA	Basic Data Attribute, that is not structured	IEC 61850-6
Beh	Behavior	IEC 61850-7-4
BER	Basic Encoding Rules ASN.1	IEC 61850-9-1
Bin	Binary	IEC 61850-7-4
Blk	Block, or Blocked	IEC 61850-7-4
Bnd	Band	IEC 61850-7-4
Bo	Bottom	IEC 61850-7-4
BOOLEAN		IEC 61850-7-3, IEC 61850-7-2
BR	Functional constraint - Buffered report	IEC 61850-7-2
BRC	Buffered Report Control class	IEC 61850-7-2
BRCB	Buffered Report Control Block	IEC 61850-7-2
BS	Bitstring	IEC 61850-9-2
BufTm		IEC 61850-7-1
c	Conditional support. The item shall be implemented if the stated condition exists	IEC 61850-9-2
CAD	Computer Aided Design	IEC 61850-4
CALH	Logical node - Alarm handling (creation of group alarms and group events)	IEC 61850-5
Cap	Capability	IEC 61850-7-4
Capac	Capacitance	IEC 61850-7-4
Car	Carrier	IEC 61850-7-4
CB	Circuit Breaker	IEC 61850-1
CBB	Conformance Building Block	IEC 61850-8-1
CD ROM	Compact Disc Read Only Memory	IEC 61850-4
CDC	Common Data Class	IEC 61850-1
CDCAName	Common Data Class Attribute Name	IEC 61850-8-1
cdcNs	common data class Name space	IEC 61850-7-3
CDCNSpace	Common Data Class Name Space	IEC 61850-7-2
CE	Cooling Equipment	IEC 61850-7-4
Cf	Crest factor	IEC 61850-7-4
CF	Functional constraint - Configuration	IEC 61850-7-2
Cfg	Configuration	IEC 61850-7-4
CFI	Canonical Format Identifier	IEC 61850-9-2
CG	Core Ground	IEC 61850-7-4
Ch	Channel	IEC 61850-7-4

Cha	Charger	IEC 61850-7-4
Chg	Change	IEC 61850-7-4
Chk	Check	IEC 61850-7-4
Chr	Characteristic	IEC 61850-7-4
CILO	Logical node - Interlocking function (at station level and/or bay level)	IEC 61850-5
CIM	Common Information Model of IEC 61970-301	IEC 61850-6
Cir	Circulating	IEC 61850-7-4
CL	Connectionless	IEC 61850-8-1
Clc	Calculate	IEC 61850-7-4
Client-CR	Client Conformance Requirement	IEC 61850-8-1
Clk	Clock or Clockwise	IEC 61850-7-2
Cls	Close	IEC 61850-7-4
Cnt	Counter	IEC 61850-7-4
CO	Functional constraint - Control *	IEC 61850-7-2
CO	Connection Oriented (p. 983) *	IEC 61850-8-1
CODED ENUM	Ordered set of values, defined where type is used (custom extensions not allowed)	IEC 61850-7-3, IEC 61850-7-2
Col	Coil	IEC 61850-7-4
ConfRev	Configuration revision	IEC 61850-7-1
ConNode	Connectivity Node	IEC 61850-6
Cor	Correction	IEC 61850-7-4
CPOW	Logical node - Point-on-wave breaker controller (controls a circuit breaker with point-on-wave switching capacity)	IEC 61850-5
CRC	Cyclic Redundancy Check	IEC 61850-2
Crd	Coordination	IEC 61850-7-4
Crv	Curve	IEC 61850-7-4
CSMA/CD	Carrier Sense Multiple Access/Collision Detection	IEC 61850-9-1
CSWI	Logical node - Switch controller (controls any switchgear, i.e. the devices described by XCBR and XSWI)	IEC 61850-5
CT	Current Transformer/Transducer	IEC 61850-4
Ctl	Control	IEC 61850-7-4
Ctr	Center	IEC 61850-7-4
Cyc	Cycle	IEC 61850-7-4
d.c.	direct current	IEC 61850-3
DA	Data Attribute	IEC 61850-7-2
DAI	Instantiated Data Attribute	IEC 61850-6
DAT	Data Attribute Type	IEC 61850-7-2
dataNs	Data Name Space	IEC 61850-7-3
DataRef	Data Reference	IEC 61850-7-2
DatAttrRef	Data Attribute Reference	IEC 61850-7-2
DatSet	Data set	IEC 61850-7-1
DAType	Data Attribute type	IEC 61850-7-1

DC	Functional constraint - Description	IEC 61850-7-2
dchg	Trigger option for data-change	IEC 61850-7-1
Dea	Dead	IEC 61850-7-4
Den	Density	IEC 61850-7-4
Det	Detected	IEC 61850-7-4
DEX or DExt	De-Excitation	IEC 61850-7-4
DF	Data Frame	IEC 61850-9-1
Diag	Diagnostics	IEC 61850-7-4
Dif	Differential/Difference	IEC 61850-7-4
Dir	Directional	IEC 61850-7-4
Dis	Distance	IEC 61850-7-4
DI	Delay	IEC 61850-7-4
Dlt	Delete	IEC 61850-7-4
Dmd	Demand	IEC 61850-7-4
Dn	Down	IEC 61850-7-4
DNA	Dynamic Namespace Attribute	IEC 61850-8-1
DO	Data Object	IEC 61850-1
DOI	Instantiated Data Object	IEC 61850-6
DORef	Data Object Reference	IEC 61850-6
DPC	Double Point Control	IEC 61850-7-2
DPS	Double Point Status information	IEC 61850-7-1
DPSCO	Double Point Controllable Status Output	IEC 61850-7-4
DQ0	Direct, Quadrature and Zero (0) axis quantities	IEC 61850-7-4
Drag	Drag Hand	IEC 61850-7-4
Drv	Drive	IEC 61850-7-4
DS	Data Set *	IEC 61850-7-2
DS	Device State (p. 867) *	IEC 61850-7-4
Dsch	Discharge	IEC 61850-7-4
DSG	Data Set Group	IEC 61850-9-1
DTD	Document Type Definition	IEC 61850-6
dupd	trigger option for data update	IEC 61850-7-2
Dur	Duration	IEC 61850-7-4
DUT	Device Under Test	IEC 61850-10
EC	Earth Coil	IEC 61850-7-4
ECT	Electronic Current Transformer or transducer	IEC 61850-9-1
EE	External Equipment	IEC 61850-7-4
EF	Earth Fault	IEC 61850-7-4
EMC	Electro Magnetic Compatibility	IEC 61850-1
EMI	Electro Magnetic Interference	IEC 61850-1
Ena	Enabled	IEC 61850-7-4
ENUMERATED	Ordered set of values, defined where type is used (custom extensions allowed)	IEC 61850-7-3, IEC 61850-7-2

EPRI	Electric Power Research Institute	IEC 61850-1
Eq	Equalization or Equal	IEC 61850-7-4
Ev	Evaluation	IEC 61850-7-4
EVT	Electronic Voltage Transformer or transducer	IEC 61850-9-1
Ex or Ext	Excitation *	IEC 61850-7-4
EX	Functional constraint - Extended definition *	IEC 61850-7-2
Ex	External (p. 867) *	IEC 61850-7-4
Exc	Exceeded	IEC 61850-7-4
Excl	Exclusion	IEC 61850-7-4
F/S	Functional Standard	IEC 61850-8-1
FA	Fault Arc	IEC 61850-7-4
Fact	Factor	IEC 61850-7-4
Fan	Fan	IEC 61850-7-4
FAT	Factory Acceptance Test	IEC 61850-4
FC	Functional Constraint	IEC 61850-7-1
FCD	Functionally Constrained Data	IEC 61850-7-2
FCDA	Functionally Constrained Data Attribute	IEC 61850-7-2
fchg	Trigger option for filtered-data change	IEC 61850-7-2
FD	Fault Distance	IEC 61850-7-4
FLOAT32	Range of values and precision as specified by IEEE 754 single-precision floating point	IEC 61850-7-3
FLOAT64	Not Supported	Not Supported
Flt	Fault	IEC 61850-7-4
Flw	Flow	IEC 61850-7-4
FPF	Forward Power Flow	IEC 61850-7-2
Fu	Fuse	IEC 61850-7-4
Fwd	Forward	IEC 61850-7-4
GAPC	Logical node - Automatic process control (a generic, programmable LN for sequences, unknown functions, etc.)	IEC 61850-5
Gen	General	IEC 61850-7-4
GGIO	Logical node - Generic I/O	IEC 61850-5
GI	General interrogation	IEC 61850-7-1, IEC 61850-7-2
GIS	Gas Insulated Switchgear	IEC 61850-1
Gn	Generator	IEC 61850-7-4
Gnd	Ground	IEC 61850-7-4
GO	Functional constraint - Goose control	IEC 61850-7-2
GoCB	Goose Control Block	IEC 61850-7-2
GoEna		IEC 61850-7-1
GOMSFE	Generic Object Models for Substation and Feeder Equipment	IEC 61850-1
GOOSE	Generic Object Oriented Substation Events	IEC 61850-5
GPS	Global Positioning System (time source)	IEC 61850-5

Gr	Group	IEC 61850-7-4
Grd	Guard	IEC 61850-7-4
Gri	Grid	IEC 61850-7-4
GS	Functional constraint - GSSE control	IEC 61850-7-2
GSAL	Logical node - General security application	IEC 61850-5
GsCB	GSSE Control Block	IEC 61850-7-2
GSE	Generic Substation Event	IEC 61850-7-2
GSEM	Generic Substation Event Model	IEC 61850-7-2
GSSE	Generic Substation Status Event	IEC 61850-7-2
GTES	Logical node - Test generator	IEC 61850-5
H	Harmonics (phase related)	IEC 61850-7-4
H2	Hydrogen	IEC 61850-7-4
H2O	Water	IEC 61850-7-4
Ha	Harmonics (non phase related)	IEC 61850-7-4
Hi	High or Highest	IEC 61850-7-4
HMI	Human Machine Interface	IEC 61850-3
HP	Hot Point	IEC 61850-7-4
Hz	Hertz – frequency cycles/second	IEC 61850-7-4
i	Out-of-scope: The implementation of the item is not within the scope of this standard	IEC 61850-9-2
I/O	Status Inputs/Output contacts, or channels	IEC 61850-5
IARC	Logical node - Archiving	IEC 61850-5
ICD	IED Configuration Description	IEC 61850-10
ID	Identifier	IEC 61850-6
IEC	International Electrotechnical Commission	IEC 61850-1
IED	Intelligent Electronic Device	IEC 61850-1
IEEE	Institute of Electrical and Electronic Engineers	IEC 61850-1
IETF	Internet Engineering Task Force	IEC 61850-8-1
IF	Interface (serial)	IEC 61850-5
IHMI	Logical node - Operator interface (control local at bay level/control at station level)	IEC 61850-5
Imb	Imbalance	IEC 61850-7-4
Imp	Impedance (non phase related)	IEC 61850-7-4
In	Input	IEC 61850-7-4
Ina	Inactivity	IEC 61850-7-4
INC	INteger status – Controllable	IEC 61850-7-3
Incr	Increment	IEC 61850-7-4
Ind	Indication	IEC 61850-7-4
Inh	Inhibit	IEC 61850-7-4
Ins	Insulation	IEC 61850-7-4
Int	Integer	IEC 61850-7-4
INT128	Not Supported	Not Supported

INT16	-32 768 to 32 767	IEC 61850-7-2
INT16U	Unsigned integer, 0 to 65 535	IEC 61850-7-3, IEC 61850-7-2
INT24	-8 388 608 to 8 388 607 (for TimeStamp type)	IEC 61850-7-3, IEC 61850-7-2
INT24U	Unsigned integer, 0 to 16 777 215	IEC 61850-7-2
INT32	-2 147 483 648 to 2 147 483 647	IEC 61850-7-3, IEC 61850-7-2
INT32U	Unsigned integer, 0 to 4 294 967 295	IEC 61850-7-3, IEC 61850-7-2
INT8	-128 to 127	IEC 61850-7-3, IEC 61850-7-2
INT8U	Unsigned integer, 0 to 255	IEC 61850-7-3, IEC 61850-7-2
IntgPd	Integrity Period	IEC 61850-7-1, IEC 61850-7-2
IP	Internet Protocol	IEC 61850-3
ISC	Integer Step Controlled position information	IEC 61850-7-3
ISCSO	Integer Status Controllable Status Output	IEC 61850-7-4
ISI	Integer Status Information	IEC 61850-7-3
ISO	International Organization for Standardization	IEC 61850-1
IT	Current x Time product	IEC 61850-7-4
ITCI	Logical node - Remote control interface or telecontrol interface	IEC 61850-5
ITMI	Logical node - Remote monitoring interface or telemonitoring interface	IEC 61850-5
km	Kilometer	IEC 61850-7-4
L	Lower	IEC 61850-7-4
LAN	Local Area Network	IEC 61850-5
LC	LOG CONTROL Class *	IEC 61850-7-2
LC	Logical Connection (p. 217) *	IEC 61850-5
LCB	Log Control Block	IEC 61850-7-2
LD	Logical Device	IEC 61850-7-1
Ld	Lead	IEC 61850-7-4
LD0	Logical Device Zero (0)	IEC 61850-7-2
LDC	Line Drop Compensation	IEC 61850-7-4
LDCR	Line Drop Compensation Resistance	IEC 61850-7-4
LDCX	Line Drop Compensation Reactance (X)	IEC 61850-7-4
LDCZ	Line Drop Compensation Impedance (Z)	IEC 61850-7-4
LDInst	Instantiated Logical Device	IEC 61850-6
ldNs	logical device Name space	IEC 61850-7-3
LED	Light Emitting Diode	IEC 61850-7-4
Len	Length	IEC 61850-7-4
Lev	Level	IEC 61850-7-4
Lg	Lag	IEC 61850-7-4

LG	Functional constraint - Logging	IEC 61850-7-2
Lim	Limit	IEC 61850-7-4
Lin	Line	IEC 61850-7-4
Liv	Live	IEC 61850-7-4
LLC	Logical Link Control	IEC 61850-9-1
LLN0	Logical Node Zero (0)	IEC 61850-7-1
LLNO	Logical node device	IEC 61850-5
LN	Logical Node	IEC 61850-1
LN Name	Logical Node Name	IEC 61850-7-2
LNC	Logical Node Class	IEC 61850-7-2
LNDData	Logical Node Data	IEC 61850-8-1
LNG	Logical Node Group	IEC 61850-7-4
LNInst	Instantiated Logical Node	IEC 61850-6
InNs	logical node Name space	IEC 61850-7-3
Lo	Low	IEC 61850-7-4
LO	LockOut	IEC 61850-7-4
Loc	Local	IEC 61850-7-4
Lod	Load or Loading	IEC 61850-7-4
LogEna		IEC 61850-7-1
LogRef	Log reference	IEC 61850-7-1
Lok	Locked	IEC 61850-7-4
Los	Loss	IEC 61850-7-4
LPDU	Link Protocol Data Unit	IEC 61850-8-1
LPHD	Logical Node PHysical Device	IEC 61850-7-1
LSAP	Link Service Access Point	IEC 61850-9-2
LSDU	Link layer Service Data Unit	IEC 61850-9-1
Lst	List	IEC 61850-7-4
LTC	Load Tap Changer	IEC 61850-7-4
m	Minutes *	IEC 61850-7-4
M or m	Mandatory (p. 983) *	IEC 61850-7-2, IEC 61850-8-1
M/O	Data Object is Mandatory or Optional	IEC 61850-7-4
M= or m=	Mandatory information that shall be equal the original information supplied in the request	IEC 61850-8-1
MAC	Media Access Control	IEC 61850-9-1
MAU	Medium Attachment Unit (Transceiver)	IEC 61850-9-1
Max	Maximum	IEC 61850-7-4
MC	multicast	IEC 61850-7-1
MCAA	MultiCast Application Association	IEC 61850-7-2
Mem	Memory	IEC 61850-7-4
MHAI	Logical node - Harmonics and interharmonics (for example for power quality purpose)	IEC 61850-5

MICS	Model Implementation Conformance Statement	IEC 61850-10
Min	Minimum	IEC 61850-7-4
MJD	Modified Julian Day	IEC 61850-8-1
MMS	Manufacturing Message Specification (ISO 9506)	IEC 61850-5
MMTR	Logical node - Metering (for commercial purpose)	IEC 61850-5
MMXU	Logical node - Measuring (for operative purpose)	IEC 61850-5
Mod	Mode	IEC 61850-7-4
Mot	Motor	IEC 61850-7-4
ms	Milliseconds	IEC 61850-7-4
MS	Functional constraint - Multicast sampled value control	IEC 61850-7-2
MSQI	Logical node - Sequences and imbalances (for example for stability purpose)	IEC 61850-5
Mst	Moisture	IEC 61850-7-4
MSV	Multicast Sampled Value	IEC 61850-6
MSVC	Multicast Sampled Value Control	IEC 61850-7-2
MSVCB	Multicast Sampled Value Control Block	IEC 61850-7-2
MsvID	ID for MSV (Multicast Sampled Value)	IEC 61850-6, IEC 61850-7-1
MT	Main Tank	IEC 61850-7-4
MTTF	Mean Time To Failure	IEC 61850-3
MTTR	Mean Time To Repair	IEC 61850-3
MU	Merging Unit	IEC 61850-9-1
MX	Functional constraint - Measurands (analog values)	IEC 61850-7-2
N	Neutral	IEC 61850-7-4
Nam	Name	IEC 61850-7-4
NCC	Network Control Center	IEC 61850-5
NdsCom		IEC 61850-7-1
Net	Net sum	IEC 61850-7-4
Ng	Negative	IEC 61850-7-4
Nom	Nominal, Normalizing	IEC 61850-7-4
NPL	Name PLate	IEC 61850-7-2
Num	Number	IEC 61850-7-4
O	Optional	IEC 61850-7-2
OCTET STRING	Max. length defined where type is used	IEC 61850-7-3, IEC 61850-7-2
Ofs	Offset	IEC 61850-7-4
Op	Operate/Operating	IEC 61850-7-4
Opn	Open	IEC 61850-7-4
OptFlds	Optional fields	IEC 61850-7-1
OSI	Open Systems Interconnection	IEC 61850-1
Out	Output	IEC 61850-7-4
Ov	Over/Override/Overflow	IEC 61850-7-4

Pa	Partial	IEC 61850-7-4
Par	Parallel	IEC 61850-7-4
PBDF	Logical node - Busbar protection	IEC 61850-5
PC	Physical Connection	IEC 61850-5
Pct	Percent	IEC 61850-7-4
PD	Physical Device	IEC 61850-1
PDCO	Logical node - DC time overcurrent protection	IEC 61850-5
PDEF	Logical node - Directional earth fault protection	IEC 61850-5
PDIF	Logical node - Differential protection	IEC 61850-5
PDIS	Logical node - Distance protection	IEC 61850-5
PDOC	Logical node - AC directional overcurrent protection	IEC 61850-5
PDOV	Logical node - DC overvoltage protection	IEC 61850-5
PDPR	Logical node - Directional power/reverse power protection	IEC 61850-5
PDU	Protocol Data Unit	IEC 61850-7-2
PE	Process Environment	IEC 61850-4
Per	Periodic	IEC 61850-7-4
PF	Power Factor	IEC 61850-7-4
PFRQ	Logical node - Frequency protection	IEC 61850-5
PGDF	Logical node - Generator differential protection	IEC 61850-5
Ph	Phase	IEC 61850-7-4
PHD	PHysical Device	IEC 61850-7-1
PHIZ	Logical node - Earth fault protection/Ground detection	IEC 61850-5
PhPh	Phase to Phase	IEC 61850-7-4
Phy	Physical	IEC 61850-7-4
PICOM	Piece of Information for COMmunication	IEC 61850-1
PICS	Protocol Implementation Conformance Statement (ISO/IEC 8823-2:1994)	IEC 61850-7-2
PIOC	Logical node - Instantaneous overcurrent or rate of rise protection	IEC 61850-5
PITF	Logical node - Interturn fault protection	IEC 61850-5
PIXIT	Protocol Implementation eXtra Information for Testing	IEC 61850-7-2
PLDF	Logical node - Differential line protection	IEC 61850-5
Pls	Pulse	IEC 61850-7-4
Plt	Plate	IEC 61850-7-4
PMDF	Logical node - Motor differential protection	IEC 61850-5
Pmp	Pump	IEC 61850-7-4
PMSU	Logical node - Motor start-up protection	IEC 61850-5
PNDF	Logical node - Restricted earth fault protection	IEC 61850-5
Po	Polar	IEC 61850-7-4
Pol	Polarizing	IEC 61850-7-4
pos	Position	IEC 61850-7-4
POW	Point On Wave Switching	IEC 61850-7-4

PP	Phase to Phase	IEC 61850-7-4
PPAM	Logical node - Phase angle or out-of-step protection	IEC 61850-5
PPBR	Logical node - Reverse phase or phase balance current protection	IEC 61850-5
PPBV	Logical node - Phase sequence or phase-balance voltage protection	IEC 61850-5
PPDF	Logical node - Phase comparison protection	IEC 61850-5
PpdID		IEC 61850-7-1
PPFR	Logical node - Power factor protection	IEC 61850-5
PPV	Phase to Phase Voltage	IEC 61850-7-4
PREF	Logical node - Rotor earth fault protection	IEC 61850-5
Pres	Pressure	IEC 61850-7-4
Prg	Progress	IEC 61850-7-4
Pri	Primary	IEC 61850-7-4
Pro	Protection	IEC 61850-7-4
PROL	Logical node - Rotor thermal overload protection	IEC 61850-5
Ps	Positive	IEC 61850-7-4
PSEF	Logical node - Stator earth fault protection	IEC 61850-5
PSOL	Logical node - Stator thermal overload protection	IEC 61850-5
Pst	Post	IEC 61850-7-4
PTDF	Logical node - Differential transformer protection	IEC 61850-5
PTEF	Logical node - Transient earthfault protection	IEC 61850-5
PTOC	Logical node - AC time overcurrent protection	IEC 61850-5
PTOV	Logical node - (Time) Overvoltage protection	IEC 61850-5
PTTR	Logical node - Thermal overload protection	IEC 61850-5
PTUV	Logical node - (Time) Undervoltage protection	IEC 61850-5
PUCP	Logical node - Undercurrent/underpower protection	IEC 61850-5
PUEX	Logical node - Loss of field/Underexcitation protection	IEC 61850-5
PurgeBuf		IEC 61850-7-1
PVCB	Logical node - Voltage or current balance protection	IEC 61850-5
PVOC	Logical node - Voltage controlled/dependent time overcurrent protection	IEC 61850-5
PVPH	Logical node - Volt per Hz protection	IEC 61850-5
PWDE	Logical node - Directional earth fault protection for compensated networks based on wattmetric principle	IEC 61850-5
Pwr	Power	IEC 61850-7-4
PZSU	Logical node - Zero speed and underspeed protection	IEC 61850-5
qchg	Trigger option for quality-change	IEC 61850-7-2
Qty	Quantity	IEC 61850-7-4
R or Ra	Rais	IEC 61850-7-4
r	readable	IEC 61850-8-1
R0	Zero Sequence Resistance	IEC 61850-7-4
R1	Positive Sequence Resistance	IEC 61850-7-4

Rat	Ratio *	IEC 61850-7-4
Rat	Winding ration (p. 868) *	IEC 61850-7-4
RBRF	Logical node - Breaker failure	IEC 61850-5
RCB	Report Control Block	IEC 61850-6
Rcd	Record or Recording	IEC 61850-7-4
Rch	Reach	IEC 61850-7-4
Rcl	Reclaim	IEC 61850-7-4
RCPW	Logical node - Carrier or pilot wire protection	IEC 61850-5
RDRE	Logical node - Disturbance recording (bay/process level: acquisition)	IEC 61850-5
RDRS	Logical node - Disturbance recording (station level: evaluation)	IEC 61850-5
Re	Retry	IEC 61850-7-4
React	Reactance	IEC 61850-7-4
Rec	Reclose	IEC 61850-7-4
Red	Reduction	IEC 61850-7-4
Rel	Release	IEC 61850-7-4
Rem	Remote	IEC 61850-7-4
Res	Residual	IEC 61850-7-4
Rest	Resistance	IEC 61850-7-4
RFC	Request For Comments	IEC 61850-8-1
RFLO	Logical node - Fault locator	IEC 61850-5
RIF	Routing Information Field (ISO/IEC 8802-5)	IEC 61850-9-2
Ris	Resistance	IEC 61850-7-4
RI	Relation, relative	IEC 61850-7-4
Rms	Root mean square	IEC 61850-7-4
Rot	Rotation, rotor	IEC 61850-7-4
RP	Functional constraint - Unbuffered report	IEC 61850-7-2
RPF	Reverse Power Flow	IEC 61850-7-4
RPSB	Logical node - Power swing blocking	IEC 61850-5
RptEna	Report enable	IEC 61850-7-1
RREC	Logical node - Automatic reclosing	IEC 61850-5
Rs	Reset, Resettable	IEC 61850-7-4
Rsl	Result	IEC 61850-7-4
Rst	Restraint	IEC 61850-7-4
Rsv	Reserve	IEC 61850-7-4
RSYN	Logical node - Synchrocheck/synchronizing or synchronism check	IEC 61850-5
Rte	Rate	IEC 61850-7-4
Rtg	Rating	IEC 61850-7-4
RTU	Remote Terminal Unit	IEC 61850-4
Rv	Reverse	IEC 61850-7-4
Rx	Receive/Received	IEC 61850-7-4

S	Server specified parameter	IEC 61850-8-1
S1	Step one	IEC 61850-7-4
S2	Step two	IEC 61850-7-4
SA	Substation Automation	IEC 61850-1
SAP	Service Access Point	IEC 61850-8-1
SARC	Logical node - Monitoring and diagnostics for arcs	IEC 61850-5
SAS	Substation Automation System	IEC 61850-1
SAT	Site Acceptance Test	IEC 61850-4
SAV	Sampled Analog Value	IEC 61850-9
SBO	Select Before Operate	IEC 61850-9-1
SC	Secondary Converter	IEC 61850-9-1
SCADA	Supervisory Control And Data Acquisition	IEC 61850-3
SCD	Substation Configuration Description	IEC 61850-10
Sch	Scheme	IEC 61850-7-4
SCL	Substation Configuration description Language	IEC 61850-1, IEC 61850 -8-1
SCO	Supply Change Over	IEC 61850-7-4
SCSM	Specific Communication Service Mapping	IEC 61850-1
SDI	Instantiated Sub DATA; middle name part of a structured DATA name	IEC 61850-6
SE	Functional constraint - Setting group editable	IEC 61850-7-2
Sec	Security	IEC 61850-7-3
Seq	Sequence	IEC 61850-7-4
SeqNum	Sequence number	IEC 61850-7-1
Server-CR	Server-Conformance Requirement	IEC 61850-8-1
Set	Setting	IEC 61850-7-4
SF6	Sulphur HexaFluoride gas	IEC 61850-3
SG	Functional constraint - Setting group	IEC 61850-7-2
SGC	Setting Group Control class	IEC 61850-6
SGCB	Setting Group Control Block	IEC 61850-7-2
Sh	Shunt	IEC 61850-7-4
SIG	Status Indication Group	IEC 61850-9-1
SIMS	Logical node - Insulation medium supervision	IEC 61850-5
SmpRate	Sample rate	IEC 61850-7-1
SMV	Sampled Measured Value	IEC 61850-6
SMVC	Sampled Measured Value Control	IEC 61850-7-2
NTP	Network Time Protocol	IEC 61850-8-1
SoE	Sequence of Events	IEC 61850-7-1
Sp	Speed	IEC 61850-7-4
SP	Functional constraint - Setpoint	IEC 61850-7-2
SPC	Single Point Control	IEC 61850-7-4
SPCSO	Single Point Controllable Status Output	IEC 61850-7-4

Spd	Speed	IEC 61850-7-4
SPDC	Logical node - Monitoring and diagnostics for partial discharge	IEC 61850-5
SPI	Single Pole	IEC 61850-7-4
SPS	Single Point Status information	IEC 61850-7-1
Src	Source	IEC 61850-7-4
SSYS	Logical node - System supervision	IEC 61850-5
ST	Functional constraint - Status information	IEC 61850-7-2
St	Status	IEC 61850-7-4
Stat	Statistics	IEC 61850-7-4
Std	Standard	IEC 61850-7-4
STIM	Logical node - Time master	IEC 61850-5
Stop	Stop	IEC 61850-7-4
Str	Start	IEC 61850-7-4
Sts	Stress	IEC 61850-7-4
Sup	Supply	IEC 61850-7-4
SUT	System Under Test	IEC 61850-10
SV	Functional constraint - Sampled Value Substitution	IEC 61850-7-2
Svc	Service	IEC 61850-7-4
SVC	Sampled Value Control	IEC 61850-6
SvEna		IEC 61850-7-1
Sw	Switch	IEC 61850-7-4
Swg	Swing	IEC 61850-7-4
Syn or Sync	Synchronization	IEC 61850-7-4, IEC 61850-8-1
T	Transient data *	IEC 61850-7-4
T	Transport or Timestamp (p. 983) *	IEC 61850-8-1
TAI	Temps Atomique International	IEC 61850-8-1
Tap	Tap	IEC 61850-7-4
TCI	TeleControl Interface *	IEC 61850-5
TCI	Tag Control Information (p. 1114, 1152) *	IEC 61850-9-2
TCP	Transmission Control Protocol	IEC 61850-3
TCP/IP	Transmission Control Protocol / Internet Protocol	IEC 61850-3
TCTR	Logical node - Current transformer	IEC 61850-5
Td	Total distortion	IEC 61850-7-4
Tdf	Transformer derating factor	IEC 61850-7-4
TE	Telecommunication Environment	IEC 61850-4
Test	Test	IEC 61850-7-4
Thd	Total harmonic distortion	IEC 61850-7-4
Thm	Thermal	IEC 61850-7-4
Tif	Telephone influence factor	IEC 61850-7-4
Tm	Time	IEC 61850-7-4
Tmh	Time in hours	IEC 61850-7-4

TMI	TeleMonitoring Interface (for example to engineer's work-station)	IEC 61850-5
Tmm	Time in minutes	IEC 61850-7-4
Tmms	Time in milliseconds	IEC 61850-7-4
Tmp	Temperature	IEC 61850-7-4
Tms	Time in seconds	IEC 61850-7-4
To	Top	IEC 61850-7-4
Tot	Total	IEC 61850-7-4
TP	Three Pole *	IEC 61850-7-4
TP	Two-party (p. 621) *	IEC 61850-7-3, IEC 61850-7-2
TPAA	Two Party Application Association	IEC 61850-7-2
TPID	Tag Protocol Identifier *	IEC 61850-9-2
TPID	Priority Tagging Identification (for IEEE 802.1Q networks) = 0x8100 (p. 983) *	IEC 61850-8-1
T-Profile	Transport Profile	IEC 61850-8-1
Tr	Trip	IEC 61850-7-4
Trg	Trigger	IEC 61850-7-4
TrgOp	Trigger Option	IEC 61850-7-2
TrgOpEna	Trigger Option Enabled	IEC 61850-7-2
TrgOps	Trigger options	IEC 61850-7-1
Ts	Total signed	IEC 61850-7-4
Tu	Total unsigned	IEC 61850-7-4
TVTR	Logical node - Voltage transformer	IEC 61850-5
Tx	Transmit/Transmitted	IEC 61850-7-4
Typ	Type	IEC 61850-7-4
U or u	User-specific: Indicates that the service, parameter, or attribute can be defined by an implementation	IEC 61850-8-1
U= or u=	User-specific information that shall be equal the original information supplied in the request	IEC 61850-8-1
UCA TM	Utility Communications Architecture	IEC 61850-7-2
UML	Unified Modelling Language	IEC 61850-7-1
Un	Under	IEC 61850-7-4
UNICODE STRING	Max. length defined where type is used	IEC 61850-7-3
URC	Unbuffered Report Control	IEC 61850-7-2
URCB	Unbuffered Report Control Block	IEC 61850-7-2
URI	Universal Resource Identifier	IEC 61850-6
US	Functional constraint - Unicast sampled value control	IEC 61850-7-2
USMVC	Unicast Sampled Measured Value Control	IEC 61850-7-2
USV	Unicast Sampled Value	IEC 61850-6
USVC	Unicast Sampled Value Control	IEC 61850-7-2
USVCB	Unicast Sampled Value Control Block	IEC 61850-7-2

UsvID	ID for USV (Unicast Sampled Value)	IEC 61850-6
UTC	Co-ordinated Universal Time	IEC 61850-7-2
V	Voltage	IEC 61850-7-4
VA	Volt Amperes	IEC 61850-7-4
Vac	Vacuum	IEC 61850-7-4
Val	Value	IEC 61850-7-4
Var	Volt Amperes reactive	IEC 61850-7-4
VARSPEC	Variable Specification	IEC 61850-8-1
V-Get	Virtual Get function (ISO 9506-1)	IEC 61850-8-1
VID	VLAN IDentifier	IEC 61850-9-2
VISIBLE STRING	Max. length defined where type is used	IEC 61850-7-3, IEC 61850-7-2
VLAN	Virtual Local Area Network	IEC 61850-9-2
Vlv	Valve	IEC 61850-7-4
VMD	Virtual Manufacturing Device	IEC 61850-8-1
Vol	Voltage (non phase related)	IEC 61850-7-4
V-Put	Virtual Put function (ISO 9506-1)	IEC 61850-8-1
VT	Voltage Transformer/Transducer	IEC 61850-4
W	Watts active power	IEC 61850-7-4
w	writeable	IEC 61850-8-1
Wac	Watchdog	IEC 61850-7-4
Watt	Active power (non phase related)	IEC 61850-7-4
Wei	Week end infeed	IEC 61850-7-4
Wh	Watt hours	IEC 61850-7-4
Wid	Width	IEC 61850-7-4
Win	Window	IEC 61850-7-4
Wrm	Warm	IEC 61850-7-4
X	Excluded: The user shall not implement this item	IEC 61850-9-2
X0	Zero sequence reactance	IEC 61850-7-4
X1	Positive sequence reactance	IEC 61850-7-4
XCBR	Logical node - The LN 'circuit breaker' covers all kinds of circuit breakers, i. e. switches able to interrupt short circuits	IEC 61850-5
XML	eXtensible Mark-up Language	IEC 61850-1
XSWI	Logical node - The LN 'switch' covers all kinds of switching devices not able to switch short circuits	IEC 61850-5
XX	Functional constraint - Wildcard representing all DataAttributes as a service parameter	IEC 61850-7-2
YEFN	Logical node - Earth fault neutralizer (Petersen coil)	IEC 61850-5
YLTC	Logical node - Tap changer	IEC 61850-5
YPSH	Logical node - Power shunt	IEC 61850-5
YPTR	Logical node - Power transformer	IEC 61850-5
Z	impedance	IEC 61850-7-4
Z0	Zero sequence impedance	IEC 61850-7-4

Z1	Positive sequence impedance	IEC 61850-7-4
ZAXN	Logical node - Auxiliary network	IEC 61850-5
ZBAT	Logical node - Battery	IEC 61850-5
ZBSH	Logical node - Bushing	IEC 61850-5
ZCAB	Logical node - Power cable	IEC 61850-5
ZCAP	Logical node - Capacitor bank	IEC 61850-5
ZCON	Logical node - Converter	IEC 61850-5
Zer	Zero	IEC 61850-7-4
ZGEN	Logical node - Generator	IEC 61850-5
ZGIL	Logical node - Gas isolated Line (GIL)	IEC 61850-5
ZLIN	Logical node - Power overhead line	IEC 61850-5
ZMOT	Logical node - Motor	IEC 61850-5
Zn	Zone	IEC 61850-7-4
ZREA	Logical node - Reactor	IEC 61850-5
Zro	Zero sequence method	IEC 61850-7-4
ZRRC	Logical node - Rotating reactive component	IEC 61850-5
ZSAR	Logical node - Surge arrestor	IEC 61850-5
ZTCF	Logical node - (Thyristor controlled) frequency converter	IEC 61850-5
ZTCR	Logical node - Thyristor controlled reactive component	IEC 61850-5

10 Glossary of Terms

Symbols & Numeric

(n)-Layer

Any specific layer.

(n)-Protocol

Set of rules and formats (semantic and syntactic) which determines the communication behavior of (N)-entities in the performance of (n)-functions.

(n)-Protocol Data Unit

Unit of data specified in an (n)-protocol and consisting of (n)-protocol-control-information and possibly (n)-user-data.

A

Access Point

Communication access point to an IED. This may be a serial port, an Ethernet connection, or a client or server address dependent on the stack being used. Each access point of an IED to a communication bus is uniquely identified. Each server has only one logical access point.

Active master

Interface allowing communication with IEDs (Intelligent Electronic Devices) that use any protocol. The interface works by standardizing attributes of all possible functions, so that these can be mapped to functions used by the IED.

Application and Transport Profiles (A-Profile and T-Profile)

Set of protocols for a specific purpose.

Application Layer

Layer 7 in the OSI reference model. It is the OSI layer closest to the end user, providing an interface between the Open Systems Interconnection environment and the end user's application.

Association

Conveyance path established between a client and a server for the exchange of messages.

Attribute

Named element of data which has a specific type.

B

Bay

Collection of components of a substation with common functionality.

Bay Level Functions

Functions that pertain to a bay. The bay level represents an additional layer of control below the overall substation level. These functions communicate via the logical interface 3 within the bay level and via the logical interfaces 4 and 5 to the process level, i.e. with any kind of remote I/Os or intelligent sensors and actuators. Interfaces 4 and 5 may be hardwired also but hardwired interfaces are beyond the scope of the IEC 61850 series.

Broadcast

Message sent to all nodes on a network.

Bus

Communication system connection between IEDs with communication facilities.

C

Class

Description of a set of objects that share the same attributes, services, relationships and semantics.

Client

A workstation on a network that requests services from a server and that receives unsolicited messages from a server.

Communication Connection

Connection which utilizes the communication mapping function of one or more resources for the conveyance of information.

Communication Stack

Also called protocol stack. Multi-layer stack. In the 7-layer OSI reference model for Open Systems Interconnection, each layer performs specific functions related to Open Systems Interconnection communication.

Communication System

Interconnected set of all communication links.

Configuration

The assignment of values to parameters of a system or device that determine its function and operation.

Configuration List

Overview of all compatible hardware and software versions of components and IEDs, including the software versions of relevant supporting tools, operating together in a SAS product family. Additionally, the configuration list details the supported transmission protocols for communication with IEDs of other manufacturers.

Conformance Test

Check of data flow on communication channels in accordance with the standard conditions concerning access organization, formats and bit sequences, timing, signal form and level, and reaction to errors. The conformance test can be carried out and certified to the standard or to specifically described parts of the standard. The conformance test should be carried out by an ISO 9001 certified organization or system integrator.

Connection

Association established between functional units for conveying information.

Connectivity Node

An identifiable, named, common connection point between terminals of primary devices whose only function is to connect them electrically with minimum resistance; for example, a busbar as a connectivity node connects bus bar disconnectors. The connection to a device is done at a device terminal. A connectivity node can connect an arbitrary number of terminals (devices).

Cyclic Redundancy Check (CRC)

A check for transit damage in frames. It is calculated and included in each frame transmitted by the sending device, and recalculated by the receiving device.

D**Data**

Meaningful, structured, information of applications, located in an IED, which can be read or written.

Data Attribute

Property of data that defines its name (semantic), format, range of possible values, and representation of values while being communicated.

Data Class

Class that aggregates data classes or Data Attributes. Specific data classes carry the semantic within a logical node.

Data Link Layer

Layer 2 of the OSI reference model for Open Systems Interconnection, responsible for the transmission of data over a physical medium. After establishment of a link, layer 2 performs data rate control, error detection, contention/collision detection, quality of service monitoring and error recovery.

Data Object

A data structure that is part of a logical node and represents specific information.

Data Set Class

Named list of ordered references to one or more Functionally Constrained Data (FCD) or Functionally Constrained Data Attributes (FCDA). Used to group commonly used data objects for easy retrieval.

Device

Piece of equipment or tool designed to perform one or more specific tasks.

Diameter

Refers to a 1 1/2 breaker arrangement and comprises the complete switchgear between the two bus bars, i.e. the 2 lines and the 3 circuit breakers with all related isolators, earthing switches, CTs and VTs. It has some common functionality and relationship both for operation, maintenance and extensions.

Distributed Functions

Functions performed by collaboration of two or more logical nodes that are located in different physical devices. Since all functions communicate in some way, the definition of a local or distributed function is not unique but depends on the definition of the functional steps to be performed until the function is completed. In the case of loss of one LN or one included communication link, the function may be blocked completely or show a graceful degradation, as applicable.

Distribution

The part of the power system operating at voltages typically up to 69 kV.

E

Electronic Current Transducer

Transducer in the primary plant that measures system current and provides low-level analog and/or digital output(s).

Electronic Voltage Transducer

Transducer in the primary plant that measures system voltage(s) and provides low-level analog and/or digital output(s).

Engineering

First phase of a project, i.e. detail design.

Engineering Tools

These support the creation and documentation of the conditions for adapting the SAS to the specific substation and customer requirements. The engineering tools are divided into project management, parameterization and documentation tools.

Equipment

Entity that performs an energy transport function, for example: transformer, circuit breaker, line. It may be stand-alone or interfaced to an automation system via an integral device or associated external device.

Expandability

The ability of a system to rapidly and efficiently extend to accommodate new hardware and/or software.

EXtensible Mark-up Language (XML)

High-level language that can be used to construct plain-text file formats describing application-specific structured data. This enables data files to be generated and read by a computer, and which are also human legible.

XML is independent of platform, for example, hardware, software, and application, and provides free-extensibility. XML file readers (browsers) are available that are non-proprietary.

F

Factory Acceptance Test

Customer-agreed functional tests of the specifically manufactured SAS installation or its parts, using the parameter set for the planned application. This test should be carried out in the factory of the system integrator by use of process-simulating test equipment.

Flexibility

Ability of a system to rapidly and efficiently implement functional changes, including hardware adaptation.

Freeze

To lock and hold a value at that instant. Typically used with measurands and counters.

Functional Constraint

Property of a Data Attribute that indicates the services that may be applied to that Data Attribute, for example: read value, write value, substitute value, etc.

Functionally Constrained Data

An ordered collection of data having the same functional constraint, for example: all MX (measurands).

Functionally Constrained Data Attribute

A Data Attribute to which a specific functional constraint applies.

Functions

Tasks performed by automation systems and their components.

G**Gateway**

Network interconnection device that supports the full stack of the relevant protocol which it can convert to a non-7-layer protocol for asynchronous transmission over wide area networks.

Generic Object Oriented Substation Event

A report by exception multicast sent by an IED in response to a change of state in the system. It is high-speed binary object, typically containing the double command state of each of its status inputs, starters, output elements and relays, actual and virtual. A GOOSE report enables high speed trip signals to be issued with a high probability of delivery.

Generic Substation Event Model

Defines two classes of multicast/broadcast data, i.e. GOOSE and GSSE, for the fast transfer of input and output data values between IEDs.

Generic Substation State Event

Similar to GOOSE but restricts the contained-data to data values of a number of double-command (bit pairs) status values, for example: open, closed, in transition, or invalid states.

H**Hold Point**

Point, defined in the appropriate document, beyond which an activity must not proceed without the written approval of the initiator of the conformance test. The test facility must provide a written notice to the initiator at an agreed time prior to the hold point. The initiator, or his representative, is obligated to verify the hold point and approve the resumption of the testing.

Hub

A central device that connects multiple computers on a single network. Each port of a hub links individual media segments together to create a larger network that operates as a single LAN. Collisions in the network are possible.

Human Machine Interface (HMI)

Display screen, either part of an IED or as a stand-alone device, presenting relevant process data to a human operator, with which the operator interacts. An HMI typically presents windows, icons, menus, pointers, and may include a keypad to enable user access and interaction.

|

IED Parameter Set

All the parameter values needed for the definition of the behavior of the IED and its adaptation to the substation conditions. Where the IED has to operate autonomously, the IED-parameter set can be generated without system parameters using an IED-specific parameterization tool. Where the IED is a part of the SAS, the IED-parameter set may include system parameters, which must be coordinated by a general parameterization tool at the SAS level.

Implementation

Development phase in which the hardware and software of a system become operational.

Information Model

Knowledge concerning substation functions (devices) made visible and accessible through the means of the IEC 61850 series. The model describes in an abstract way a simplified representation of a real function or device.

Inspection

Activity such as measuring, examining, testing or gauging of one or more characteristics of an entity and comparing the results with specified requirements in order to establish whether conformity is achieved for each characteristic.

Instance

Entity that has a unique identity, with the attributes of a defined class, to which a set of services can be applied and which has a state that stores the effects of the services. 'Instance' is synonymous with 'object.'

Instance Name

Identifier associated with and designating an instance.

Instantiation

Creation of an instance of a specified class.

Intelligent Electronic Device (IED)

Device that contains at least one processor and that can exchange data with other Intelligent Electronic Devices.

Interchangeability

Ability to replace a device supplied by one manufacturer with a device supplied by another manufacturer, without making changes to the other elements in the system.

Interface

A boundary across which two systems communicate using common functional characteristics, for example: common physical interconnection or signal characteristics.

Interface Related Station Level Functions

Functions representing the interface of the SAS local station operator HMI (Human Machine Interface) to a remote control center Tele-Control Interface (TCI) or to the remote engineering Tele-Monitoring Interface (TMI) for monitoring and maintenance purposes. These functions communicate via the logical interfaces 1 and 6 with the bay level and via logical interface 7 to technical services and via the remote control interface to the outside world. Logically, there is no difference if the HMI is local or remote. In the context of the substation, there exists at least a virtual interface for the SAS at the boundary of the substation. The same is true for both the TCI and TMI. These virtual interfaces may be realized in some implementations such as proxy servers.

Internet Protocol

TCP/IP standard internet protocol defines the datagram that provides the basis of connectionless packet delivery. It includes control and error message protocol providing the equivalent functions to network services, layer 3, of the OSI reference model for Open Systems Interconnection.

Interoperability

Ability of two or more IEDs from the same vendor, or different vendors, to exchange information and use that information for correct execution of specified functions.

ISO/IEC 8802-3

Communication technology according to ISO/IEC 8802-3.

L

Life Cycle

All phases from the feasibility/concept phase through to the final decommissioning phase.

Link Layer

See Data Link Layer.

Local Area Network (LAN)

Communications network which typically covers the area within a building or small industrial complex. In the context of the IEC 61850 standard, the area within the substation.

Log

Record of chronologically ordered data, for example: events with time tags and annotations.

Logical Connection

Communication link between logical nodes.

Logical Device

Entity that represents a set of typical substation functions.

Logical Device Class

Virtual device that exists to enable aggregation of related logical nodes and dataset(s) for communication purposes. In addition, logical devices contain convenient lists of frequently accessed, or referred to, information, for example: data sets.

Logical Device Object

Instance of the logical device class.

Logical Node

Smallest component of a function that exchanges data. A logical node is an object defined by its data and methods.

Logical Node Class

Aggregation of data, data sets, report controls, log controls, logs, GOOSE and GSSE controls and sampled measured values. Logical node classes represent typical functions of the substation system. IEC 61850-7-4 defines a list of compatible logical node classes for protection functions, supervisory control, metering, switchgear, power transformers, etc.

Logical Node Data

Information contained within a logical node. The term encompasses ACSI data, control blocks, etc.

Logical Node Object

Instance of a logical node class.

Logical System

Set of all application functions performing some overall task and communicating via its logical nodes, for example, 'management of a substation.' The boundary of a system is given by its logical or physical interfaces. Examples are industrial systems, management systems, information systems, etc.

M

Mapping

Defined association or linkage of two separate entities or sets of values by means of assigned correlation of individual elements from the first set to individual elements of the second set.

Merging unit

Physical unit performing the time-coherent combination of the current and/or voltage data coming from the secondary converters. The merging unit can be part of one of the transducers in the field or may be a separate unit, for example in the control room.

Message

Inherent attribute of a communication between IEDs, functions or instances, that conveys service-specific data or commands, on receipt of which it is expected that action is taken.

Model

A simplified representation of some aspects of reality. The purpose of creating a model is to facilitate understanding, description, or prediction of something that is difficult or impossible to directly observe in the real world, by providing the opportunity for exploration of a simplified representation of a particular entity or phenomenon.

Model Implementation Conformance Statement

Details the standard data object models supported by the system or device.

Multicast

Uni-directional, connectionless communication between a server and a selected set of clients.

N

Name Plate

Name for the set of data typically found on an item of a plant (for example, a power transformer) or on an IED (for example, a protection relay) that uniquely describes that device's identity and attributes.

Negative Test

Test to verify the correct response of a device or system to the following standards:

- IEC 61850-conformant information and services which are not implemented in the device or system under test
- Non-IEC 61850-conformant information and services sent to the device or system under test

Network Layer

Layer 3 of the OSI reference model for Open Systems Interconnection. It provides functional and procedural means of connectionless or connection-mode transmission, also independence from routing and communications-relaying considerations, enabling the transparent transfer of data between transport entities.

O

Object Attribute

Field or a category or value of data that, together with other attributes, specify the services or data values related to the function and performance of an object.

Object Name

Unique full reference identifier of a specific data object that is unique within the SAS domain, or within a specific domain. It is constructed by concatenation, using dot '.' delimiters, to as many hierarchical levels as required, for example, 'BasicDataClass.StructuredComponent.X.X.X.X.etc'

Object/Instance

Descriptor of an instance of a class of entity that is uniquely identifiable within the SAS domain, with defined boundaries and identity which encapsulates states and behavior. States are represented by attributes, behavior by services and state machines.

Open Protocol

Protocol whose stack is either standardized or publicly available.

P

Parameters

Variables which define the behavior of functions of the SAS and its IEDs within a given range of values.

Physical Connection

Communication link between physical devices.

Physical Device

Entity that represents the physical parts of a device (hardware and operating system, etc.). Physical devices host logical devices. Equivalent to an Intelligent Electronic Device (IED) as used in the context of the IEC 61850 Standard.

Physical Layer

Layer 1 of the OSI reference model for Open Systems Interconnection. It provides the mechanical, electrical, functional and procedural means to activate, maintain and deactivate physical connections for bit transmission between data-link entities. Physical layer entities are interconnected by means of a physical medium.

Physical Node

Point of connection on a physical device to a communication network. A physical node is a multi-functional unit providing both the communication server and the mapping to the real substation IED.

Physical System

A system composed of the IEDs and the interconnecting physical communication network (commonly fiber optics). The boundary of a system is given by its logical or physical interfaces. Examples are industrial systems, management systems, information systems, etc.

Piece of Information for Communication (PICOM)

PICOM is a description of an information transfer on a given logical connection with given communication attributes between two logical nodes. It also contains the information to be transmitted and required attributes, for example, performance. It does not represent the actual structure or format of the data that is transmitted over the communication network. The PICOM approach was adopted from the CIGRE working group 34.03.

Point to Point

One-to-one communication link between two nodes, used only for communication between those two nodes.

Positive Test

Test to ensure the correct implementation of the system capabilities as defined by the supplier. A positive test has a described and defined response.

Presentation Layer

Layer 6 of the OSI reference model for Open Systems Interconnection. It provides an interface between the concrete local syntax used by the Application layer and the negotiated abstract and transfer syntaxes to be used for the transfer of data during a communication session between the two communicating application entities.

Primary System

Common term for all power system equipment and switchgear.

Process Level Functions

All functions interfacing to the process, i.e. binary and analog input/output functions, for example: data acquisition (including sampling) and the issuing of commands. These functions communicate via the logical interfaces 4 and 5 to the bay level.

Process Related Station Level Functions

Functions that use data from more than one bay, or from the whole substation, and act on the primary equipment of more than one bay, or on the primary equipment of the whole substation. Examples of such functions are: station-wide interlocking, automatic sequencers, and busbar protection. These functions communicate mainly via the logical interface 8.

Process Related Station Level Functions

Functions using the data of more than one bay or of the complete substation, and acting on the primary equipment of more than one bay, or of the complete substation. Examples of such functions are station-wide interlocking, automatic sequencers or busbar protection. These functions communicate mainly via the logical interface 8.

Profile(s)

Defined format(s) used by a particular protocol to transmit data objects or commands, etc.

Protocol

Set of rules that determines the behavior of functional units in achieving communication.

Protocol Converter

Intelligent Electronic Device connected between two communication networks, that is capable of translating messages received in one protocol on one network to a second protocol for retransmission on the other network and vice versa.

Protocol Data Unit

Encoded message containing the service parameters.

Protocol Implementation Conformance Statement

Summary of the capabilities of the system to be tested.

Protocol Implementation Extra Information for Testing

Document (PIXIT) containing system-specific information regarding the capabilities of the system to be tested which are outside the scope of the IEC 61850 series. Provides information regarding the physical set-up that is not part of the ACSI. This could be information regarding the hardware, socket, and other information. The PIXIT shall not be subjected to standardization.

R

Redundant/Redundancy

Existence of more than one means for performing a required function. A spare or duplicate functionality that allows a system to continue to operate without degradation of performance in the event of a single failure, for example, a blown fuse.

Remote Terminal Unit

Typically an outstation in a SCADA system, a Remote Terminal Unit (RTU) may act as an interface between the communication network and the substation equipment. The function of an RTU may reside in one IED or may be distributed.

Report

Client-defined, set of data compiled by an IED for transmission to a client at regular or specified time intervals, or on demand. A report may also be generated as a result of one or more trigger conditions that may be either pre-set or pre-defined by the client.

Review

Systematic examination, as defined in the appropriate document, of the quality document(s) for an activity. The test facility must provide the documentation to be reviewed to the initiator of the conformance test at an agreed time prior to the associated hold or witness point. How the review is conducted is subject to agreement.

S

SAS Installation

Concrete instance of an SAS consisting of multiple, interoperable IEDs from one or more manufacturers.

SAS Parameter Set

All the parameters needed for the definition of the behavior of the overall SAS and its adaptation to the substation conditions. The SAS parameter set includes the IED parameter sets of all participating IEDs.

SAS Product Family

Range of different IEDs from one manufacturer, with various functionalities and with the ability to perform substation automation system functions. The IEDs of a product family are unified in relation to the design, the operational handling, the mounting and wiring requirements and they use common or coordinated supporting tools.

Scalability

Criterion for a cost-effective SAS, taking into account the various functionalities, IEDs, substation sizes and substation voltage ranges.

Secondary System

Interaction set of all components and systems in the substation for the operation, protection, and monitoring of the primary system. In case of full application of numerical technology, the secondary system is synonymous with the substation automation system (SAS).

Selector

Defines the references to a class instance for accessing the instance values.

Self-Description

Device contains information on its configuration. The representation of this information has to be standardized and has to be accessible via communication (in the context of the IEC 61850 series).

Server

On a communication network, a functional node that provides data to, or that allows access to its resources by, other functional nodes. A server may also be a logical subdivision, which has independent control of its operation, within the software algorithm (and/or possibly hardware) structure.

Server Class

External visible behavior of an IED or application process.

Service

Functional capability of a resource which can be modeled by a sequence of service primitives.

Service Access Point

Represents a logical construct through which a peer selects a communication protocol or access to an application. The selection of the entire seven layers of a service access point represents a communication profile.

Service Primitive

Abstract, implementation-independent representation of an interaction between the service user and the service provider.

Session Layer

Layer 5 of the OSI reference model for Open Systems Interconnection. It manages the establishment and release of session connections, and also the synchronization of data exchange between presentation entities.

SF6

Sulphur Hexafluoride gas, used as an insulating medium in gas-insulated circuit breakers and associated plant.

Site Acceptance Test

Verification of each data and control point and the correct functionality inside the SAS and between the SAS and its operating environment on the whole installed plant using the final parameter set. The site acceptance test is the pre-condition for the SAS being accepted and put into service.

Specific Communication Service Mapping

Standardized procedure which provides the concrete mapping of ACSI services and objects onto a particular protocol stack/communication profile.

To reach interoperability, it is intended to have a minimum number of profiles and corresponding Specific Communication Service Mapping (SCSM). Special application sub-domains such as 'station bus' and 'process bus' may result in more than one mapping. However, for the specific protocol stack selected, only one single SCSM and one single profile should be specified.

A SCSM shall detail the instantiation of abstract services into protocol-specific single service or sequence of services that achieve the service as specified in ACSI.

Additionally, a SCSM shall detail the mapping of ACSI objects into objects supported by the application protocol.

SCSMs are specified in IEC 61850-8-x and IEC 61850-9-x.

State Machine

The functional behavior of any IED, logical node or object, can be defined and delineated by means of a state machine. This describes, normally by means of a state diagram, the functionality, responses, actions and reactions, as a series of discrete, linked states, together with the criteria governing the transition from one state to another specific state.

Station Level Functions

Functions applying to the whole substation. There are two classes of station-level functions, i.e. process-related station-level functions and interface-related station-level functions.

Subdevice

Part of a primary device, for example one phase of a three-phase device.

Subnetwork

Communication system connection between IEDs which have serial communication facilities. All devices connected to a subnetwork can directly communicate to each other, without an intervening router. Routers or gateways can connect subnetworks.

Subscribed Data

Data that a client has requested to be supplied on a regular basis, or when trigger condition(s) are satisfied.

Substation Automation System (SAS)

System which operates, protects, and monitors the substation. It includes the IEDs and communication network infrastructure. It uses fully numerical technology and serial communication links.

Substation Master

IED that functions either as a RTU or provides a centralized function, for example time-synchronizing reference.

Supporting Tools

Support the user in the engineering, the operation and the management of the SAS and its IEDs. The supporting tools can perform the following tasks: engineering, project management, parameter change, diagnostics, testing, documentation, and other services.

Usually the supporting tools are part of the SAS and they run on an IED (for example, PC).

Switch

Active network component that connects two or more subnetworks, which themselves could be built of several segments connected by repeater. Switches establish the borders for so-called collision domains. Collisions cannot take place between networks divided by switches, as data packets destined to a specific subnetwork do not appear on the other subnetworks. To achieve this, switches must have knowledge of the hardware addresses of the connected stations. In cases where only one active network component is connected to a switch port, collisions on the network can be avoided.

System

Set of interacting entities which perform a common functionality. Its backbone is some communication mechanism.

System Integrator

Turnkey deliverer of SAS installations. The responsibility of system integration includes the engineering, the delivery and mounting of all participating IEDs, the factory and site acceptance tests and the trial operation. The quality assurance, maintenance and spares delivery obligations, and the warranty shall be agreed upon in the contract between the system integrator and the customer.

System Life Cycle

Has two independent meanings:

For the manufacturer - the time period between the start of the production of a newly developed SAS product family and the discontinuation of support for the IEDs

For the customer - the time period between the commissioning of an SAS installation mainly based on a SAS product family and the decommissioning of the latest SAS installation from the same family

System Parameters

Data that defines the interaction of IEDs in the SAS. They are especially important in the definitions for configuration of the SAS, communication between IEDs, for marshalling of data between IEDs, for processing and visualization of data from other IEDs, for example at the station level, and for parameterization.

System Test

Check of correct behavior of the IEDs and of the overall SAS under various application conditions. The system test marks the final stage of the development of IEDs as part of a SAS product family.

T

Telecommunication Environment

Communication interfaces associated with telecommunications.

Telecommunications Interface

Interface point to the telecommunications network link to the remote power system network control center.

Telemonitoring Interface

Communications link to a monitoring engineer's workplace.

Test Equipment

Tools and instruments which simulate and verify the inputs/outputs of the operating environment of the SAS, such as switchgear, transformers, network control centers or connected telecommunication units on the one side, and the communication channels between the IEDs of the SAS on the other.

Test Facility

Organization which is able to provide appropriate test equipment and trained staff to perform conformance testing. The management of conformance tests and the resulting information should follow a quality system and a test facility should be certified in accordance with IEC 61850-10.

Test Item

One single test step from the sequence of tests defined to verify compliance.

Transient Data

Pertaining to or designating a phenomenon or a quantity which varies between two consecutive states during a time interval short compared to the time-scale of interest. Data objects with this designation only exist at the time they occur and must be logged to prove the evidence of their existence.

Transmission

The part of the power system operating at voltages of typically 110 kV and above.

Transport Layer

Layer 4 of the OSI reference model for Open Systems Interconnection. It establishes the transport connection and addressing, controls and monitors the data rate flow and the release of the transport connection. Enables variable size data files to be seamlessly transported.

Type Test

Verification of correct behavior of the IEDs of the SAS by use of the system tested software under the environmental test conditions stated in the technical data. This test marks the final stage of IED hardware development and is the precondition for the start of full production. This test must be carried out with IEDs that have been manufactured through the normal production cycle.

U

Unicast/Point to Point

Communication between a server and a single client.

Unified Modeling Language

Standardized constructs and semantics for diagrams, including state machines, which are used to describe/specify the functionality of an IED, object model or a process.

Unsolicited Data or Unsolicited Message

Data or message which is supplied to a client from a server without the client subscribing to that data or message, for example: reset, abort, time. Does not require a connection to be established.

Utility Communications Architecture

Describes the concepts of standardized models for power system objects.

W

Witness Point

Point, defined in the appropriate document, at which an inspection takes place on an activity. The activity may proceed without the approval of the initiator of the conformance test. The test facility must provide a written notice to the initiator at an agreed time prior to the witness point. The initiator or his representative has the right, but is not obligated, to verify the witness point.

11 Support, Service & Warranty

11.1 Contacting Technical Support

ProSoft Technology, Inc. is committed to providing the most efficient and effective support possible. Before calling, please gather the following information to assist in expediting this process:

- 1 Product Version Number
- 2 System architecture
- 3 Network details

If the issue is hardware related, we will also need information regarding:

- 1 Module configuration and associated ladder files, if any
- 2 Module operation and any unusual behavior
- 3 Configuration/Debug status information
- 4 LED patterns
- 5 Details about the interfaced serial, Ethernet or Fieldbus devices

Note: For technical support calls within the United States, ProSoft Technology's 24/7 after-hours phone support is available for urgent plant-down issues.

North America (Corporate Location) Phone: +1.661.716.5100 info@prosoft-technology.com Languages spoken: English, Spanish REGIONAL TECH SUPPORT support@prosoft-technology.com	Europe / Middle East / Africa Regional Office Phone: +33.(0)5.34.36.87.20 france@prosoft-technology.com Languages spoken: French, English REGIONAL TECH SUPPORT support.emea@prosoft-technology.com
Latin America Regional Office Phone: +52.222.264.1814 latinam@prosoft-technology.com Languages spoken: Spanish, English REGIONAL TECH SUPPORT support.la@prosoft-technology.com	Asia Pacific Regional Office Phone: +60.3.2247.1898 asiapc@prosoft-technology.com Languages spoken: Bahasa, Chinese, English, Japanese, Korean REGIONAL TECH SUPPORT support.ap@prosoft-technology.com

For additional ProSoft Technology contacts in your area, please visit:
www.prosoft-technology.com/About-Us/Contact-Us.

11.2 Warranty Information

For complete details regarding ProSoft Technology's TERMS & CONDITIONS OF SALE, WARRANTY, SUPPORT, SERVICE AND RETURN MATERIAL AUTHORIZATION INSTRUCTIONS, please see the documents at:
www.prosoft-technology.com/legal